

Monthly adventure role-playing aid

# Dragon<sup>®</sup>

\$3.50

#111

Murder-mystery module  
A new kind of magic item  
DUNGEON™ Adventures



394-24363-97580330



Wizards  
of the Coast





# The Quest Continues...

TALISMAN, the classic fantasy boardgame, is back in a stunning second edition - now with full colour cards to create even more atmosphere for adventurers everywhere.

And available at last to all TALISMAN addicts - the TALISMAN EXPANSION SET. More characters, spells, objects and events to make TALISMAN even more of a challenge. Seventy new cards altogether, plus a FREE poster of the fantastic new cover artwork!

# TALISMAN

TALISMAN and the TALISMAN EXPANSION SET from GAMES WORKSHOP.  
Available now from all good games shops, or send SAE for full mail order details to:  
Games Workshop/Citadel Miniatures Mail Order, Chewton St, Hilltop, Eastwood, Notts, UK;  
or: Games Workshop US, 9110F Red Branch Rd, Columbia, MD21045, USA.



# Rolemaster™

## THE CLASSIC FRP SYSTEM FROM IRON CROWN ENTERPRISES, INC.

ROLEMASTER™, a complete Fantasy Role Playing system in one box, is the most detailed, consistent and flexible set of FRP guidelines available.

The ROLEMASTER™ box set includes:

- **SPELL LAW™**— A complete magic system with over 2000 spells for 15 character classes utilizing 3 realms of power.
- **ARMS LAW & CLAW LAW™**— A system with all the elements of realistic armed and unarmed combat including weapons, armor, animals and critical strikes.
- **CHARACTER LAW & CAMPAIGN LAW™**— A comprehensive character generation system along with reference material invaluable to Gamemasters.
- A free **LOREMASTER™** module.

Part of the ROLEMASTER™ system, but sold separately is **CREATURES & TREASURES™**, which details 3 key areas of FRP: creatures, treasures, and random encounters with both.

ROLEMASTER™; use it wholly or in part. It stands alone or adds depth to your current system.



Distributed to the hobby trade in the U.K. by CHRIS HARVEY GAMES, GAMES OF LIVERPOOL, VIRGIN GAMES & GAMES WORKSHOP LTD. Distributed by JEDKO GAMES in Australia, BLACKWOOD GAYLE in New Zealand, TARGET GAMES AB in Sweden, CITADEL in West Germany, PACIFIC ENTERPRISE ITALIA in Italy, and POST HOBBY CO. LTD. in Japan.

ROLEMASTER™ ... a cut above the rest.



IRON CROWN ENTERPRISES / P.O. BOX 1605 / CHARLOTTESVILLE, VA 22902

- PLEASE RUSH ME: U.S. \$
- SPELL LAW .....\$12.00
  - ARMS LAW & CLAW LAW .....\$12.00
  - CHARACTER & CAMPAIGN LAW .....\$12.00
  - ROLEMASTER BOX (includes all of the above).....\$34.00
  - CREATURES & TREASURES ...\$12.00

NAME \_\_\_\_\_  
STREET \_\_\_\_\_  
CITY \_\_\_\_\_ STATE \_\_\_\_\_ ZIP \_\_\_\_\_  
PHONE \_\_\_\_\_

Orders up to \$49.99 add \$1.25 postage & handling, orders of \$50.00 or more add \$2.50. Canadians add (U.S.) \$2.50 on all orders. Send check or money order, no cash or COD. VISA & MASTERCARD orders call (800) 325-0479. VA residents, Canadians & overseas customers call (804) 295-3917. Send \$1.00 for color catalog.

Copyright 1986 IRON CROWN ENTERPRISES, INC.



77



41

*Publisher*  
Mike Cook

*Editor-in-Chief*  
Kim Mohan

*Editorial staff*  
Patrick Lucien Price  
Roger Moore  
Robin Jenkins

*Editorial assistance*  
Eileen Lucas

*Art, graphics, production*  
Roger Raupp  
Kim Lindau  
Gloria Szopinski

*Advertising*  
Mary Parkinson

*Subscriptions*  
Pat Schulz

*This issue's contributing artists*

Denis Beauvais  
Dennis Kauth  
Valerie Valusek  
Marvel Bullpen  
Jeff Butler  
DC Comics staff  
Larry Elmore  
Ted Goff  
Richard Tomasic  
Denton Elliott  
Joseph Pillsbury  
Dave Trampier



Monthly adventure role playing aid  
**Dragon**

**SPECIAL ATTRACTION**

- 4 1 **Death of an Arch-Mage** — *Michael D. Selinker*  
A murder-mystery module for the AD&D® game

**OTHER FEATURES**

- 8 **Good stuff, for a spell**— *John M. Maxstadt*  
Magic-focusing items: a new concept in treasure
- 1 4 **Welcome to Malachi** — *Becky Helfenstein*  
A "game city" designed with magic in mind
- 1 8 **DUNGEON™ Adventures** — *Roger E. Moore*  
Everything there is to say about our new publication
- 2 2 **No campaign ever fails**— *Joel E. Roosa*  
How to recognize and correct an uncontrolled campaign
- 2 7 **Microscopic monsters** — *Kent Colbath*  
— Single-celled organisms take on monstrous proportions
- 35 **The role of books** — *Reviews by John C. Bunnell*
- 6 6 **Pull the pin and throw** — *Kevin Marzahl*  
Grenades explode onto the TOP SECRET® game scene
- 7 2 **File Under 'B'** — *Esther M. Friesner*  
Love, magic — and a barbarian by the card catalog!

**THE ARES™ SECTION**

- 78 **Phoenix™** — *Roger E. Moore*  
Bright and dark in the Marvel Universe™
- 8 2 **Maxima** — *Jack Herman*  
Back from the future in the V&V™ game
- 8 4 **Supergirl™** — *Greg Gorden*  
The Maid of Steel in the DC HEROES game
- 8 8 **The Marvel®-Phile** — *Jeff Grubb*  
An advanced look at a long shot
- 90 **Quantum** — *George MacDonald*  
A quantum leap in CHAMPIONS™ gaming

**DEPARTMENTS**

- |                      |                        |                 |
|----------------------|------------------------|-----------------|
| 3 Letters            | 64 TSR Profiles        | 97 Snarfquest   |
| 4 World Gamers Guide | 94 Gamers' Guide       | 100 Dragonmirth |
| 6 The forum          | 96 Convention calendar | 102 Wormy       |
| 62 TSR Previews      |                        |                 |

**COVER**

High above the clouds, away from the interference of men and other landlubbers, "The Conflict" rages. Our latest offering from Denis Beauvais depicts two deadly dragons locked in a struggle that mirrors the battle between good and evil. We'll let you decide which dragon is the good one; all that matters to us is the artwork itself — and the artwork is *great!*



# Letters

## Dust does the job

Dear Dragon,

I have two questions about articles in issue #109. First of all I wanted to know if you are able to see a displacer beast with *dust of appearance*. Second, about "The role of books": Can I buy some of these books through you?

Trent Raley  
Poway, Calif.

*Since dust of appearance "negates the effects of cloaks of displacement" (DMG, p. 143), it's safe to assume that it will also spoil the power of a displacer beast. The creature's true form will become visible, and it won't be able to "displace" for the duration of the effect of the dust.*

*The books we review are not available for sale from DRAGON Magazine or TSR, Inc. — unless, of course, TSR published the book. You should be able to find any of them in your local bookstore, or if they aren't on the shelves the proprietor of the store can usually place an order for a specific title. — KM*

## His and hers

Dear Dragon,

In "The barbarian cleric" (issue #109), I only remember seeing masculine pronouns when describing actions, ownership, etc. Is it possible to have a female cleric, or don't the tribes allow female clerics?

Also, concerning "Worth its weight in gold": How do dwarves react to half-dwarves (if possible) and half-elves that may grow beards?

Bill Voshell  
Marydel, Md.

*In most of the articles we publish, masculine pronouns are used to refer to both sexes, because constructions such as "his or hers" and "he or she" are usually cumbersome and hard to read through. ("If confronted by a monster, he or she will draw his or her sword. . . ." See what I mean?) If an author writes "he or she" and the usage doesn't seem to disrupt the flow of the article, we will often use the words as they were written, which is why you sometimes see that construction in these pages. Otherwise, unless the context obviously indicates that only the masculine gender is referred to, you can assume that "he" stands for "he or she," and so forth. Is it possible to have a female barbarian cleric? Sure, if you assume that women can attain positions of prominence within the tribe.*

*About dwarves and beards: As far as I know, the half-dwarf has not been described as a racial type in the AD&D® game. It's certainly possible for you to develop a half-dwarf in your campaign, but if you do, then you'll have to decide how that race fits into the scheme of things. And how do dwarves react to half-elves with beards? I suppose pretty much the same way they react to any bearded non-dwarf: The beard certainly doesn't hurt, but if the person under the beard isn't a*

*dwarf, no amount of facial hair is going to gain him the same level of acceptance that a dwarf would be able to attain. — KM*

## Two kinds of art

Dear KM,

After we received issue #109, my wife pointed something out to me. She said, "When there is a female on the cover, she is generally scantily clad and well proportioned, but when there is a guy on the cover he is covered from head to toe and looks like a jerk."

I'm inclined to agree with her after looking back in retrospect. She would like to see some nice-looking guys on the cover — "a hunk." I have no problem with that. It might even entice some more women to get into the game.

Another thing I have to say has to do with when you started making posters available of the front covers: Bravo for "Lady Valshea"! More should become available! I can't say enough — the Lady Valshea poster is beautiful!

Scott P. Devine  
Salem, Mass.

*Practically all of our cover paintings fall into one of two categories; let's call them "fine art" and "game art." Fine art is just that: a painting that is rendered with such a high degree of technical excellence that we can't pass it up. That category includes, but is not limited to, paintings of scantily clad, well-proportioned women, such as Keith Parkinson's "Lady Valshea" (#106).*

*Game art must also be well rendered, but has an extra element that makes it even more attractive to us: it depicts a scene that could occur in a game context. "Attack of the Taer" by Daniel Horne (#109) features a monster from the AD&D® game and a man who is wisely (considering the circumstances) outfitted in the best armor his gold pieces could buy*

*We don't go out looking for fine art, but if someone shows us a beautiful painting we'll consider it. The cover of this issue, by the way, is fine art: As you're probably already noticed, those aren't "game" dragons that Denis Beauvais has depicted — but how could we turn down such a striking piece of art?*

*We do actively solicit game art; in fact, Daniel Horne produced "Attack of the Taer" in response to our specific request for something game-related. (And if you liked that painting, wait till you see his next one.)*

*If someone shows us a painting of a "hunk," and it strikes us as something we'd be proud to print, then we'll do that. But if that hunk is engaged in combat with a monster, he'd better be wearing more than a scowl and a loincloth.*

*On the subject of posters, I have to set the record straight: "Lady Valshea" was **not** offered for sale by DRAGON Magazine, and we (the magazine) have no plans to get into the poster business. We have encouraged several of our cover artists to make posters available, however, and we recently got word that Robin Wood is doing just that; see the space at the right. — KM*

## Robin won, Robin too

Wipe that puzzled frown off your face and keep reading. I know that title doesn't make any sense by itself, but as the crystal-ball salesman said to his customer, everything will become clear shortly.

Recently we evaluated a lot of intelligent, energetic people for an opening on our editorial staff, and Robin won — Robin Jenkins, that is. He was playing the D&D® game before DRAGON® Magazine existed, and now he's putting all that experience to work as the newest member of our team.

Essentially, Robin is picking up where Roger Moore left off. Roger has moved into his new role as editor of DUN-GEON™ Adventures, about which a lot more is said beginning on page 18. Robin has taken custody of our eternally replenishing pile of manuscript submissions, and will put his gaming experience and editorial training to use determining which ones are fit to print. If he likes it, he shows it to me, and if I like it, we show it to you. The process is simple, but some of the decisions are pretty tough, and I'm glad to have Robin here to help us make them.

A few months ago, Keith Parkinson broke the ice by being the first DRAGON Magazine cover artist to sell posters of his work. And now, the roster of artist/entrepreneurs includes Robin too — Robin Wood, that is. She called a while ago to let us know that "Music Lover" (issue #97) is being produced for sale as an 11" x 14" poster.

Each print will be numbered and signed by the artist, shrink-wrapped in protective plastic, and mailed flat. The limited-edition prints will be sold to the first 250 people who send a \$35 payment to Robin at 80 Princeton Arms North 1, Cranbury NJ 08512. If the demand turns out to be greater than the supply, Robin says she'll make extra prints (unsigned and unnumbered) available for \$25 each, and people who ordered the \$35 print will be given a chance to buy one of the less expensive versions and receive a rebate. Since "Music Lover" is one of the most popular covers we've printed in the last year or so, I expect the prints to sell fast; if you want one, order it soon.

I hope that this news will spur some of our other artists into marketing their paintings as posters, too. That means you, Denis . . . and you, Clyde . . . and you, Larry . . . and Dean . . . and . . .

# The World Gamers Guide

If you live outside the continental United States and Canada, you can be included in the World Gamers Guide by sending your name and full address, plus your gaming preferences, to World Gamers Guide, DRAGON® Magazine, P.O. Box 110, Lake Geneva WI 53147 USA.

Abbreviations in parentheses after a name indicate games in which that person is especially interested:

AD = AD&D® game; DD = D&D® game; CC = CALL OF CTHULHU®

game; GW = GAMMA WORLD® game; SF = STAR FRONTIERS® game; ST = STAR TREK®: The Role-Playing Game; MSH = MARVEL SUPER HEROES™ game; TS = TOP SECRET® game; T = TRAVELLER® game; RQ = RUNEQUEST® game; VV = VILLAINS & VIGILANTES™.

The World Gamers Guide is intended for the benefit of gamers who live outside the continental United States and Canada, in areas where nearby gamers are small in number or nonexistent, as a

way for them to contact other game-players who would be interested in corresponding about the activities that they enjoy. Unfortunately, we cannot extend this service to persons who live in remote areas of the U.S. or Canada, or to U.S. military personnel with APO or FPO addresses. Each eligible name and address that we receive will be published in three consecutive issues of DRAGON® Magazine; to be listed for more than three issues, you must send in another postcard or letter.

William Vernon (AD,CC)  
Avenida Sojo  
Residencies El Escorial  
1<sup>er</sup> piso, #12  
Urbanizacion El Rosal  
Caracas 1060  
Venezuela

Shane Huang I  
P.O. Box 36-158  
Taipei, Taiwan  
R.O.C.

Markus Teltscher (AD,SF)  
Hainkopfstr. 20  
6233 Kelkheim-Eppenhain  
West Germany

Haris Firoz (DD,AD)  
No. 1 Jalan Benar  
86000 Kluang,  
Johore,  
West Malaysia

Russel Davidoff (AD)  
110 Greenlands Cres.  
Sunningdale  
Johannesburg 2192  
South Africa

Sequoia Hall (AD,GW,SF)  
P.O. Box 3263  
Agana, Guam 96910

Margot Aflague (AD,TS,T)  
Box 24384  
GMF, Guam 96921

Masayuki Kitano (AD,DD,GW)  
190-28 Yakuoji  
Tawaramoto-Cho  
Shiki-Gun, 636-03 Nara  
Japan

Matthew Strickler (AD,DD,TS)  
Impasse-de Mon Idee 3  
1226 Thonex  
Switzerland

Kazuo Hikoyoshi (DD)  
3-13-8-607 Kaminoge  
Setagaya-ku  
Tokyo 158  
Japan

Grant I. Fraser (AD,DD,GW)  
11 Dallow Place  
Henderson Auckland 8  
New Zealand

Ho Chung Hsi (DD,AD,SF)  
2 Arbuthnot Rd.,  
1st floor, front block,  
Central District  
Hong Kong

Dragons Domain (AD,SF,GW)  
56 Woodstock Street  
Guildford 2161  
N. S. W. Australia

P. J. Juster (AD,DD,T)  
30/5 Arbel St.  
P.O. Box 326  
Karmiel, Israel 20101

Craig Robinson (DD,AD,GW)  
P.O. Box 320  
Atherton 4883  
Queensland, Australia

L. W. Hansen (AD,DD)  
B.S. Ingemannsvej 2, Vaer. 74  
6400 Sonderborg  
Denmark

Tina de Jesus (AD)  
30 Mangyan Road  
La Vista, Diliman  
Quezon City  
Philippines

Jeff Johnson  
SPDC Ext. Nord  
B.P. 31  
Maroua  
l'Extreme-Nord  
Cameroun

Peter S. Magnusson (AD)  
Ankarvagen 7  
181 43 Lidingso  
Sweden

Ng Chi Ho (DD,MSH)  
Flat F. 12/F  
On Lok Garden Mansion  
47 Yuet Wah Street  
Kwun Tong, Kowloon  
Hong Kong

Jeremy Phillips (AD,T,GW)  
2 Bryan Ave.  
Kilkenny 5009  
South Australia  
Australia

Winfried Eller (AD,CC,DQ)  
Silbegasse 43  
6901 Wilhelmsfeld  
West Germany

Venezuelan Role-Playing  
Society (AD,VV,T)  
Avenida Francisco de Miranda  
Edificio Galipan, Chacao  
Caracas 1060  
Venezuela

DRAGON® Magazine (ISSN 0279-6848) is published monthly by TSR, Inc. The mailing address for all material except subscription orders is DRAGON Magazine, P.O. Box 110, Lake Geneva WI 53147; the business telephone number is (414) 248-3625. DRAGON Magazine is available at hobby stores and bookstores throughout the United States and Canada, and through a limited number of overseas outlets. Subscription rates via second-class mail are as follows: \$24 in U.S. funds for 1 year (12 issues) sent to an address in the U.S. or Canada, \$55 for 12 issues sent by surface mail to any other address, and \$95 for 12 issues sent airmail to any other address. Payment in full must accompany all subscription orders. Methods of payment include checks or money orders made payable to TSR, Inc., or charges to valid MasterCard or VISA credit cards. Send subscription orders with payments to: TSR, Inc., P.O. Box 72089, Chicago IL 60690. A limited quantity of back issues are available from the TSR mail order department, P.O. Box 756, Lake Geneva WI 53147. For a copy of the current catalog listing available back issues, write to the mail order department at the above address. The issue of expiration of each subscription is printed on the mailing label for each subscriber's copy of the magazine. Changes of address for the delivery of subscription copies must be received at least six weeks prior to the effective date of the change in order to assure uninterrupted delivery. All material published in DRAGON Magazine becomes the exclusive property of the publisher, unless special arrangements to the contrary are made prior to publication. DRAGON Magazine welcomes unsolicited submissions of written material and artwork; however, no responsibility for such submissions can be assumed by the publisher in any event. Any submission accompanied by a self-addressed, stamped envelope of sufficient size will be returned if it cannot be published.

DRAGON is a registered trademark for the monthly adventure playing aid published by TSR, Inc. All rights to the contents of this publication are reserved, and nothing may be reproduced from it in whole or in part without first obtaining permission in writing from the publisher. Copyright ©1986 TSR, Inc. All Rights Reserved.

AD&D, D&D, TOP SECRET, GAMMA WORLD, and STAR FRONTIERS are registered trademarks owned by TSR, Inc. ARES is a trademark owned by TSR, Inc. All Marvel characters and the distinctive likenesses thereof are trademarks of the Marvel Comics Group. MARVEL SUPER HEROES and MARVEL SUPER VILLAINS are trademarks of the Marvel Comics Group. Copyright ©1986 Marvel Comics Group, a division of Cadence Industries Corporation. All Rights Reserved. Supergirl and all DC character names, renditions, associated slogans, and indicia are trademarks of DC Comics Inc. Copyright ©1983 DC Comics Inc. All Rights Reserved. CHAMPIONS is a trademark of Hero Games. Quantum is copyright ©1986 George MacDonald. VILLAINS & VIGILANTES is a trademark of Fantasy Games Unlimited. Maxima is copyright ©1986 Jack Herman. Other trademarks are the property of TSR, Inc., unless otherwise indicated.

Second-class postage paid at Lake Geneva, Wis., and additional mailing offices. Postmaster: Send address changes to TSR, Inc., P.O. Box 110, Lake Geneva WI 53147. USPS 318-790, ISSN 0279-6848.



# Come play with us.



A Supplement for Pendragon

(Pendragon game 2301-X \$19.95)

Enter the world of Arthur, King of all Britain and master of a thousand knights.

Explore the beauty and splendor of the legendary world of Camelot and the Round Table; experience its magic and mystery.

Come, play with us.

(2704) THE KING ARTHUR COMPANION — \$19.95

Written in a warm and entertaining style, *The King Arthur Companion* contains almost 700 entries, fully cross-referenced and annotated. It includes a "who's who" of Arthurian legend; a "what's what" of famous weapons and artifacts; a "where's where" of many geographical locations from actual maps of ancient Britain; and a "when's when" full chronology of Arthur's reign.



Available at Hobby & Game Stores Everywhere

# Chaosium Inc.

Box 6302 Albany, California 94706-0302

IN THE U.S.A. — order direct from Chaosium Inc. Please list game title and product number. Include list price plus \$2.00 for postage and handling. All payments must be in U.S. funds or by MASTERCARD or VISA. No COD. Call [415] 547-7681 to order by phone. Prices subject to change without notice. Allow two to four weeks for delivery.

IN THE UNITED KINGDOM — order direct from Games Workshop, Chewton Street, Hilltop, Eastwood, Nottingham. For ACCESS and VISA orders ring the Mail Order Hotline on (0773) 769522.

# The forum

Let me congratulate you on your excellent editorial taste in choosing to publish Bruce Humphrey's "The role of nature" in issue #108. Back when I penned "Weather in the World of Greyhawk," I hoped that someone would go beyond my (admittedly sketchy) appendices on the effects of heat and cold and examine *all* the environmental issues. Mr. Humphrey has done so, and quite nicely, making the two articles a well-matched pair.

While I agree with almost all of Mr. Humphrey's work, there are a few thoughts I'd like to add. First of all, while he speaks of the effects of humidity in hot climates, he ignores it in the cold — a critical omission. Compare cold weather in the American Plains states with that along a seacoast such as that of Norway or Newfoundland, and you'll see what I mean.

What effects will the humidity have? Well, moist climates tend to be more disease-ridden, no matter what the temperature, because the airborne water provides a home for assorted microbes. Influenza, pneumonia, and tuberculosis (not to mention the common cold) are examples of diseases that thrive on cold, damp environments. The overall effects of both high and low temperatures tend to be exaggerated by humidity, and preservation of foodstuffs and valuable substances like silk will be harder in any moist climate, due to the increased likelihood of organic rot and mildew. One of the few advantages of such a clime is that tracking is often simplified, due to the softness of the ground, though mists and fogs may balance out this benefit by reducing vision.

Mr. Humphrey argues that ". . . hard work helps keep you warm in cold weather." While there's some truth to this, it's also important to recognize that overwork in such an environment can lead to serious illness. A form of heat prostration is also possible, as the extra layers of clothing prevent the evaporation of sweat. In general, the time needed for rest and recovery from physical labor will be 1½ to 2 times as long in cold climates as it would in temperate areas, and a corresponding increase in appetite is also expectable.

I fully agree with Mr. Humphrey's notion that elementals and their kin will pose a problem when they are summoned into "improper" environs, even under situations that would normally imply absolute control. I would even go a step further, and suggest that a druid who summoned a fire elemental into a cold environment or an earth elemental into a wet area would be risking the wrath of his or her deity for misuse of a valuable spell. In my own world, summoned animals or insects that are brought into a climate to which they are not native only have half their normal effects.

A form of heat damage the article omits is the inhalation of superheated air, which causes burns within the throat and lungs. In real life, this is the cause of more fire-related deaths than actual contact with flames, and is a problem separate from that of smoke inhalation, which Mr. Humphrey did cover. Also relevant here is the fact that hot fires lasting more than a few rounds will

easily consume the oxygen in an enclosed, unventilated area, leading to the effects described under "Terrain" on page 17.

Mr. Humphrey's approach to lightning is, I think, a bit too severe. Though the natural bolts he describes are far weaker than those of a medium-level mage in terms of immediate effect, the additional damage he adds in is excessive. For consistency, a DM using this method should also apply it to all spells involving lightning, and even to the damage done by monsters with electrical attacks.

While the two articles do differ slightly on the effects of some events, these discrepancies are far from critical. The DM should simply choose the approach which best fits his or her campaign, making sure that the choice is consistent with the rest of the world, and proceed with the campaign.

David M. Axler  
Philadelphia, Pa.

I'm writing in response to Bryan Winter's letter on akasa existing in a "modern world." Bryan seemed to be looking for a method of justifying the use of magic in a modern world. I have developed a system that could be applied to a campaign in the modern world. We must first look at the source of power of magic-users and clerics.

A magic-user gains his power by learning how to manipulate certain things such as nature, the elements, and many other things. He does this by combining specific vocal, somatic, and material components to invoke the desired effect. Thus, he gains his power from his knowledge of how the components work together. Cantrips are a "first step" for the magic-user into the realm of magic use. They learn how to perform minor tricks by waving their hands or combining certain things. This becomes the basis of spellcasting. As they practice and train, they learn how to gain a more powerful result from their combination of components. In this, we also see the need for a magic-user to have a high intelligence. It is needed to retain all the information gained from training and experience. So, the power of the magic-user is gained from his own knowledge, and he would be able to cast a spell anywhere provided he had the components and the knowledge of how to cast the spell.

As for clerics, they are also required to have vocal, somatic, and material components to cast a spell. They, however, gain the knowledge on how to cast the spell from their deities. Thus, the cleric does not need a high intelligence to cast a spell, but he needs a high wisdom which will permit him to become close to his deity. If a cleric should go to a modern world, of course, the deity could grant him a spell. If the mortal 1st-level cleric went to the modern world, why couldn't the immortal all-powerful deity, with his instantaneous, unlimited-range, innate ability of teleportation, go there? The deity being too far away shouldn't be a problem since the planes that the deities exist on are infinite. So, a cleric on the Prime Material Plane would be an infinite number of miles away. In other words, a cleric of Odin in the Hellfurnaces of Greyhawk would be

just as far away as a drunken bum in a modern world on the Prime Material Plane. The modern world must be accepted as existing on the Prime Material Plane just in a different time. The justification for us mundane people not being able to cast spells is that we do not possess the knowledge of how to use certain components in coordination with each other in order to acquire the desired effect. The only flaw in my theory is the reason why magic-users forget the spell after they cast it. My reasoning is that it is part of the magic but this doesn't satisfy many people. I would be delighted if I could receive other ideas on this subject and constructive criticism is gladly accepted on my whole theory. I know I have omitted many areas of spellcasting, but I consider this to be the basis of it all.

Andy Price  
Miami, Fla.

In his article "Locals aren't all yokels" (issue #109), Ralph Sizer said that the best way to prevent PCs from assaulting the local serfs is to make every third one a 15th level MU. There are more subtle ways to deal with wayward players, however.

For example, threatening the old hermit could result in the party failing to find the location of the exit to the Maze of Darkness. Their next characters won't make the same mistake. Or, the PCs could find themselves without armor, weapons, or shelter as the whole town shuts down in mourning for its recently departed mayor.

This type of DM control encourages good role-playing. Mr. Sizer's method merely helps reduce the game to a brawl.

Jaldhar Uyas  
Jersey City, N.J.

I have not yet bought *Unearthed Arcana* and have now decided I will not do so. I have used it on a number of occasions but I always borrowed a copy from a friend.

I have decided not to use *Unearthed Arcana* when I play the AD&D game. I don't like the new races or classes presented there.

First, the new races presented do not improve the game at all and only serve to complicate the game and upset game balance. The gray dwarf, drow, and deep gnome races have such unbelievable powers innate to their race as player characters that they are strongly upsetting in the game and much too powerful. In a recent DRAGON Magazine, a writer said that these races had to be powerful to be like their monster counterparts. Why include them at all? I have at least six people I DM for and none of them have any desire to play any race outside of those presented in the *Players Handbook*.

Second, there is no need for any more classes. If I want a knight in my campaign he (or she) will be a paladin or a fighter with a set of honorific rules. In my campaign there are special guilds which teach extra skills at the cost of a percentage of experience. Thus, if I want a thief-acrobat (or one of my players wishes to play one), the character can get into a guild that teaches these extra skills at perhaps 20% additional experience. Thus, there is no need for these new classes either: the first eleven are plenty.

Almost everything in *Unearthed Arcana* was from DRAGON Magazine. I suggest you leave them there. We AD&D players could then decide what to use and which classes and races to allow. But now, since it is official, I just won't buy the book.

Scott Paul Maykrantz  
Midland, Mich.



# NEW WORLDS AWAIT YOU

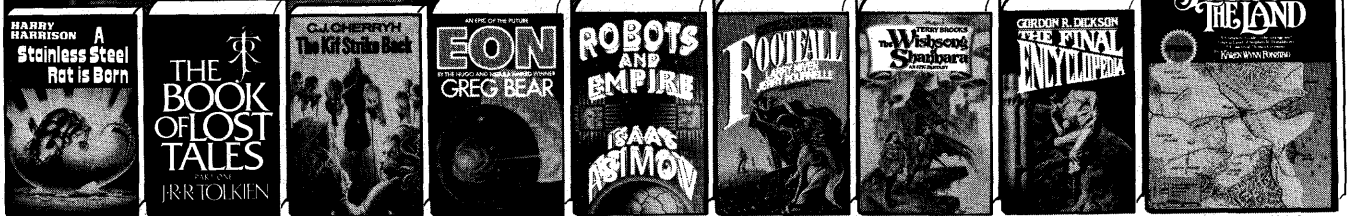

2089 Spec. ed. 1362 Pub. ed. \$14.95 2113 Spec. ed. 2162 Pub. ed. \$16.95 1743 Pub. ed. \$16.95 1883 Pub. ed. \$17.95 1933 Pub. ed. \$18.95 1800 Spec. ed. 1982 Pub. ed. \$19.95

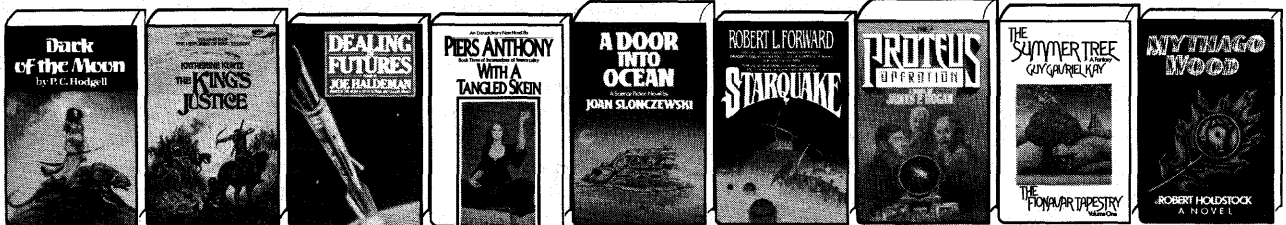

2154 Pub. ed. \$19.95 5264 Pub. ed. \$16.95 5272 Pub. ed. \$16.95 5280 Pub. ed. \$14.95 2097 Pub. ed. \$17.95 2147 Pub. ed. \$14.95 2055 Pub. ed. \$16.95 2048 Pub. ed. \$15.95 1974 Pub. ed. \$14.95



0901 Pub. ed. \$14.95 1917 Pub. ed. \$15.95 2139 Pub. ed. \$15.95 ★ 1925 Spell-singer; The Hour of the Gate; The Day of the Dissonance. Spec. ed. 2105 Escape Velocity; The Warlock in Spite of Himself. Spec. ed. 2121 King Kobold Revived; The Warlock Unlocked; The Warlock Enraged. Spec. ed. 5520 The Sleeping Dragon; The Sword and the Chain; The Silver Crown. Spec. ed. 0943 Another Fine Myth; Myth Conceptions; Myth Directions; Hit or Myth. Spec. ed. 1420 Includes the First, Second and Third Books. Spec. ed.

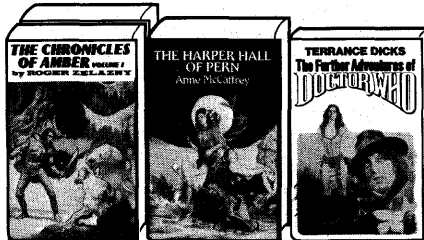

0075 The First 5 Amber Novels. 2 vols. Comb. pub. ed. \$32.30 0992 Dragonsong; Dragonsinger; Dragondrums. Comb. pub. ed. \$38.85 2022 Doctor Who and the Deadly Assassin; Doctor Who and the Face of Evil; Doctor Who and the Robots of Death. Spec. ed.

## Take any 5 books for \$1 with membership

YOURS FREE with membership... 50 full-color bookplates featuring art by Boris Vallejo



COMPLETE AND MAIL THIS COUPON TO:

### SCIENCE FICTION BOOK CLUB®

Dept. BS-268, Garden City, NY 11535

YES, I want the galaxy's greatest selection of SF! Please accept my application for membership in the Science Fiction Book Club. Send me the 5 BOOKS whose numbers I have indicated in the boxes below plus my FREE BOOKPLATES and bill me just \$1 (plus shipping and handling). I agree to the Club Plan as described in this ad. I will take 4 more books at regular low Club prices in the coming year and may resign any time thereafter. The FREE BOOKPLATES will be mine to keep whether or not I remain a member. SFBC offers serious works for mature readers.

1.	2.	3.	4.	5.
----	----	----	----	----

Mr. \_\_\_\_\_  
 Ms. \_\_\_\_\_  
 (Please print)  
 Address \_\_\_\_\_ Apt. # \_\_\_\_\_  
 City \_\_\_\_\_ State \_\_\_\_\_ Zip \_\_\_\_\_

If under 18, parent must sign. \_\_\_\_\_  
 The Science Fiction Book Club offers its own complete hardbound editions sometimes altered in size to fit special presses and save you even more. Members accepted in U.S.A. and Canada only. Canadian members will be serviced from Canada. Offer slightly different in Canada. 04-S019

### How the SCIENCE FICTION BOOK CLUB works:

You'll receive your choice of ANY 5 BOOKS SHOWN FOR ONLY \$1 (plus shipping and handling) and 50 FREE BOOKPLATES after your application for membership is accepted. We reserve the right to reject any application. However, once accepted as a member, you may examine the books in your home and, if not completely satisfied, return them within 10 days at Club expense. Your membership will be cancelled and you'll owe nothing. The FREE BOOKPLATES will be yours to keep whether or not you remain a member. About every 4 weeks (14 times a year), we'll send you the Club's bulletin, *Things to Come*, describing the 2 coming Selections and a variety of Alternate choices. In addition, up to 4 times a year you may receive offers of special Selections, always at low Club prices. If you want the 2 Selections, you need do nothing; they'll be shipped automatically. If you don't want a Selection, prefer an Alternate, or no book at all,

just fill out the convenient form always provided and return it to us by the date specified. We allow you at least 10 days for making your decision. If you do not receive the form in time to respond within 10 days, and receive an unwanted Selection, you may return it at our expense. As a member you need buy only 4 books at regular low Club prices during the coming year. You may resign any time thereafter or continue to enjoy Club benefits for as long as you wish. One of the 2 Selections each month is only \$4.98. Other Selections are higher, but always much less than hardcover publishers' editions—UP TO 65% OFF. The Club offers more than 400 books to choose from. A shipping and handling charge is added to all shipments. Send no money now. Just mail the coupon today!

Note: Prices shown are publishers' edition prices. \*Explicit scenes and/or language may be offensive to some.

# Good stuff, for a spell

## Magic focusing: a new dimension for possessions

by John M. Maxstadt

It is late Saturday night, and all the players have gone home. The brilliantly creative Scenario Designer and the eminently practical Dungeon Master (who, in this case, happen to be the same person) remain behind to work out a thorny problem in the campaign.

"I'd like to put in a magic item for the magic-user," begins the Designer.

"High time, I'd say," replies the DM. "The rest of the party has plenty of stuff, and he's got almost nothing."

"Magic-users are hard to shop for. He didn't like that *dagger +2* I got him last time."

"Well, he's 6th level now — he doesn't melee much anymore. I think he's about had it with scrolls, too."

"Some potions . . . ?"

"Potions are party treasure and go to whoever needs them most at the time. Besides, it costs almost as much to have them identified as it costs to buy them outright."

"True. Besides, I wanted to make this a long-term character item. How about a *cloak of protection*?"

"He's already got *bracers* and a *ring*. You want him to have a better armor class than the fighters?"

"He's an elf — what about magic boots, or a *cloak of elvenkind*?"

"The thief'd get 'em. He's got more use for 'em."

"Right again. . . . Well, how about a wand?"

"Remember that *wand of fire* he had a while back? Everything that *moved*, he roasted. I thought the darn thing would never run out of charges."

"And when it did, it was just a pretty stick as far as a low-level magic-user is concerned. Why didn't he conserve the charges?"

"Well, he didn't know how many there were, and he didn't know whether he'd get a chance to recharge it, or when, or how. Also, he might have lost it to a thief or a disenchanter or something. With all those unknowns, he probably figured the best way to be sure he didn't lose any of the benefit of the item was to use it as much as he could. Hard to blame him."

"Sure — you don't expect a fighter to "conserve" his new *sword +3*, do you?"

"Exactly. A wand boosts a character's power up *very* high, but only for a short period of time. Then it's a stick. It's essentially a game-balance problem, and you can never depend on players to voluntarily

maintain game balance."

"What if we compromise the rules and give him a wand with less than 81 charges left?"

"That's less powerful, but it's even more disposable. I thought you wanted a long-term character item."

"Yeah, yeah. Something useful, but not too powerful. Hey, why don't we give him a *wand of wonder*?"

"Why don't we just give him a *cloak of poisonousness* and save him a lot of aggravation?"

"I see your point. Maybe we could design an item that could be used only once per day or so, like those special scrolls in the *DMG*."

"If it had charges, it'd still run out eventually."

"No charges, then."

"Well, that's okay for you, but it makes me look a bit arbitrary. I mean, here I am as DM telling a player when and how often his character can use his own magic item. I like to leave things like that up to player choice. Besides, I hate to think of him making a point of using the thing every day so as not to waste it."

"If we could only run an item off the characters' own spell-casting powers . . . let the charges be his own daily allotment of spells . . ."

"Hey, why not?" exclaims the DM. . . .

. . . And so, the magic-focusing item is born, and the world is never the same again.

### Single-function focusing items

Basically, a magic-focusing item allows a magic-user to cast a spell he has not memorized by "focusing" the spell potential of any memorized spell of the same level into the desired spell (*i.e.*, the spell that the item "focuses"). A *wand of fireball casting*, for example, would allow a magic-user to convert any memorized 3rd-level spell (say, *clairaudience*) into a *fireball* without spending 45 minutes poring over his spellbook. Once the *fireball* was cast, of course, the *clairaudience* spell would be lost and forgotten, and the character would have expended one of his 3rd-level spells for the day — just as if he had cast the *clairaudience* spell normally. This wand would have no power of its own (although it would radiate a faint dweomer if *detect magic* were cast on it). It would be powered entirely by the magic-user's own spell abilities and therefore would never run out of "charges."

Right at the outset, it is advisable to prevent misunderstandings by outlining some of the things a magic-focusing item will *not* do. It will not allow a magic-user to cast spells of a higher level than he is able to learn; for example, a magic-user would have to be 5th level or higher to use a *wand of fireball casting*.

It will not affect the range, area of effect, duration, or damage of a spell except in the special case of "magic-enhancing items" detailed below. Therefore, for example, a magic-focusing wand would be exempt from the usual rule that wands function at the 6th level of power — a 5th-level magic-user would cast a 5d6 *fireball* through the same *wand of fireball casting* that would allow a 12th-level magic-user to cast a 12d6 *fireball*.

A magic-focusing item will not "store up" magical energy from spells cast the day before or spells cast by other characters — it is not a *rod of absorption*. Also unlike that device, a magic-focusing item will not convert one kind of magic (clerical, druidical, etc.) to another.

In spite of all these limitations, and the main limitation of having no power of its own, a magic-focusing item can still be a useful and desirable possession for a magic-user character. A magic-user with a *wand of fireball casting* has a *fireball* spell ready whenever he wants it, as long as his 3rd-level spells hold out, and the same would be true of any other magic-focusing item. These items effectively increase the number of spells a magic-user has to choose from at any given moment — and the more such items he has, the greater the choice. With a *wand of fireball casting* and a *wand of lightning bolt casting*, a magic-user will be able to choose between these popular spells at a moment's notice (a handy thing in itself) and will also be free to memorize in their stead more esoteric and specialized spells like *gust of wind* and *water breathing* — spells which might not be needed at all on a given day, but which might also be needed desperately and without warning. Thus, when the gorgon breathes or the floodgates open and the water starts rushing in, the magic-focusing *wands* will have proven useful without even having been used.

The greater the variety of spells available to a magic-user at any given moment, the greater the variety of spells he will tend to cast over the course of an adventure. Many game situations cry out for the creative application of a particular, little-used spell,



Capture and bring to life the entire spectrum of comic book Heroes!

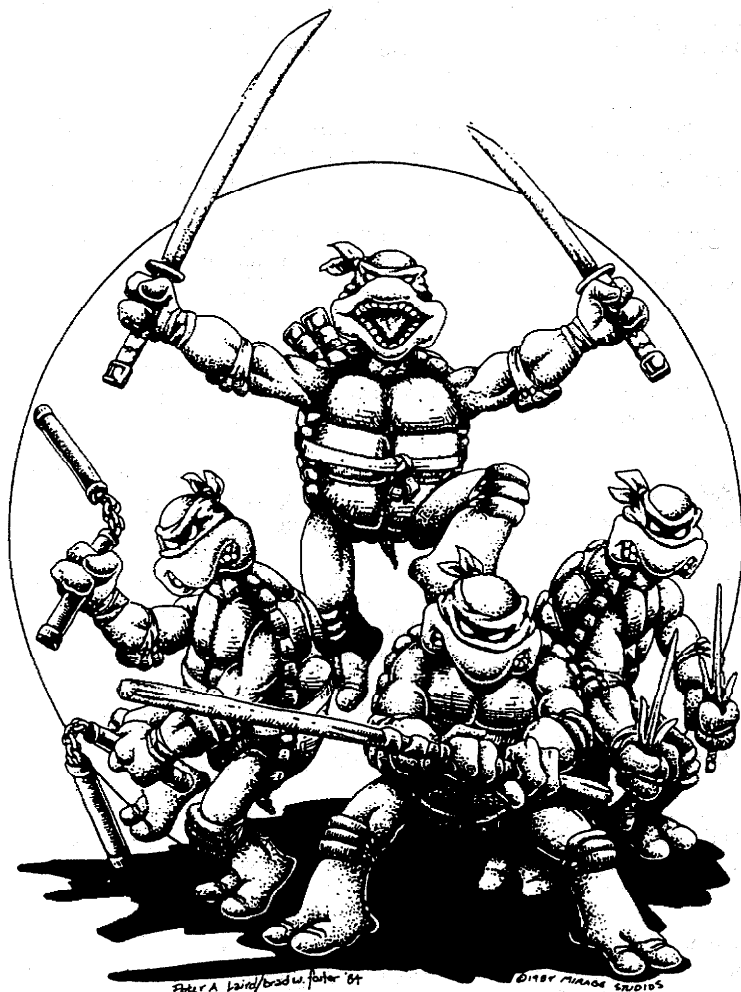

## Teenage Mutant Ninja Turtles & Other Strangeness

The possibilities for Teenage Mutant Ninja Turtles are endless. Whether you want to play straight comic book super heroics, post-holocaust mutants or frantic funny animals, it's all possible.

Now you too can transform ordinary house pets into the superheroes of tomorrow. From the family feline or hamster to lions, tigers and bears, you can create the most unusual superbeings in the annals of history.

Teenage Mutant Ninja Turtles & Other Strangeness loyally adapts the comic book with each character, from Raphael to Casey Jones, depicted complete with background and abilities.

### Highlights Include . . .

- A complete NEW game!
- Compatible with Heroes Unlimited® and the Mechanoids.
- Dozens of characters, villains and heroes.
- Several adventure scenarios and scenario ideas.
- An all NEW eight page Ninja Turtle comic strip by Eastman and Laird. Plus page after page of Eastman and Laird art throughout the entire book!
- \$9.95 (post paid)

## HEROES UNLIMITED®

Despite all the other superhero games on the market **Heroes Unlimited®** is still the only game that covers every aspect of the comic book hero. Only **Heroes Unlimited®** enables you to build/create a robot or cyborg, in addition to superspies, psionics, aliens and mutants. Comprehensive skills, education and back-ground, enable you to create three-dimensional characters that grow and develop. Guess-work superpowers are replaced by exact power descriptions. Combat is quick, clean and playable.

### Highlights Include . . .

- Steranko Cover
- Weapons and Equipment
- Robotics
- Bionics
- Psionics
- Spies
- Mutants
- Aliens
- Special Training
- Superpowers and Skills
- An Introductory Adventure Scenario and More!
- \$14.95 (post paid)

Palladium Books®  
5926 Lonyo  
Detroit, Michigan 48210

## After the Bomb!®

A post holocaust science fiction odyssey!

Four generations after World War III, after the nuclear winter, after the plague and after the collapse of humanity, intelligent mutant animals lay claim to much of the world. Join the animal civilizations, the Rodent Cartel, Wolf Barbarians, Bird Island, Gatorland, and the Gun Bunnies in their struggle against the Robot Warriors of the Empire of Humanity.

### Highlights Include . . .

- Animal Mutations.
- Robots and High Technology.
- Six Adventure Scenarios.
- Compatible with Heroes Unlimited®
- \$6.95 (post paid) — 48 Pages

A supplement for Teenage Mutant Ninja Turtles & Other Strangeness

## Teenage Mutant Ninja Turtles Adventures!

The adventures continue as our heroes travel to Japan to take on the White Ronin and his assassins in "Death Trials." Then back to New York to thwart the ever imbalanced Doctor Feral and his 'New' monstrous mutations. The Terror Bears reap mayhem in a game of nuclear roulette. The unstoppable Mr. Bionic and other adventures round out this Ninja Turtle game supplement.

### Highlights Include . . .

- A specially commissioned all NEW ten page Ninja Turtles comic strip by Eastman and Laird.
- The return of the *Terror Bears* and *Doc. Feral*.
- Five Adventure Scenarios.
- Compatible with Heroes Unlimited.®
- ALL artwork by Eastman & Laird!
- \$6.95 (post paid) — 48 Pages

Available in July!

but PC magic-users cannot generally predict these situations in advance when they are selecting and memorizing their spells for the day, nor can they expect the action to grind to a halt while they study their spellbooks. This is why most PC magic-users load up on major-destruction, "big blast" spells like *fireball*, *lightning bolt*, *magic missile*, and *cone of cold*, which are applicable to a large number of unpredictable situations but lack the more subtle, intellectual touch appropriate to the role of the wily mage. However, if the above spells were always on hand via magic-focusing items, many PC magic-users would experiment more with other spells that *might* be useful, as above; paradoxically, the guaranteed availability of the "big blast" spells might cause them to be cast less frequently. This could be considered a benefit to the Dungeon Master also, who might be getting tired of watching his magic-users blast their way out of every situation and who might appreciate a little innovation and clever spell-use from time to time.

A list of all the possible magic-focusing items and their individual characteristics would be far too long to be included here. This article is intended only to present the general idea of magic-focusing items; the details of the individual items will be up to the individual DMs and designers. I have generally confined myself to magic-focusing items through which one and only one spell may be cast. The forms I have used have been mostly wands (for directional and basically offensive spells), rings (for defensive spells and others that the caster is most likely to cast on himself or in his own area), and talismans or amulets (for short-range spells involving divination and enchantment). The spells I have used or most strongly considered using in designing these items are listed below.

Wands: *magic missile*, *knock*, *ray of enfeeblement*, *fireball*, *lightning bolt*, *ice storm*, *polymorph other*, *cone of cold*, *feeblemind*, *teleport* (target must be touched), *disintegrate*, *vanish*, *meteor swarm*.

Rings: *feather fall*, *shield*, *spider climb*, *invisibility levitate*, *blink*, *fly water breathing*, *dimension door*, *fire shield*, *airy water*.

Talismans or amulets: *charm person*, *detect magic*, *detect evil*, *ESP*, *forget*, *scare*, *suggestion*, *charm monster*, *fear*, *repulsion*, *mass charm*.

Other spells could be added to these lists, including some of the new spells in *Unearthed Arcana*. Other DMs may also wish to use other forms, such as boots, hats, musical instruments, etc. I have used wands, rings, and amulets because they are traditional (note that many of the spell functions above appear in conventional magical wands, rings, and talismans and amulets) and because it is relatively easy for a character to carry and use several of each.

This is *not* an invitation for DMs to indiscriminately shower their magic-users

with all the focusing items they can carry — focusing items may be less valuable than most other magic items, but they are more valuable than *that*. However, since these items allow a magic-user only greater variety in his choice of spells, and not more spells or more spell power, I might allow a mid- to high-level magic-user to accumulate three or four or more of each over the course of a campaign. I exempt magic-focusing rings from the usual rule of "one per hand," and allow as many to function as the character can reasonably and comfortably wear, since many of the ring spells are geared to emergency use (*feather fall*, etc.) and are not very useful if the magic-user must fumble for the correct ring. On the other hand, I also stipulate that spells cast through focusing rings must be cast by and on the wearer of the ring (*i.e.*, the magic-user himself), which does limit their use somewhat.

A few issues in the definition of magic-focusing items — what they can and cannot do — are so controvertible that they should probably be decided separately by each DM, with the demands of his own campaign in mind. One of these is the question of whether a magic-focusing item can convert one level of a spell into another, given equal total spell power. For example, could a *wand of fireball casting* combine three *magic missile* spells into one *fireball*, or vice versa? Could a *wand of magic missile casting* split one *fireball* spell into three *magic missile* spells? There is the precedent of the *rod of absorption*, but it does not apply well because many other powers of that device are specifically denied to magic-focusing items and because analogies between magic-focusing items and conventional magic items are tenuous at best and must be drawn with great care to preserve the general point that they are basically different animals. *Rary's mnemonic enhancer* is a better precedent because it involves actual spell-casting, but it is important to note the costly material components of this spell and the net loss in spell power involved (included, apparently, to discourage frequent use of the spell). Some DMs may find this kind of power conversion (with or without penalty) logical, others not; including this feature would make magic-focusing items considerably more powerful and desirable, which again might or might not be appropriate to any given campaign. In any case, it must be reiterated that magic-focusing items will *not* allow a magic-user to cast a spell of higher level than he is able to learn, and they will not convert different kinds of spell energy (magical, clerical, etc.) from one to the other.

There is also the question of whether a magic-focusing item will enable a magic-user to cast a spell, of appropriate type and level, that he has never learned, including even spells he is *unable* to learn due to an unlucky roll of the dice (see *Players Handbook*, page 10). If a magic-user does not have *fireball* in his spellbook, but can cast 3rd-level spells, can he use a *wand of fire-*

*ball casting* or not? The logic of the case depends on how much one assumes the magic-focusing item aids the magic-user in casting the spell — does it "know" the spell itself, or merely jog the magic-user's memory? Allowing this option would make magic-focusing items more useful and desirable (though not as much so as using the previously described option), and would tend to deemphasize the importance of spell acquisition in a campaign or draw some of the sting from it in a campaign in which it is strongly emphasized, if magic-focusing items became common enough.

Again, different DMs might view either of these effects as either good or bad. This option also allows the DM to make sure that a given spell will be available to the party at a crucial point in the adventure — a *knock* spell, for example, when the party is about to enter a dungeon level full of locked doors. Traditionally, this is accomplished by leaving the appropriate scroll lying around; leaving the appropriate magic-focusing item lying around instead removes the risk that the magic-user will blow the aforementioned dice roll, or simply copy the spell into his spellbook and then forget all about it. Since the item would not "teach" the magic-user the spell, no matter how many times he used it, he would be able to cast that spell only by using the item. This might lead to some interesting situations; it would also allow the DM to remove a spell from the campaign simply by removing the item, via a thief, disenchanter, *fire trap*, or the like (an especially useful trick in the case of DM-invented or PC-invented spells which later turn out to be too powerful).

Another set of issues concerns the effects of magic-focusing items on the manner of casting spells — the casting time, components, concentration required, etc. For example, it may not seem logical to require material components for spells cast through a device. If material components are to be eliminated, the spells should be restricted to those without elaborate or expensive material components (as in the lists above), unless a special provision has been made for including them (as with the *bag of conjuring focus* below), for game balance reasons. There is no logical need to eliminate or alter verbal components, but it might be reasonable to reduce the somatic components to simply pointing or waving a wand, touching or twisting a ring, or presenting or clutching a talisman or amulet, etc. If the DM decides that this should shorten the casting time, spells with long casting times should be avoided, again as in the list above, and again for game balance reasons. Also, discharging spell-like powers from conventional magic items requires considerably less concentration than casting spells in the usual way. While analogies between conventional magic items and magic-focusing items must always be drawn with great care, the logic of this limited parallel may still appeal to some DMs. Allowing magic-users to cast spells through magic-focusing items while arrows whistle past their ears



# Have you switched yet to the #1 role-playing system?

That's right . . . **RuneQuest** was voted "best role-playing system" at Games Day 5, Great Britain's version of ORIGINS! And that was even before the new modules were available! Think of how much fun you can have playing **RuneQuest** NOW.



We are committed to supporting this tremendously enjoyable role-playing system. By the time you read this message, we'll have even more modules and supplements for you. It's growing rapidly into the #1 system all over the world. Spending an evening in, says Bangkok, without knowing how to play **RuneQuest** could be embarrassing (not to mention boring).

## Latest Module!



For quick credit card purchasing call **TOLL FREE** 800-638-9292



## The Avalon Hill Game Company

DIVISION OF MONARCH AVALON, INC.  
4517 Harford Road ★ Baltimore, MD 21214

## Here's what's in the complete **RuneQuest** system to date:

- **Deluxe RuneQuest**—the complete game with 3 magic systems, new skills, new spells, and new combat rules . . . **\$38**
- **Monster Coliseum**—arena combat and chariot racing of the early Roman era . . . **\$16**
- **Human Adventurer**—not a game, but a playing-aid supplement for scorekeeping . . . **\$10**
- **Nonhuman Adventurer**—includes scoresheets for 16 of the most imaginatively unique characters possible . . . **\$10**
- **Vikings**—the gods, giants and monsters from viking legend; a fascinating blend of history and myth . . . **\$24**
- **Gods of Glorantha**—introducing hundreds of new skills, spells and sorcery in this gloranthan supplement . . . **\$18**
- **Griffin Island**—includes brand new map, and devices freeing the gamemaster to join in the play himself . . . **\$16**

Available at your favorite game store, or direct from:

would add another considerable advantage to using these items.

The DM will also have to determine the experience and sale values of magic-focusing items. It is suggested that the sale value be relatively low — say, 1,000 gp per level of spell focused — to encourage PCs to keep these items and use them. However, the experience-point value could be proportionately higher, even as high as the sale value itself. If the sale value is kept low, the DM will have to take steps to prevent PCs from buying large numbers of focusing items with ready cash. The easiest way to do this is to make them very rare or even entirely absent from the open market, generally introducing them only as “found” items. The DM may opt to assume that magic-focusing items are the occasional, accidental by-products of failed attempts to create “real” magic items, and that the mages who create them are generally too disappointed over their apparent failure to concern themselves with what their faulty creations can do. This would explain their low sale value and their general absence from the open market, and it would also help explain how such things came to be lying around a dungeon or in the hands of monsters.

### Special cases

Until now, we have considered only items through which one and only one spell may be cast. On occasion, the DM or designer may want to design an item that would focus several related spells. For example, a *wand of fire focus* could convert spells of appropriate levels into *burning hands*, *pyrotechnics*, *fireball*, *fire charm*, *fire shield*, *wall of fire*, and *meteor storm*. Such an item would take the place of several single-function focusing items, and so would be rarer and much more valuable. A character should probably acquire no more than one or possibly two of these devices even in a very long career of adventuring (it is always important to place focusing items with care — since they do not wear out or become used up, they tend to become permanent fixtures in a campaign).

Multi-function focusing items should work much like the single-function kind, as detailed above, and they carry the same basic advantages for the character and for the DM. Multi-function focusing items have an additional benefit for character development, in that they encourage magic-users to specialize in a certain kind of spells (fire spells, alteration spells, artificial-motion spells like *levitate*, *fly*, *telekinesis*, *teleport*, etc.), which gives the character more of an individual style.

Another way to add color to multi-function focusing items is to give them a greater variety of forms (staves and other personal objects, articles of clothing, musical instruments, etc.), since there would be no need to make it convenient to carry and use large numbers of them. Thus, *spectacles of visual spell focus* could focus *clairvoyance*, *infravision*, *wizard eye*, and all the

*detect* spells (a magic mirror or crystal ball would also be an appropriate form here). A *glove of Bigby's hand focus* could focus all the *Bigby's hand* spells, and a *bag of conjuring focus* could focus *unseen servant*, all the *monster summoning* spells, *conjure elemental*, and *Drawmij's instant summons*. The latter item would work like a *bag of tricks* the material components for the last two spells would have to be inserted into the bag prior to casting the spells, for game-balance reasons, and there might still be some game-balance difficulty with adjusting the casting time for a *conjure elemental* spell.

Another advantage of the multi-faceted focusing item is that the character is less likely to “outgrow” it. A flute that focuses sleep is a fine item for a 1st-level magic-user, but it would probably be sold off around 3rd or 4th level. However, if different tunes on the same flute would also focus *confusion*, *fear*, and *Otto's irresistible dance*, the item should remain highly useful throughout the character's career.

A second variation on the basic single-function magic-focusing item would be the magic-enhancing item. Such an item would focus one and only one spell, but it would also improve the spell in some way — increase the range or the duration, heighten the damage, etc. Many forms of “enhancement” come to mind, but the simplest would be to have the item allow the spell-caster to cast the spell as if he or she were one or more levels higher in the profession, so that a 5th-level magic-user could use a *wand of fireball casting +1* to cast 6d6 *fireballs* at a range of 16”, a 6th-level magic-user 7d6 *fireballs* at 17”, and so on. This item would be closely analogous to a *fighter's sword +1*. It should be noted that an enhancing item would *not* allow a magic-user to cast a spell of a higher level than he is able to learn, but merely to cast spells of appropriate levels more powerfully. In some cases (such as *charm person* or *invisibility*), enhancement in terms of spell-caster levels will have no effect, so such spells should be avoided or handled differently in enhancing items. Like multi-function focusing items, enhancing items should be much more valuable and much rarer than ordinary focusing items, and they should likewise be placed with great care because they tend to become a permanent part of the campaign.

### What about other classes?

It may seem strange that, up to this point, this article has considered focusing items only for magic-users and not for the other spell-casting classes. The fact is that I have only made use of the concept for magic-user items in my campaigns. Few of my players have run illusionists as it happens, and as for clerics and druids — well, magic-focusing items for them have their own special problems.

Magic-focusing items for clerics and druids would tend to usurp part of the deities' role. Deities decide, in person or through intermediaries, which spells their

respective clerics may memorize on a given day. A highly chaotic deity who objects to the use of *command* or a warrior-deity who considers spells such as *sanctuary* and *feign death* “sissified” would not be happy to learn of magic items that would allow his clerics to subvert his wishes in these matters. Since such items would be useful primarily to circumvent the deities' authority (at least, the deities would tend to see it that way), and since clerical magic items are created only through the aid of the deities, it seems highly unlikely that such items would exist.

If the DM takes his role as deity seriously, and plays it carefully with regard to the granting of clerical spells, the need for clerical focusing items can be obviated. The player may not know what situations the day's adventuring may have in store, but the DM (and therefore the deity) should. The DM-as-deity can therefore adjust the cleric's daily spells according to what he is most likely to need. This could take the form of gentle hints from the deity or intermediary, or it could be imposed on the cleric perforce, although much coercion should not be necessary if the cleric character is being role-played with a fitting sense of the importance of his deity's opinions. If an emergency situation occurs that no one (including the DM) could have foreseen, and the cleric legitimately needs to change a spell post-haste, I think it not unreasonable for a deity to grant a hasty prayer to that effect, from a cleric in good standing.

If for some reason the DM still wants to give the cleric a focusing item (perhaps a “shopping” problem, as alluded to at the beginning of this article), such an item would probably take the form of a special holy symbol, icon, relic (though not in the “artifacts and relics” sense), censer, prayer wheel, etc., and should be created and closely monitored by the deity. The best spells to focus would probably be “bread and butter” spells such as the various *cure* spells. Even then, the use of such an item by an evil cleric would have to be *very* closely monitored. The DM may decide that the cleric's deity can cause such an item to cease functioning at will.

If druids are ruled to have personal deities, rather than simply worshiping nature as an entity, they will have the same problems with focusing items as clerics, above. If not, druidical focusing items could be very interesting and very useful to the character. Druidical spells are generally cast very close to nature, and the most distinctive ones usually require a natural setting; *animal friendship* requires the presence of a wild animal, *entangle* requires undergrowth, etc. Focusing items might not only enable a druid to choose from such spells at will, but to cast them inside caverns, dungeons, etc. For example, a length of green vine or ivy or a rope woven from willow shoots might allow a druid to focus *entangle*, and to use the item itself in the place of undergrowth, indoors. Such an item would certainly make the druid more effective in indoor and



underground adventures. DMs may have differing opinions on how this would affect game balance, depending on how they view the relative strength or weakness of druid characters without such advantages. As always, it is important to remember that it is easier to introduce a focusing item into the campaign than to remove one.

Focusing items for illusionists would have all the advantages of magic-user items. There is the aesthetic objection to the creation of complicated illusions with the mere wave of a wand or the touch of a ring, all the more so since illusionist spells are supposed to have elaborate somatic components. There is also the more serious problem of what it does to the deception to have the illusionist wave a wand or other obvious magical item in the direction the illusion is about to appear. (I have played a character who had just this problem with a conventional *wand of illusion*.) Of course, spells that illusionists share with magic-users which are listed on the table above could be focused through wands, rings, talismans, or amulets also (though not the same wands, rings, etc.), and some other defensive and personal spells, such as *change self*, *gaze reflection*, and *blur*, could also be focused through rings. Forms for

focusing more elaborate illusionist spells might include silk foulards (for *misdirection* or the various versions of *invisibility*), or paint brushes for making detailed illusions that no one will see until after the illusionist has finished them (such as *hallucinatory terrain*, *massmorph*, and *programmed illusion*). Such paint brushes would not logically have to shorten casting time, and could in fact *lengthen* it for the last two spells. The shortcomings of brushes as focusing items for on-the-spot illusions such as *shadow magic* and *shadow door* are obvious.

A week later, just after the most recent playing session, the Designer and the DM take time to pat each other on the back:

"Well, how did it go?" asks the Designer, knowing what the answer will be.

"You would have thought I — excuse me, you — invented the wheel. I haven't seen that magic-user so happy and self-satisfied since the day he toasted his first orc!"

"Such a simple concept, but with so many potential applications. . . . It almost makes me wonder why I didn't think of it sooner."

"Yeah, that's probably what the guy who invented the wheel said, too. . . ." S

## ILLUMINATI™

### The Fast, Exciting, New PBM Game Of Intrigue And Strategic Conflict

Now you can become the absolute master of one of Earth's most powerful secret organizations. Your agents eagerly await your orders. Your mission is nothing less than **Total World Domination!**

#### JOIN THE PBM CONSPIRACY

- ▲ Twenty-four players per game
- ▲ Full diplomacy — make and break alliances
- ▲ Send messages through the computer
- ▲ Every player's position is different
- ▲ Every player has a unique secret power
- ▲ Clear rules with excellent examples
- ▲ Simple, easy-to-complete turnsheet
- ▲ Detailed reports on all results, in English
- ▲ No turn deadline, no missed turns
- ▲ 24-hour turnaround guaranteed
- ▲ Completely computer-moderated
- ▲ Professional management
- ▲ Over 20,000 turns processed
- ▲ \$7 (U.S.) for setup, rulebook, and 2 free turns
- ▲ Only \$4 (U.S.) per turn — never an extra charge

"Great rules. great action. just an incredibly great game!" —Jeff Ferris

"HIGHLY RECOMMENDED!" —Gaming Universal



For information, write to:

**Adventure Systems**  
P.O. Box 22305-X  
Houston, TX 77227

ILLUMINATI and the all-seeing pyramid are registered trademarks of Steve Jackson Games Incorporated. ILLUMINATI THE PLAY BY MAIL CONSPIRACY is a licensed version of S J Games' ILLUMINATI board game. All rights reserved. Fnord.

## THE LEXICON

Atlas of the Lost World of Atlantis  
Fantasy Role Playing Game Supplement



# The Lexicon

Discover the lost cities and lands of the legendary Second Age of Atlantis in THE LEXICON, cyclopedia and atlas of the Atlantean world. Travel to Avalon, home of the Half-elven survivors of First Age Atlantis. . . to the land of Hyperboria, where armies of Dwarves and Trolls vie for control of the ore-rich Rhiphaen Mountains. . . to the jungle continent of Mu, where the avian Zephyr dwell. . . explore Tartessos, the infamous "City of Sin," or join in the battle with the Amazons of Hesperia. Useable with any FRP game system, THE LEXICON contains a fold-out map of the world, 10 full-page regional maps, 5 cities (with annotated maps), and detailed descriptions of all the lands of the Antideluvian Age. \$14.00

Also available from Bard Games: **The Compleat Fantasy Series, The Bestiary, The Arcanum.**

Available at Waldenbooks, B. Dalton Books, and finer hobby stores in the U.S., Canada, and Australia.

**Bard Games**  
where fantasy becomes reality

# Welcome to Malachi

## Visit a city where magic reigns supreme

by Becky Helfenstein

---

“So, it’s off to Malachi with you, is it? Are you sure a bunch of provincial bumpkins such as yourselves are ready for the wonders of the big city?”

The weathered caravan master chuckled to himself and continued. “Another pack of farmer’s sons and daughters tired of the fields and fighting kobolds, anxious to greet the lights and luxuries of the King’s own demesnes. Do you know just what you’re getting into? Sure, and the stories are true. Wonders the like of which your little village has never dreamed. Exotic specimens from the four corners of the world! Splendid palaces of pleasure to delight the senses in unimagined ways! Healthy, well-fed people. Gems, slaves, mansions, and respect for any brave or rich enough to buy them. Aye, you’ll have a good time in Malachi. But remember, my young gadabouts: Every city has its dark side, too. . . .”

What city is this caravan master talking about? Certainly not a medieval, middle European town. He makes no mention of the disease, filth, and poverty of teeming masses packed between heavily fortified walls, without the benefit of modern technology. On the contrary, he’s discussing Malachi — a major city on the northwestern coast of the continent of Urth, the setting for a city adventure in an AD&D® game.

DRAGON® Magazine has recently presented articles informing its readership of the true status of medieval cities, for use as a basis for designing their own city adventures. While including such factors as leprosy, plague, food and water shortages, fire hazards from home lighting, and corrupt legal systems may add historical realism to a campaign, they do little to reflect the possibilities of a magical universe. On Urth, the laws of magic were discovered early in its history; technology, where it’s discussed at all, is regarded as a superstitious, unenlightened pipe dream — something possible on another plane, perhaps, but certainly nothing the citizens of Malachi would care to live with.

Malachi is a major population center on a relatively young world. Humanity is the predominant species on Urth, but only by a small margin. The various species of demihumans and the legions of monsterdom make the human margin of control slim indeed. Only a small percentage of the population of Urth is of adventuring caliber, and that number faces constant attrition in

the course of daily life. Everyone on Urth knows the veracity of the saying, “There are no old adventurers.” However, the percentage of adventurers or semi-retired adventurers is higher per capita in Malachi than in less civilized places on Urth. The reason, besides the obvious comfort and convenience factors, is that it is an ideal place for a talented individual to make a living without risking his or her neck for every gold piece. Let’s take the character classes in order to demonstrate their contribution to “the good life” in Malachi.

### The power of the churches

Clerics are the true backbone of life in Malachi. The church exerts its influence in nearly every phase of the citizen’s life, from infant dedication to the gods, to funeral rites and burial (if the body is available). The missions offer healing to the poor, and all diseased are ordered to the church for curing upon discovery of an affliction. While *resurrection*, *raise dead*, and *regeneration* are reserved for the wealthy who are able to pay the high fees commanded for these services, a man’s family may be required to serve in the church for only a year to pay for his *blindness* cure. The church which is directly in service to the king provides disease control for the city, sending hardy, if low-level, adventurers to dispatch rat hordes, while isolating plague victims within the church until *cure disease* can be used. Free medical care is readily available to the poor, and those who can afford to tithe to their church are assured of help from their local priest.

Medical services are only one aspect of the church’s influence, though. Merchants, for a reasonable fee, can have their spoiled or fouled foodstuffs purified at the neighborhood temple. Unruly acolytes are often put on “purification detail” to contemplate the foulness of their own misbehavior. Some sects maintain a booth in the marketplace for magic detection, both to serve lazy adventurers and to validate the truth of a merchant’s claim. *Continual light* devices are a popular, if expensive, item sold throughout the city. All major streets have *continual light* street lamps, and most middle class homes have at least one “light ball” carved from wood and easily transportable from one room to another. The king has contracts with all good and neutral churches concerning serious food and water shortages, and the missions dedicated to the poor have “manna lines” in which created

food is doled out to those who would otherwise go hungry.

Malachi’s legal system is heavily dependent on the church. Nike’s temple is the seat of justice in Malachi, with her lawful neutral clerics scrupulous in their decisions. Any citizen accused of a crime is brought before a court of clerics who question the defendant under a *detect lie* spell, subject him or her to *know alignment* and *detect charm*, perform *auguries* to ascertain the validity of the judgment, and (in the case of important murders) speak with the dead victim for identification of the criminal. Any sentenced to death are properly magicked to make *resurrection* difficult. These are but a few of the mundane uses of a cleric’s talents. Special circumstances and heavy purses of gold allow access to the more esoteric abilities of the godly, and generate many possibilities for role-playing.

### A druidic park service

Druids are *not* useless, as is commonly claimed, in a city adventure. In Malachi, a small city park is maintained by an order of druids. This tract of land was a concession to the druids of the area by the original founder. An enslaved earth elemental patrols the grounds, often assisting with *distance distortion* spells from a neutral mage, so the park has the peculiar appearance of being bigger on the inside than the outside. Citizens are free to visit the park as long as they respect the sanctity of the druids and the park’s inhabitants. Wise visitors stay on the paths and don’t stray into the gardens proper. Player-character druids are welcome to seek solace and advice in the park, but woe to the hapless party member who tampers with any of the sylvan denizens.

The current king continues a working relationship with the druidical order, receiving weather forecasts and advice on planting and harvesting. The order has agreed to help out in the event of a serious water shortage, and some members also conduct healing clinics as well as selling poison antidotes to merchants. One nature lover has set up a small veterinary office to care for sick animals. The more artistic druids have been known to work wonders in stone for the town’s upper class.

The relationship isn’t always smooth, though. The druidical orders follow the Celtic mythos, while the city’s churches follow the Grecian gods. There is constant rivalry between these two groups with little friendly interaction. So far, no evil Greek



temple has advanced a cleric to twelfth level, but the druids are ready to call the Wild Hunt as soon as a priest achieves the title. Needless to say, the king and the churches themselves are striving to prevent this from happening, as the Hunt would critically damage Malachi. Unfortunately, evil priests are less than cooperative when it comes to giving out information concerning their membership. The druids honor their agreement with Malachi, but would not be unhappy to see this jewel of civilization ruined in order to restore the balance of good and evil.

### The fighting arm of Malachi

Fighters find work more easily than any other class. King's guards or mercenaries, bodyguards or night watchmen — fighters and their subclasses are readily apparent. Merchant ships hire elite pirate and sea-monster fighters, bars need bouncers, mages need human shields, and slavers and press gangs are always looking for strong backs and weak minds. The fighting classes contribute to the luxuriance of Malachi. Since they usually have money they are eager to spend, they often commission custom-made swords and armor, and they form the city's bottom-line fighting strength.

Enterprising fighters conduct training sessions for the warriors' guild, and the less scrupulous offer their muscle to the thieves' guild. When picking locks fails on a mission, bending bars skill may come in handy. Some form collection agencies for local moneylenders. (Try telling a 4th-level half-ogre fighter that you'll have the money for a gambling debt next week!) Warehouse and other heavy work is always available, though admittedly it doesn't pay as well as the more glamorous positions. Pest control companies are often run by low-level fighters taking their chances with rats and insects within the relative safety of the city. For example, there's Sam, a semi-retired half-orc fighter, who runs Sam's Sausages, a place popular with some of the city's non-human population. There are those who cast suspicion on the ingredients he uses and refuse to enter his store, fearing they may become part of next week's special. For a fighter, looking for work in the city can be an adventure in-itself.

### The world of magic

Magic-users are perhaps the class most responsible for the comforts and luxuries of Malachi. Studious types can make a very comfortable and relatively safe living performing various divination spells. Even a lowly prestidigitator can live comfortably casting *identify* and *read magic* for active adventurers. Of course, part of each fee goes for insurance with the local church in case of curses or other malevolent effects. Harried, affluent mothers are often willing to pay for a *sleep* spell to quiet a cranky baby, and *enlarge* spells and *Nystul's magic aura* have their customers. Many will cast *mending* spells for a modest fee, and one

mid-level mage supports himself quite well running a message service. Madge the Mage, manager of the Hylas Hotel, uses her *unseen servants* as chambermaids, along with other spells that make her job easier and her customers' visits more comfortable.

The more commercially oriented mages also sell *continual light* devices, *invisibility* spells, and bestow exceptional strength on those who are in temporary need of it. *Magic mouths* are in great demand for everything from burglar alarms to advertising to practical jokes. *Levitate* spells are often purchased by construction companies, and pyrotechnic displays are all the rage at fancy celebrations. A few mages operate private investigation offices which employ *clairvoyance*, *clairaudience*, and other spells to gather information for clients. These agencies are against the law, as the king insists on his own privacy, but their existence is hard to detect and prove.

Higher-level mages are not all averse to supporting a lavish lifestyle by selling their talents. Besides doing research for those who are untalented or unable to spare the time, they are also responsible for building and designing some of the more impressive mansions in town. One mage specializes in alarms and traps for wealthy citizens. Many are paid a retainer by the king in exchange for their services in times of trouble. Fewships set sail without a resident mage.

One ordinary merchant makes his living because of the gratitude of a high-level wizard. It seems he helped the fledgling apprentice out of a jam, and was promised a reward when the mage came into power. He now has specially constructed wooden molds manufactured which he fills with water. Once a week, the wizard visits his warehouse and casts a *cone of cold* on the molds. The merchant can support his family very well as an ice dealer.

Illusionists play an important part in the life of the city, too. For the timid and untalented, an illusionist's "picture parlor" offers *spectral force* shows which are every bit as exciting as real adventuring, but much safer. These showmen occasionally pay active adventurers for vivid descriptions of their travels which the illusionist can incorporate in his next "picture." One famous pleasure palace has a permanent illusion of a young lovely disrobing below its sign, an advertising device that has embarrassed more than one naive tourist. Cruel masters sometimes feel the expense is worth the gain, and will pay to have *dispel exhaustion* cast on a tired or overworked slave. Illusionists are often employed by the very rich for an evening's entertainment at parties.

These examples only touch on the ways that magic has replaced technology in Malachi, but should serve to inspire the imaginative DM with many "luxury" gold drains for too-affluent adventurers. Magical amenities and other status symbols are a wonderful way to remove excess monies from player characters, leaving them with

something to brag about without increasing their combat abilities. One of the half-ogres currently adventuring in Malachi is saving his hard-earned gold to purchase a mansion full of slaves in the old section of town. He wants to buy his way into society (unlikely to happen, but he'll spend many a platinum piece finding out the hard way). This is much less destructive to game balance than saving for an intelligent *sword* +5, and has been this character's goal since he first set eyes on Malachi. His best friend, another half-ogre, is saving up to have a size extra-large suit of banded armor enchanted. He knows it will cost a dragon's hoard in gold, but figures it's easier than finding an ogre wearing *chainmail* +2.

### The shady side of town

Thieves have an obvious place in the city and need little discussion here. It's worth mentioning, though, that some of the more ethical thieves operate locksmith shops. Others are also involved in detective work, theirs looked on with more favor by the government because they don't use the illegal advantage of magic to gather information. Ffredd's Burglar Alarm Company (founded on the theory that it takes one to catch one) offers home-protection devices at a much more reasonable rate than Merton's Mystic Anti-Intruder Incantations.

All thieves, regardless of their source of income, are required to register with the guild. The first problem is finding the guild. It's rumored that the initial step is to take some "warm" goods to the pawnshop to be fenced. Finding the right pawnshop is the second problem.

The very word "assassin" is enough to strike terror in the prominent citizen's heart, as assassination is a thriving business in Malachi. There are business rivalries, religious differences, bitter feuds, and jealous lovers. The best alarms, the toughest bodyguards, and the most ironclad life assurance policy with the clergy are not hindrances to the truly competent assassin. It's an extremely effective tactic, warning even those lucky enough to be raised that someone is out to get them or unhappy with their business practices. The assassins' guild is also the primary source of poison in Malachi. It doesn't have a shingle advertising its presence, but it sells well-enough.

### The "other" classes

Monks maintain monasteries within Malachi's walls, too. Their orders are patterned after those suggested by Philip Meyers in Best of DRAGON Magazine Vol. III, divided into lawful good, lawful neutral, and lawful evil factions. The sight of a monk with her alms bowl in the street is a common one, and the townspeople are generally supportive of them. While monks do not sell their services, the good and neutral brothers help maintain law and order. Groups of them form patrols which walk the streets at night to prevent crimes.

Bards hold a special place of honor in Malachi. They are street entertainers,

advertisers, poets, storytellers, historians, newsmen, and singers. There are bards who own agencies which charge specific amounts for specific services and bards who work strictly for donations. Very rich and socially conscious citizens act as patrons of the arts, and are rewarded for their generosity with epic, heroic songs or poems concerning noble lineages and wondrous exploits. If the DM has any secret poetic talent, these expensive tributes to a player character's courage are another great way to take back gold pieces. Bards who prefer an easy living often work for the wealthy caring for children or animals. Bars offer another easy living for the musically inclined, and their abilities are uniquely suited to calming a rowdy clientele.

The rare psionically endowed individual has special problems in Malachi. Those who register with the city as sensitives are monitored, but allowed to charge for legitimate uses of their abilities. A few are in the employ of the government and military, used primarily to detect unregistered psychics. One gambling casino is rumored to keep several psychics on the payroll, although officials have yet to catch one tampering with the games. The penalties for unlicensed or unethical use of psionic powers are stiff, generally including a fine and imprisonment, and on rare occasion calling for the death penalty. Most of the citizens don't trust mental powers and prefer to use the services of more reputable spell-casters, so the few who do have psionics generally limit their use while in the city.

### Curious businesses

Aside from these examples of business in a fantasy city, there are operations where the use of magic is suspected but not yet proven. Bealse, the statue seller, is a case in point. Some of his creations are so lifelike they seem to have been breathing a short time before. Rumor has it that some of the stone lions adorning mansion steps were once living beasts, caught by a *flesh to stone* spell. One adventurer reported selling the gleanings from a gorgon's lair to Bealse for a fair price, but one hears many tales over a cup of ale.

"The Frog and Mermaid" is another source of speculation. A special menu is offered for overweight patrons, offering all the delectable selections from the regular menu — with a claim that no weight will be gained from eating the food. Satisfied diners report leaving full and contented, but skeptics complain they were charged for an empty plate and a realistic illusion.

Many other businesses thrive not because they are magical in nature but simply because magic exists. Component dealers needn't have the talent themselves to roll bat guano and sulfur balls. Exotica emporiums buy and sell everything from monster eggs to baby dragons to landshark-foot sword stands. It's not difficult to convince characters that their lives aren't complete without a winter-wolf bedspread. What's money for but to spend, anyway? That

vodyanoi-skin sword sheath may not work any better than a leather one, but there's so much more prestige to its appearance. Enterprising characters may even take to butchering their more exotic kills for their sale value. The scenario possibilities here are unlimited. "Wanted: one mimic brain. Inquire within."

Malachi has a linguists' guild, where for a modest fee characters can gain those additional languages. Sages and alchemists are for hire, and membership in the common library is inexpensive considering the wealth of literature available. The city's booksellers are another place scholars haunt to find that bit of arcane knowledge needed to complete a private library. Money-changers have a guild and offices where coins are converted (for a percentage, naturally) to smaller and larger denominations, or to the coin of the realm.

Other scenarios suggest themselves from the basic city setup. Why has Ichabod the Iceman suddenly closed his business? What are the restaurateurs and food brokers who have grown dependent on his services going to do now? Clerics and other adventurers needed to exorcise a haunted house. Wizard needs live tunnel worm for experimentation; top price paid. Wealthy merchant seeks to hire housemage — must know *charm person*. "Did you hear about the poor Stormsinger family? The third member of the family just died of a mysterious disease. And they have that nice Brother Bilius living with them, too. It must be a terrible sickness to be not curable by him. Poor man. But I heard that they've included him in their wills out of gratitude for his services. Lady Stormsinger said he was so loyal he said he'd never be able to live with another family if anything happened to them."

### Malachi: background and growth

Malachi was initially designed to serve several functions. After three years of play, my world needed a place where adventurers could sell the valuable pelts and owlbear eggs collected on their travels. A system for removing excess treasure was becoming increasingly necessary, and the players wanted a change of pace from dungeons and wilderness. Lastly, it was designed to be a reward for player characters. How many hapless characters spend their entire lives sleeping on one cold cave floor after another? After all, isn't the main reason for risking your neck to enjoy the fruits of your labor? Nubile slaves peeling grapes for the weary warrior are a common component of fantasy. Constant adventuring makes even the stoutest character tired after a while, and it's nice to have a fun place to relax for a time. So what if sometimes that place gets as exciting as the rockiest mountain range — it's so much more pleasant to fall asleep in a featherbed in the city's finest hotel.

Malachi started as a wizard's castle on the mouth of a river. Within a decade, it had grown into a walled keep. Over the years, the city kept expanding, and existing

walls were torn down and rebuilt to accommodate the growing citizenry. The original keep walls are still in existence within the city walls, and this area is the most prestigious and expensive in the city. Old Town, site of the first expansion, is a mixed area containing both stately mansions and hovels where the peasants who serve the wealthy live. Religion Row was an addition to house the expanding clerical population, and holds nine temples representing each of the alignments (the evil ones are closely watched). This section of town is luxurious, expensive, and well maintained. Druids' Park is in this section, as are the guild houses. Newport and Riverside are the results of Malachi's latest growing pains and are the least expensive and most dangerous parts of town. There are four major marketplaces: one each in God's Row and Newport, and two in Old Town. Numerous wells, fed by the river, provide water and fields surrounding the city provide both food and work for the peasants.

The population consists of nobility, rich merchants, and wealthy adventurers forming the upper class; moderate merchants, service people, and farmland owners constituting the middle class; and, peasants, laborers, and servants making up the lower class. Slavery is legal in Malachi, and many of the rich have large stables of slaves. One can be forced into slavery as punishment for certain crimes, and traveling slavers consistently increase Malachi's population.

Even after a year of play, Malachi is far from finished. Approximately three-fourths of the city is detailed, some parts as sketchily as "Newport 138-147 — modest private homes" to fully detailed floor plans with every NPC rolled, named, and described. Several edifices are empty, under construction, or otherwise unremarkable. These are "Outs," in case it becomes apparent at some point that an important and necessary business has been entirely omitted or forgotten. Established businesses range from traditional armorers, fletchers, and blacksmiths to wand and scroll case shops, potion dealers, and insurance agencies. "Homer's Hospitality House" has a sign on the door proclaiming "Humans Only," while any creatures not possessing orc or ogre blood feel decidedly uncomfortable at "Filthy Flydung's Tavern."

Marketplaces have a periphery of stationary buildings surrounding a square filled with transient tents and stalls. Random charts govern which merchants have a tent or stall on any given day, and let the buyer beware when purchasing an expensive item from a roving merchant. Temporary stalls include everything from mundane supplies to fortune tellers (some legitimate, but the charlatans are hard to find again) to food vendors. The port assures a constant variety of people and merchandise, giving the city a sense of reality and a dynamic feeling. Transportation can be by foot, horseback, camelback, and elephantback (and once in awhile something even more unusual), and by carriage, sedan chair, broom, and magic

carpet. Straightforward liveries offer normal animals and conveyances, and specialists offer fledgling hippogriffs and subdued-dragon carts.

Special encounter charts provide for all the encounters listed on page 191 of the DMG, as well as poorly timed chamber pot emptyings, additional monsters from the **FIEND FOLIO®** Tome and *Monster Manual II*, overhead traffic, and street brawls. Panicked herds, unusual events, and common cats (or is that a luck eater?) all have a place in the scheme of things. The charts are modified by section, with undead and were-creatures more common by the graveyard, and slavers and pickpockets prevalent in Riverside. One group of inexperienced adventurers jumped every time they spotted a cat, crow, or frog, convinced every magic-user in town was scouting them with his or her familiar. Malachi serves as both a base for player characters to operate from and the setting for mini-adventures, some of which start as simply as a shopping trip for components.

Players with dreams of building their own fortresses in some abandoned stretch of wilderness may wonder at Malachi's attraction for so many spellcasters. The reasons are really the same that motivate any people to move to the big city. Malachi offers convenience, luxury, companionship, safety, and availability of supplies and knowledge. There are obvious cultural advantages to living in town. Henchmen are easier to recruit here, and advice and aid are available, for a small price, of course.

Jobs are easy to come by in the city, too. Not only are the aforementioned professions common, but there is a constant demand for trained adventurers in so large a place. A rich merchant may need bodyguards for his visit to the family castle, a day's ride from town. Farmers want protection from xvarts raiding the fields. In Malachi, jobs are constantly being advertised by poster, town crier, and rumor mills. PCs may find they're not tough enough for a particular duty, or that the positions have already been filled. These blind leads add another dimension of reality to the life of the city.

Malachi was never intended to accurately mirror a medieval town, nor was it meant to represent a modern metropolis. Malachi is a city of magic, in a magical universe. Probably its greatest inspirations were the Arabian cities of Ali Baba movies and Randall Garrett's "Lord Darcy" series. In the Darcy books, magic is commonplace and technology nonexistent. They are wonderful source material for magically sophisticated world designs. Robert Heinlein's *Magic, Inc.* is another example of a magical universe where spells replace science. Any PC worth his salt is constantly looking for more effective ways to use his or her magic and abilities. NPCs should be at least as inventive in their uses of magic. Poverty-ridden, plague-infested towns and cities exist on Urth, but only in areas controlled by evil or where there are serious shortages of trained spell-casters. Small villages and hamlets

more closely follow medieval patterns, but Malachi, by its very nature, represents something different.

The caravan master scratched his beard wistfully. *Pack of young fools, he thought to himself. Wonder how many will survive their first year in the big city? So many temptations, and so many hucksters anxious to help a fool and his coin part ways. Ah, well, it's an experience they'll never forget, even the ones who go running home with their tails between their legs in half a year. And some of them will make it, like as not, and be living in one of them fancy houses in time. That's one thing can be said for Malachi - it's a land of opportunity for the enterprising. Been a long time since I just relaxed. Maybe I'll stay awhile this trip, see the sights.* He smiled at the thought.

"Come on, you wet-eared puppies." The old man motioned to the eager group of novice adventurers. "I'll take you in and introduce you to Mama Rosa. She and her girls run a nice, clean, reasonable little boarding house in Old Town, and she serves the best breakfast in Malachi. She don't allow no drinking or wenching on the premises, but you need to keep your wits about you for awhile. I'll take you to the fish fry too. Maybe somebody's caught another giant crawfish from the river. You haven't lived till you've tasted fresh-boiled crawfish steaks in sphinx butter. Melt-in-your-mouth delicious it is, and well worth the price . . ."

**SKYREALMS of**  
**Jorune™**



**"L.A. in July,  
Milwaukee in August,  
and then, ahhh . . .  
back to Jorune."**

The complete role-playing game: \$25 (mail order: add \$1.50 for shipping). For more information, contact your dealer or distributor, or write to us directly at 526 MISSION • SANTA CRUZ • CA • 95060 • 408-429-9938.



**Leave Your World Behind**

# FLASHING BLADES™



A complete role-playing game of swashbuckling adventure set in the era of the Three Musketeers.

Basic rules covering:

- Character Generation
- Careers & Professions
- Advantages & Secrets
- Combat
- Skills
- Advancement
- Detailed Background

FLASHING BLADES comes with the complete rules of play, introductory adventure book with three adventures to get your campaign going, a master character sheet (suitable for photocopying), and a gamemaster's screen of the important charts and tables for easy reference. This is all you need to begin a campaign in a time when the rivalry between King and Cardinal changed the course of history across France and all of Europe. **\$12.00.**

Also Available: **PARISIAN ADVENTURES** for use with FLASHING BLADES. Including 4 adventures, a guide to 17th Century Paris, and exotic items . . . **\$5**

Available from better shops worldwide or direct from us at:  
P.O. Box 182, Roslyn, N.Y. 11576 (USA).  
Please add \$2 for post and handling. NY residents please add sales tax.





# DUNGEON™ Adventures

## What readers and writers need to know about it

by Roger E. Moore

---

In DRAGON® issue #107, we announced that TSR, Inc., would soon produce a new periodical filled with modules — though a few things remained to be resolved, such as choosing a name for the periodical. Happily, that part's been taken care of.

This article presents some basic information about the new periodical — entitled DUNGEON™ Adventures — and also presents guidelines for writers who would like to share their game adventures with the rest of the world. You will also find a subscription card for DUNGEON Adventures elsewhere in this issue, with complete information on ordering a charter subscription.

DUNGEON Adventures is a bimonthly periodical that is 64 pages long and that focuses exclusively on the AD&D® and D&D® role-playing games. Each DUNGEON issue costs \$3.75. A one-year subscription (for six issues) is being offered now for only \$15.00 through October 31, 1986; the regular subscription price thereafter will be \$18.00. The first issue is scheduled to appear in September 1986. See the subscription card in this issue for more information.

Each DUNGEON issue will have a number of game modules within it, varying in length from brief encounters to modules of about 16 pages length. We plan to offer a wide variety of adventures for different character types and levels in a variety of formats (standard types, solo modules, tournament modules, competition adventures, etc.). We are open to submissions of modules from all gamers and readers of DRAGON Magazine.

Currently, we are only interested in receiving module submissions on the AD&D game and the D&D game (for Basic, Expert, Companion, Masters, or Immortals levels). BATTLE SYSTEM™ and *Oriental Adventures* modules are also acceptable. We will not look at modules which have been simultaneously submitted to another gaming magazine or company.

Read these guidelines carefully before you send any modules to DUNGEON Adventures. If you have any questions which are not answered here, we will respond as quickly as possible to inquiries as long as they are accompanied by a self-addressed, stamped envelope. Please do not telephone us to ask questions.

### Queries and forms

Before you submit a module to DUNGEON Adventures, you should write

to the editor and send a brief proposal of the adventure you wish to create. A one-page description that highlights the adventure, including the types of characters for which it was meant, the treasures to be gained, and the foes to be overcome, would be sufficient. Be straightforward and outline the nature of the adventure clearly. Also enclose a self-addressed, stamped envelope for a quick response to your module proposal. The address is:

Roger Moore  
Editor, DUNGEON Adventures  
TSR, Inc.  
P.O. Box 110  
Lake Geneva WI 53147

The age, sex, race, nationality, ethnic group, and religion of a person submitting a module to us make no difference in our evaluation of that module. If you are under age 18, your parents or guardians will need to co-sign certain documents for you, but that does not prejudice our evaluation. Our judgment of a module rests solely upon the quality of the work itself. If you express yourself well, have good ideas, and can type well (or know someone who will do it for you), you have a good chance of seeing your work in print.

If your idea seems acceptable, you should receive a reply in a few weeks, along with a Standard Product Disclosure Form, which you will need to fill out. When you submit your completed module, the Standard Product Disclosure Form should be returned with it. You may make copies of the form to submit with other adventures.

Because module evaluation is time-consuming, and because we cannot guarantee that our regular working duties will allow us the time required to check over a module thoroughly and carefully, we ask that writers allow us 90 days to go over a module. If we discover that a module violates a number of the more important guidelines given herein (for example, the manuscript arrives as a poor photocopy on slick paper, is handwritten, and has a surprising number of spelling errors and instances of bad grammar), we will reject the work immediately without reading it to any great depth. Writers are strongly advised to avoid wasting both their time and ours by adhering to these guidelines and by querying us by mail when necessary.

### Rights and payment

Any module published in DUNGEON Adventures becomes the sole property of

TSR, Inc., and of DUNGEON Adventures upon payment to the author for the purchase of all publication rights. Payments are made within 30 days after publication of the module, at a basic rate of \$0.04 per word. Artwork and maps which are of publishable quality will be purchased at our standard rates. In almost all cases, however, the maps and artwork are drawn or redesigned by other artists, and the original artist receives \$100 per full magazine page of maps used.

If two or more persons collaborate to create a module, please tell us how we should divide all payments. Also provide the addresses and Social Security numbers (for tax purposes) for all those who are to be paid.

You cannot retain copyright of your module or of its contents if you wish to sell it to us; we must purchase all rights to it. We do not offer royalties on the modules we purchase; instead, we pay a flat fee. Module work is considered work for hire, not assigned work, unless such has been specifically agreed upon by the editor and the author. We cannot offer kill fees for most rejected manuscripts, except for assigned works.

We do send the author of the module two free copies of the DUNGEON Adventures issue containing the published work. Once published, the author may contact the Acquisitions Department of TSR, Inc., and offer his services as a free-lance writer. We may also contact the author for creating other game modules for our periodical.

### Correspondence

Always enclose a self-addressed, stamped envelope with your module submission, and should the module require revisions or be unsuitable for use, make sure that the envelope is large enough to hold your entire module in case we return it to you. Even if you sent us a photocopy of your adventure or have your module recorded on computer diskette, we would prefer to return the entire module, as we may have noted specific problem areas in the text itself. We never respond to a writer who does not enclose some form of SASE with his manuscript, and we are under no obligation to return manuscripts that arrive without SASEs.

If you wish to be notified of our receipt of your manuscript, you can either send your module to us by registered mail or enclose a self-addressed, stamped postcard with your module for a quick reply from us. We won't

be able to inform you immediately as to the acceptability of your module, but the postcard will let you know the manuscript arrived safely.

We cannot assume responsibility for the transit and safekeeping of any module sent to us, so it is a good idea to keep one copy of your module in your possession.

### Physical quality of modules

Modules should be sent to us in printed form, either typed or produced on a word processor with clear, **dark** print — letter quality is preferred. Print on one side of a page only, and use clean white sheets of paper, preferably 8½" x 11" in size. The lines **must** be double-spaced to allow editorial insertions. Small corrections may be made on the manuscript and maps (i.e., correction of a misspelled word or insertion of a short phrase) so long as the changes are neatly done, legible, and few in number.

Consider putting a fresh ribbon in your typewriter or printer before producing the final version of your module. Also make sure that the typewriter keys are clean and that they do not punch holes in the paper. Do not have the module printed with all the letters in capitals; nor should you use Gothic type, calligraphy script, or any other fancy lettering. We won't even look at modules that are handwritten in pencil or pen.

If you send a photocopy of your module to us, ensure that it is on letter-quality paper. Slick, excessively gray, or streaked photocopy paper is not acceptable.

We cannot have modules sent to us by computer modem or on floppy diskettes. Send hard copy only.

As a rule of thumb, assume that five pages of pica-typed, double-spaced material with 1" margins equals one page of solid text in DUNGEON Adventures. Because of the limitations posed by the periodical's size, keep module submissions to a maximum length of 60 typed pages. If you wish to write a longer module (or a series of modules), query in detail first.

Consistently poor spelling, grammar, and sentence structure will almost certainly cause a module to be rejected. Even if you feel that you have a strong grasp of English grammar and that your module idea is good, you should have the module proofread by at least one other person, preferably an English teacher or professor. We don't insist that manuscripts be perfect, but we look more favorably upon those which require little editing.

### Artwork and maps

A finished module should be accompanied by all relevant maps and diagrams needed to complete the adventure. Additional drawings, sketches, and charts may be added to clarify various points. Artwork suggestions may be made, though they might not be used.

Design maps so you include the title, key, scale, and compass rose. Try to leave at least ½" margin on all sides of an 8½" x

11" sheet. Standard formats will allow maps up to twice this size, but any larger requires special handling.

Make sure that all artwork sent with the module is neatly prepared in ink; pencil sketches are not acceptable. Maps should be sketched in ink and should be clearly legible. The map grid (square or hexagonal) should be clearly marked without obstructing the map's legibility. Use a straightedge to draw the straight lines on your final copy, and darken solid areas (such as solid rock around a dungeon complex).

Remember internal consistency when designing maps. Inhabited areas require provision for bringing in food, water, light, and heat, provision for venting of waste materials, and provision for the inhabitants to get around easily. Large area maps should conform fairly well to known geographical principles — special cases might be noted.

Always check your maps against the finished module text. Make sure you have described all relevant areas on the maps and have not mislabeled anything. Have someone carefully proofread the maps as well as the text. Don't let us catch your mistakes for you.

### Module contents

An AD&D or D&D game module should contain the following elements:

- \* A description of what sorts of player characters (classes, levels, races, etc.) would be best suited for the adventure, the characters' briefing before the adventure, and what equipment and special information they need-or will be given at the mission's start;

- \* A Dungeon Master's briefing, giving the background of the adventure — this section should be reasonably long and detailed;

- \* A description of the adventuring environment with all details relevant to the adventure supplied (including maps and other illustrations);

- \* Complete information on running the adventure, including special rules, non-player character statistics and possessions, possible encounters, information and items to be discovered, rumors, details on new magical items, spells, monsters, weapons, and any other material that would be helpful to the Dungeon Master or players; and,

- \* A description of the possible consequences resulting from the adventure's success or failure, including rewards, punishments, and spin-off adventures for later gaming sessions.

It is not necessary for an adventure to include statistics for the player characters involved, as players usually wish to bring their own characters. Tournament modules, however, must include pre-generated player character information for 4-8 players.

### Module settings

AD&D game modules should not be tied to any one specific game world and should be easily adaptable to most Dungeon Mas-

ters' game campaigns. We ask that module designers not locate their adventures in the WORLD OF GREYHAWK™ Fantasy Setting and avoid using particular personalities, countries, politics, and so forth that relate directly to that game universe (e.g., Mordenkainen, St. Cuthbert, Vecna, etc.). We will reject modules of this sort without reading them.

However, we are open to submissions set in the world of Krynn (the setting for the DRAGONLANCE™ adventures), though we may insist that the adventure conform to the particular nature of that world setting. "The Known World" of the D&D game (as featured in many of the rule books and modules for that game) is also open for further development.

In the final analysis, we would still prefer to get modules which are not tied to any game world, as noted above. Most Dungeon Masters prefer it this way, as they may drop the adventure directly into their own game worlds, of whatever design.

We encourage you to read books and see movies with fantasy themes if you want to develop an AD&D or D&D module. This can be excellent for putting you in the mood for writing your module and catching the feel of fantasy adventures. However, avoid using any settings or material extracted from copyrighted sources. Anne McCaffrey's Dragonriders of Pern books, Piers Anthony's Xanth series, Robert E. Howard's Conan novels, Michael Moorcock's Elric series, Katherine Kurtz's Deryni books, J.R.R. Tolkien's Lord of the Rings series, and the Cthulhu mythos created by H.P. Lovecraft — all are good examples of material that cannot be used in your module submission.

### Design tips

It is essential that you be completely familiar with the AD&D and D&D games if you are designing a module for them. You may find it helpful to re-read the rules several times as if you were studying them for a test. Reading the rules through during the time you write the module can also be a help.

It is also essential that writers be completely aware of the differences between the AD&D and D&D game systems, which do not mesh despite their similarities. A dwarf in the AD&D game is a racial type but not a character class; in the D&D game, it is both. These game systems are independent and have different monsters, magical items, spells, character classes, and time and movement scales. Do not confuse them in your text.

An axiom of module design is that, in order to write a module, one must study modules. You are strongly urged to find copies of modules that have been published in DRAGON Magazine or by TSR's games division and study them closely for content, presentation, overall design, types of materials included, map layout and design, and so forth. Don't read just one module, either. Study several of them, discuss them with

your co-designers or friends, and learn from them. You will also find it useful to read the other AD&D and D&D game modules published by TSR, Inc.

Encounters should be described fully whenever possible. If your module is exceptionally long or if we need trim it for space, some specific details on encounters may be dropped (but let us do that). Make sure no relevant details of encountered beings are left out (such as hit points, alignments, or strength scores). The weapons and equipment carried by an NPC, along with relevant personality and reaction notes, should be given with the first mention of the character where appropriate. All encounters, NPCs, hazards, rewards, details on the environment, and special information required for combat, altering the environment, or accomplishing the mission should be detailed sufficiently to allow the referee and players to run through the scenario without trouble.

It is vital that the majority of encounters in an adventure relate directly to the adventuring goal. Excessive use of random encounters works against the adventure. Encounters which are interconnected and critical to the adventure's plot are best.

Illogical adventuring set-ups in which monsters and treasure are randomly thrown together should be avoided. This does not mean one cannot use random encounter tables, but the tables should be logical and consistent with the adventuring environ-

ment, making the overall adventure sensible and believable.

Indoor complexes laid out in perfect symmetry are boring; use your creativity, even if the final result isn't perfect architecture. Imagine what settings would be most interesting and exciting for adventurers, and go with those. Avoid using excessively large maze areas in dungeons or indoor areas, as these are boring and dull.

Situations in your module which violate established AD&D and D&D game rules should be handled carefully. Certain parts of the games should not be altered without extremely good reason (such as the "to hit" or saving-throw tables). Other alterations, such as new monsters, treasures, or society types, are permissible, but should not be overused. One may also add new material to a module, of course, that expands upon the old rules, such as details on adventuring in an unusual environment.

Don't overreward players or underchallenge them. We will reject modules in which mighty fortresses are guarded by weak guards or in which players can walk off with diamonds the size of cars. Take the time to make the rewards consistent and believable as well as balanced. Conversely, do not create opponents in an adventure that would totally overwhelm a party. If you must use an exceptionally powerful being in an adventure, there must be a good reason for it, and it must be carefully handled.

We have few other definite rules about how a module should be put together for **DUNGEON** Adventures. We're willing to take a look at any innovative ideas which involve changes in a module's structure, setting, the nature of the adventure, and so forth. Such innovations should not, however, interfere with the understanding and use of the module, and they should enhance both the module's playability and the gamers' enjoyment.

#### Ideas to explore

Modules that present new magic items, monsters, weapons, or NPC classes are valuable, but not so much so as modules which present a fast-paced, exciting, enjoyable adventure. Avoid introducing more than four new things in an adventure. If you create something new for the game, make sure that its presence in the module is justified, that it is fully explained in terms of its effects in the game, and that it is reasonable and fits in with the game rules.

We would be interested in seeing tournament modules, solo modules, modules designed for special groups of player characters, and any other unique adventures, but our basic interest is in modules which can be used by the widest number of gamers, using a broad mix of character types and equipment. If we get too many modules of a particular type (such as solo modules), we may refuse to accept any new such modules for a certain period of time.

As noted above, short adventures or encounters are being sought which can be easily dropped into an evening's game time.

Unusual monster lairs, city encounters, and small ruins may be presented, but each should also be unique, interesting, and detailed.

A series of modules is another matter. Please check with us before starting any extended series. The ground rules are:

1. Each installment must stand alone;
2. Each installment must be consistent with the others in plot line, detail, and writing style;
3. For preplanned epic quests, we would want the whole thing in hand before we evaluate the whole.

Unusual natural environments should be explored (but avoid using the Outer Planes for now). Modules that detail unusual fantasy cities (underground dwarven enclaves, elven forest towns, undersea cities, etc.) would also be appreciated, though human cities are very welcome if they are unique in some manner. Good city adventures are hard to acquire.

The most important thing in a module is the hardest thing to define. Look at your module as if it were a movie script. Would you want to see a film like this? Would it keep you on the edge of your seat? The best modules entertain and challenge gamers, giving them something to remember.

#### Ideas to avoid

Avoid stereotyped, cliché-ridden material. Do **not** have your character party rescue someone's kidnapped daughter, meet any real-life personality, or race against time to save the entire planet from a horde of demons coming out of the Abyss. The latter concept (with all of its variations) is not only trite but openly destructive to game campaign continuity.

High-level adventures should have the balance of the game kept in perspective and should challenge the players without damaging the referee's world set-up. Adventures tailored for the killing of deities or the saving or ruining of worlds are not likely to be accepted.

Tastelessness should be strictly avoided. Do not write adventures involving the destruction of children and helpless persons, excessive gore or violence, descriptions of Satan or Satanism, or game versions of major Christian, Jewish, or Moslem religious figures. Explicit sex, the encouragement of drug abuse, offensive language, and bathroom humor cannot be used. We have a responsibility to keep our material exciting but inoffensive.

Do not use non-player characters (NPCs) to help the player characters excessively. NPCs who step in and eliminate all opposition to the player characters, accomplish their goals for them, and generally do everything the players want or need from the adventure are very dangerous to campaigns; boredom sets in at once. Set up the adventure to challenge the players and let them make it or break it on their own.

Avoid game hybrids and crossed campaigns; don't have your AD&D game char-

*(Turn to page 26)*



**It's Point Blank**

Nobody offers a larger selection of fantasy/adventure games, war games, miniatures and accessories. Write for our free catalog today.

**THE OMPLEAT STRATEGIST**  
Adventure Game Headquarters  
Fantasy and Wargame Headquarters

ORDER TOLL FREE **800 225-4344** Amex/MC/Visa \$10 Minimum

Visit the fantasy and war game headquarters near you:

NY:	11 East 33 Street, New York City, NY 10016	(212) 685-3880
	320 West 57 Street, New York City, NY 10019	(212) 582-1272
MA:	201 Massachusetts Avenue, Boston, MA 02115	(617) 267-2431
VA:	103 East Broad St., Falls Church, VA 22046	(703) 532-2477
NJ:	215 Glenridge Avenue, Montclair, NJ 07042	(201) 744-6622
FL:	5406-B Stirling Road, Davie, FL 33314	(305) 961-8560
PA:	254 W. DeKalb Pike, King of Prussia, PA 19406	(215) 965-8560
	2011 Walnut Street, Philadelphia, PA 19103	(215) 563-2960
MD:	231 Park Avenue, Baltimore, MD 21201	(301) 752-1493



# DETAIL WHERE IT COUNTS.

AND IT COUNTS WHEN YOU'RE BUILDING THE FINEST FLEET IN THE UNIVERSE.

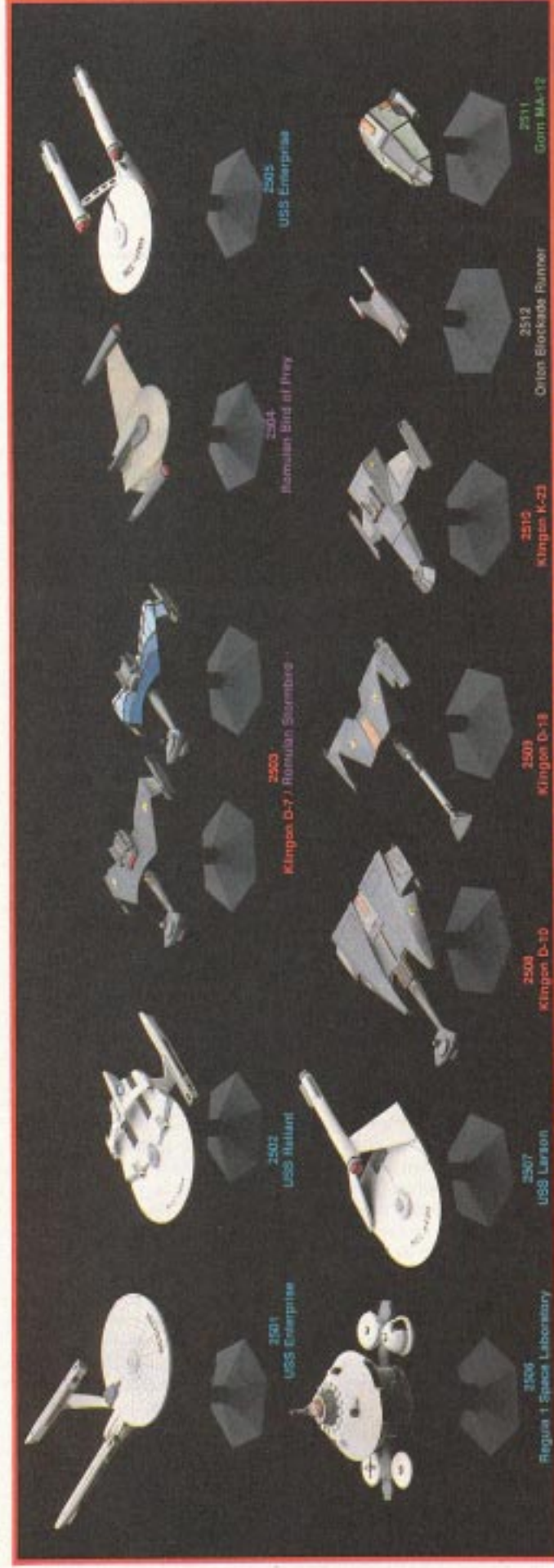

## THE OFFICIAL STAR TREK STARSHIP MINIATURES

Discriminating Fleet Admirals everywhere prefer the FASA Star Trek starship miniatures so much that the ships outsell all their competitors everywhere, and in 1985, they won the H.G. Wells Award for Best Vehicle Miniatures.

Cast in white metal, these miniatures are popular because of fine detailing and easy assembly. With a little super-glue and about ten minutes' time, you can put together the finest starship on the market. Then, just use your favorite paints to create the famous vessels of *Star Trek* or your own designs or patterns. Each miniature also comes with a hex-shaped mounting stand designed to fit the maps of the *Star Trek Starship Combat Game* (#2003). Throughout 1986, you'll be able to expand your fleets with new Starship Miniatures forthcoming from FASA. So, whether you are a *Star Trek* fan, a miniatures collector, and/or a gamer, accept only the best. Put FASA's *Star Trek Starship Miniatures* in your fleet today and start exploring strange new worlds.

Miniatures not shown are: #2513 Klingon L-9 (Frigate), 2514 USS Loknar (Frigate), 2515 Romulan Winged Defender (Cruiser), 2516 USS Chandley (Frigate), 2517 USS Excelsior (Battleship), 2518 Klingon L-42 Bird of Prey (Frigate), 2519 USS Grissom (Research), 2520 Deep Space Freighter, 2521 Romulan Graceful Flyer (Scout), 2522 Orion Wanderer, 2523 Kobayashi Maru (Freighter), 2524 Romulan Gallant Wing (Cruiser), 2525 Gorn BH-2 (Battleship), 2526 USS Baker (Destroyer), 2527 Romulan Nova (Battleship), 2528 Romulan Bright One (Destroyer), 2529 Klingon L-24 (Battleship), 2530 Klingon D-2 (Destroyer), 2531 Romulan Whitewind (Cruiser), 2532 USS Northampton (Frigate), USS Remora (Escort), USS Andor (Missile Cruiser).

For a catalog of FASA products, send \$1.00 to:

**FASA**  
CORPORATION  
P.O. Box 6930  
Chicago, IL 60680

Available Only at the Finest Game, Hobby, and Bookstores in the Universe.

# No campaign ever fails

## What to do if your game gets out of control

by Joel E. Roosa

---

Valandar, Lord of Eldor, General of Generals, and 23rd-level fighter, pulled on his shimmering, golden *plate mail* +6. He buckled his *girdle of titan strength* about his waist and hefted his *sword of disintegration* +6. Then he surveyed himself in his *mirror of healthful reflection* and deemed himself fit to battle the dragon that had been ravaging the countryside.

In another universe, Gelkin, a 4th-level fighter, put on his *chain mail* +3, unsheathed his *longsword* +1, and lifted his *shield* +2. He woefully thought of the few gold pieces remaining in his pouch and hoped to find an adventure that might pay enough to live on for a while.

The preceding paragraphs give examples from hypothetical campaigns, one well-balanced and one "Monty Haulish." Which is which may not be obvious.

Valandar was run for nine years of real time, gained two to three levels per year, and undertook extremely dangerous quests. He has an impressive array of equipment, but none of it has ever made any adventure a cake-walk.

But Gelkin got all his equipment and levels during *one* adventure.

To further illustrate, we visit Valandar and Gelkin a few hours later.

Valandar, Lord of Eldor, limped into his chambers, his battered and bloody armor squeaking as he moved. In his right hand he held the useless stub of his former sword, which still steamed from the dragon's blood. With a curse on the corrosive fluids in a dragon's body, he cast the sword fragment away. Perhaps it could be made into an enchanted nail file for his wife.

He gazed forlornly at his blackened waist, where his *girdle of titan strength* once hung. "Under the armor, under the armor!" he shouted. "Wear magic belts *under* the armor!"

He peered into his *mirror of healthful reflection* and immediately felt his wounds begin to heal. His armor wasn't so lucky. Perhaps the master smiths could repair it — but perhaps not.

Meanwhile, Gelkin, slayer of goblins, surveyed his handiwork. Three dead orcs and an open chest lay before him. He was now 5th level and had enough gold for months. Gelkin pulled his newfound sword from its scabbard and learned that it was a *vorpal weapon* +5 and also had the abilities of a *staff of the magi*. "Neat," he said.

Campaigns cannot be neatly categorized on the basis of a few examples from them.

After getting the definition of some terms out of the way, this article will examine the problems that crop up in many campaigns and how to deal with them.

A "campaign," in the fantasy role-playing sense, is a series of adventures with an overall connection. It usually involves either recurring groups of characters, settings in the same world (or related worlds), or both.

A properly run campaign is usually called "balanced." A poorly run campaign is called "unbalanced." I prefer the terms "controlled" and "uncontrolled," respectively. Often, when a campaign has become uncontrolled for a long period of time, it is called a failure.

Individual adventures can indeed be failures, but as a whole, no campaign ever fails, and any campaign can be controlled.

### Recognizing uncontrolled campaigns

Most articles about "failed" or "Monty Haul" campaigns warn about the dangers of overly powerful characters upsetting the "game balance." Game balance is a relative term. Over-powerful characters from one game may be under-powered in another.

Obviously, a campaign in which players use gods of the Egyptian pantheon as player characters is in a different class from one in which all player characters are halflings. If Ra were to enter the halfling campaign, the halfling players might consider him to be from an uncontrolled campaign. They might be right, but a given campaign *must* be judged separately from other campaigns. Game balance therefore depends on the internal workings of each individual campaign.

To determine if a campaign is out of control, evaluate the following:

1. *Have most of the characters achieved their levels fairly without undue "favors of the gods," and through real danger to the characters?* "Fairly" can even mean starting all characters at 2nd level or higher, as long as all characters have the same chance (although I prefer that all characters start at 1st level). "Favors of the gods" can include *wishes* that raise levels, *decks of many things*, and various magical tomes. Experience gained without risk is a gift. In one adventure, the DM granted my party full experience points for burning to death three defenseless treants. Gaining a level per adventure, or even per two to six adventures, is too fast.
2. *Has magical or technological equip-*

*ment been mostly earned by real effort?*

Gaining a magical sword by chopping a tree down with a herring might count as real effort. Freeing a sword from a block of ice with a blowtorch probably wouldn't. Of course, if the herring were highly enchanted, or the character has to *invent* the blowtorch, it might be different. Magical items lying unguarded behind normal secret doors take no great effort to acquire; ones behind trapped secret panels with special opening codes would.

3. *Do most of the characters find the greater share of the individual adventures challenging?* By "challenging" I don't mean vaporizing Lolth as an appetizer, destroying Demogorgon for the main course, and annihilating Yeenoghu for dessert. By "challenging" I don't mean a crippled goblin killing three out of six characters. By "challenging" I mean an adventure that makes the characters exert their abilities to a great degree, makes them worry about survival, and gives some of them wounds to remember. An adventure doesn't have to kill any characters to be challenging. My adventures kill characters rarely, maybe once every twenty adventures or less. Challenges can also be mental — puzzles to solve, traps to figure out, and so forth.

4. *Most importantly: Is most everyone having fun?* This includes the DM as well as players. Not all players enjoy a particular DM's style, and vice versa. Not everyone in a group will always care for the particular adventure they're on. Some players like certain types of adventures and prefer DMs who oblige them. Some prefer hack-and-slash, some like "thinking" adventures, some like very controlled, narrow-purpose adventures, and some just like to roam and have random encounters. The different types of players are not necessarily incompatible. One player's favorite saying was "wake me when the fighting starts." He wasn't the least interested in solving riddles or bargaining with merchants; he let the others do that. His character fought and he was happy. On the other hand, another player preferred to leave the fighting to others while he lived by his wits.

Each "yes" answer to the above questions is worth 1 point, each "no" worth 0. Total the points and continue with the following section.

5. *Are any characters too powerful?* Power is a relative term. An 8th-level

# WHAT THE @!¢%\*# IS GURPS™

*GURPS* is a whole new approach to roleplaying — a game in which ease-of-learning, ease-of-play and realism go hand in hand. The rules are written in plain English. You won't need to learn a new language to play the game.

*GURPS* puts you on the battlefield with fast-paced combat. But realism and tactics aren't sacrificed for "playability."

And the battlefield can be anywhere, anytime. The *GURPS* system can handle any fantasy setting, any real-world setting — past, present, or future.

*GURPS* characters are more than the cardboard cutouts in most roleplaying games. Create characters just as you envision them — three-dimensional and easy to roleplay.

And the *GURPS* system is modular. You won't have to redesign the rules to suit your own needs. For the first time, you'll be able to choose the exact level of detail you want.

*GURPS*. The product of five years of development. The most flexible game system ever designed. The state of the art in roleplaying. The game you'll want to play.

**GURPS. Not the first RPG. Just the best.**

Watch for the *GURPS* Basic Set at your game store or send \$27.50 (Texas residents add \$1.00 sales tax) to:  
Steve Jackson Games, Box 18957-D, Austin, TX, 78760

*GURPS* is a trademark of Steve Jackson Games Incorporated. All rights reserved.



fighter with 18/00 strength, 70 hp, and a sword +3 is godlike compared to a 1st-level fighter with average strength, 5 hp, and a normal broadsword. The same 8th-level fighter is weak compared to a 15th-level fighter with a *girdle of storm giant strength*, 140 hp, a *holy avenger* +5, and *plate mail* +5. "Too powerful" means characters who easily win their fights. Every character has easy lights, but if they are always easy and the characters rarely have a serious challenge, then they are too powerful.

6. *Are there too many powerful magic items in the campaign?* This includes technological devices and other high-powered special equipment such as items of artifact status, *spheres of annihilation*, +5 weapons, and anything that lets characters win fights all the time. By too many, I mean each character having such items. Even lesser items could amount to the same thing, if characters have wagonloads of them.

7. *Do the characters have too much money?* Enough gold to unbalance the economic structure of a country is too much. Enough money to buy everything of substantial value in the capital city is probably too much (unless the characters already rule the city). The money inherent to high social class (nobility or royalty) isn't usually a problem.

8. *Do the characters have too much manpower available?* This can mean any kind of henchmen or hirelings, human or otherwise. This can be related to having too much money. The situation I refer to is in the dungeon. Many players like to hire cannon fodder to set off all the traps and test all the potions. Worse, they like to have small armies do all their dirty work, like killing all the dungeon inhabitants. There is a place for armies on the battlefield. Adventures usually work best when the characters themselves must face the dangers.

For questions 5-8, each "yes" answer is worth -1 point; each "no" is worth 0. Total all the points from both sets of questions and consult the results section below.

## Results

+ 4 = Excellent campaign. Depending on the imagination of the DM (and the players), it could be a great campaign.

+3 = Good campaign. It has a problem or two, but probably nothing a little effort couldn't fix. If it lacks fun, then it may be mechanically correct, with no heart.

+ 2 = Fair campaign. Many campaigns, especially first-time ones, are of this type.

+ 1 = Mediocre campaign (and likely to get worse unless some serious fixing is done).

0 = Poor campaign. Any good points are balanced by equally bad points. Then again, there may be no good points, but no particularly bad points.

- 1 = Awful campaign. Bad points outweigh the good ones. It may be played because flaws are overlooked. It can still be fun.

- 2 = Terrible campaign. At best it could still be fun and challenging, but it isn't likely to be that way for long.

- 3 = Miserable campaign. Hopefully still fun, but it's probably fading fast and played mainly out of habit.

- 4 = Pitiful campaign. No longer even fun, unless you enjoy being tortured. Its players are extreme die-hards, or the DM may be an egomaniac who refuses to admit anything is wrong.

If your own campaign has a rather low score, don't be depressed. Despite the problems a campaign may suffer, it can't suffer failure unless allowed to do so. Campaigns can be severely damaged by lack of proper control, but any damage can be fixed. Even a - 4 campaign can be regenerated.

Some might say, "You don't know what you're talking about. Our campaign is still fun, and that's what counts!" It's true that fun is the most important aspect of the game. Without it, there isn't much point in playing.

But eventually, the flaws in a fun campaign are likely to worsen to the point where no one is having fun any more. If brought under control, the flawed (but fun) campaign will be even more enjoyable. The following section offers some solutions to the problem of uncontrolled campaigns.

## Repairing uncontrolled campaigns

First, pinpoint the problem using the section above. This article assumes that the player characters have gotten out of hand in some way, without laying the blame on either the DM or the players.

If the characters are too powerful, determine how so. Are they of vastly high level? Do they have high ability scores? Unusual powers? Powerful magic or technological items? Enormous wealth? Great armies?

Ability scores and levels go together to create physical power in the AD&D® game. A 1st-level character with a 19 strength still dies as easily as any other 1st-level character. Only when awesome ability scores are backed by high-level hit points do we get the "superman" effect.

I don't consider ability scores less than 19 to be a problem, unless most or all of them are 18's, which is not only boring but unnatural. Only unbelievable luck, cheating, or magical increases will produce such a character.

Prevention is easier than cure. I never let my players roll ability scores with more than three dice, except for demi-humans (best three of four dice in strength and constitution for dwarves, the same in dexterity and charisma for elves, etc.), nor do I allow the raising of one score by the lowering of another. Of my own 50-odd characters, I have one paladin and one illusionist. I've always thought they were meant to be rare, and have always made it so.

I do, however, allow the increase of ability scores by training, so that low scores may be increased while level increases. High scores are rarely increased. Of course,

fighters do not raise intelligence, nor magic-users strength. Intelligence is limited to a +2 increase, the only ability I limit (except for comeliness, which usually increases only if charisma does).

Characters who are on their way to god-like levels and attributes can be reined in by many means. Levels can be drained by undead who have strong connections to the Negative Material Plane. If undead present no great threat, a *gate* to the Negative Material Plane could be opened. The characters would be forced to close the *gate* or perish. In closing the *gate*, the characters could be drained of both attributes and levels. If kept away from *restoration* spells long enough, the level drops would be permanent. Lost ability scores could be gone permanently, partially restored by the forces of good, or regained over a period of time. A quest for a greatly desired item could break PCs both physically and mentally (lowering some ability scores by a few points) but give them the item they desire.

Sometimes, one or more characters in a group may be too powerful for that group. This can be a sign of the campaign going out of control, but remember, anyone can be a wimp or a warrior. Power is relative to the strength of encounters, the strength of the party members, and the average for the campaign as a whole. A weak character from one group can be powerful in comparison to another group, and vice versa.

Almost everyone in my campaign has three or more characters of varying power levels. Most characters have a regular set of companions they adventure with, and the players don't try to bring their tough characters in with a weak group unless it fits the scenario I'm planning.

Characters will not usually outstrip their companions greatly if the characters all started together and adventure together, providing all had equal chances for good or bad characters. Although characters may excel by luck, skill, or both, often the over-powered characters come from another campaign or from higher-level groups in the same one. This is the usual way of it in campaigns with which I am familiar. Sometimes, characters advance beyond their fellows simply because they have adventured more. This often occurs when a player group is broken up by college, career, or the relocation of families.

Whatever the reason, a DM will occasionally be faced with a player who wants to bring in a character from another group. Although there is basically nothing wrong with that, some DMs will not allow it. No DM has to let any character into a campaign if he doesn't want to do it. The DM is the final authority in his campaign. Although my campaign has had its share of problems, I've never had trouble from crossover characters. While I've allowed almost any characters into the game, I've placed them with equivalently powered groups or else trimmed their powers until they were made to lit in with the other PCs.

Anyone entering a game controlled by

you is subject to *your* rules. If players don't wish to have their PCs' powers altered or reduced, they don't have to play in your game. Players may have their PCs weakened only for the duration of their stay, or they may accept permanent alteration of their PCs. Make sure the players are informed of this *before* they bring in their characters. A favorite technique of mine is to have the means of arrival to my world (*gates*, spells, mystic explosions, summonings, etc.) be the means of their alteration. For example, NPCs may take magic items in trade for transporting characters to my world, good gods may "cleanse" evil characters so they can adventure with good ones, mystic explosions may alter characters in attributes and levels, and dimensional "police" may forbid certain items to be brought into my world.

If, despite everything, your campaign has characters far beyond the rest in terms of personal power, other options exist. The easiest solution for me was to craft adventures with a very tough, central adversary surrounded with lesser underlings. As a matter of course, a powerful character would seek out a fight with the major foe, while everyone else mopped up the lesser beings. The tough guy needed the help because he would have been swamped otherwise. Everybody fought, everyone was busy, everyone was happy.

Another way is to create adventures in which a character's power is useless. An adventure requiring the solving of riddles is one example, since the player must depend on his own cleverness, rather than the character's power, to solve problems and finish the scenario. This balances things well for everyone.

If a character is still too powerful for a particular group, there are other measures that can be taken. The DM can talk to the controlling player, who may agree that something should be done to make things more workable. It could be a matter of — giving up some items or taking voluntary cuts in some powers or abilities. The character could be retired until the rest of the group catches up, or it could be played with a more powerful group, if one exists. Or the character can go adventuring alone, which gives the DM a chance to make more demanding adventures without killing weaker characters.

The character may also be run as an NPC by the DM if the player agrees. The DM would then assume control of the character, possibly allowing the player to use it on special occasions. If the player wishes to be helpful, he may give powerful items to the gods or to wizards until such time as they are needed again, or the items may be sacrificed to stop a great evil. Personal power could be passed to others or mysteriously returned from whence it came.

Some characters might simply not use certain powers or weapons. The great warrior Vendil, for example, uses only his 18/00 strength and his bare-hands on most opponents he meets, saving his *sword* +5 "for a

truly worthy foe."

If the player doesn't see the problem with his character, the DM may have to take other actions. Killing out-of-control characters is one solution, but I believe in being fair. Destruction is easy; any DM can kill any character if he really wants to, but I abhor off-handed destruction of PCs. I believe in giving every character a fighting chance for life. Try to solve problems creatively; creation is always harder than destruction, but is worth it. Above all, be fair!

If the main problem is an excess of powerful magic items, it can be handled in much the same manner as physical prowess was handled. It is only the *psychology* of owning magic items that is different. For many players, magic is the most interesting thing in a fantasy campaign; the role-playing aspect of the game often takes second place to the power and glitter of magic items. Instead of developing the character as a person, it becomes far easier to define him in terms of his possessions.

To satiate the cravings of players for magic items, the DM can create items that are flashy but not powerful — i.e., they will impress local peasants but not slay dragons. This process also satisfies the desire of the DM to create new magic items. If done properly, the DM can create items that become more powerful when their owners behave in certain manners. Thus, the players are forced to role-play with their characters more often when they must act noble, macho, or crazy.

Another type of possession is money. Occasionally, characters will acquire enough money to make them an economic power to be reckoned with. This may unbalance the DM's setup of the game. In my campaign, I once used a pre-packaged module featuring a dragon that possessed a tremendous hoard with great heaps of gold. Since no gold piece value was given, I decided that 100 million gp was appropriate. Naturally, the group destroyed the dragon, leaving four people with 25 million gp each. Well, since gold was worth more in my world than in the typical AD&D game world, I soon decided I had made a major mistake. Here are some methods I could have used to fix the situation:

*Steal it back.* Such a large amount of gold (5,000 tons) takes a lot of wagons, equipment, and time to move. Such a lengthy project would be hard to keep secret. Thieves could get wind of it and hijack the caravans moving the metal. If an army was hired to guard it, the mercenaries might turn traitor and hijack the gold themselves. Even if the group decided to make the dragon's lair their base and *not* move the gold, other treasure seekers will eventually come after it once they learn the dragon is dead. Powerful forces may decide *they* deserve the gold, forcing the PCs out. Other dragons may come to avenge their brother (just possibly lured by the treasure, too). Gold is a powerful lure, especially in such amounts and especially to dwarves, who may decide to claim the gold out of sheer

greed or as a just "inheritance." After all, the gold belonged to someone else once, and the original owners (or their descendants) may show up, too.

*Swindle it back.* The characters suddenly discover friends and relatives they never knew they had. This leads to charity, bad investments, and outright fraud.

*Handle it.* The sheer responsibility of having to deal with wealth could become burdensome. If the players are faced with the prospect of dealing with their wealth as businessmen, the accounting work might make them decide to chuck it all.

*Back-fix it.* Create an after-the-fact condition. Perhaps the dragon cursed his hoard to make it unusable after his death. The gold may disintegrate in time, it may prove to be *fool's gold* (especially after being spent, leading to angry mobs), or it may simply bring misfortune to its owners. I don't like to invent after-the-fact safeguards; it's sloppy, but it may be necessary.

Here are some methods that I *did* use to divest my players of their gold:

*Tax it.* The players considered this the same as stealing it. The local king took 10% as taxes, which replenished the war-depleted kingdom, but didn't really affect the characters that much. Some forms of taxing I didn't use were tithes to the local churches (another 10%, easily) or "finder's taxes." Since the gold was originally stolen by the dragon, the kingdom could claim at least 50% of the treasure as a finder's tax, to put the money back into the economy.

*Sacrifice it.* I invented a method of destroying gold which made the PCs want to do so. One character's land contained a tower he wanted to claim — but in the tower's basement was a demon of enormous power, held by a device powered by the destruction of gold. To destroy the demon itself required a deposit of about 4,000 tons of gold placed in the device. With some help from the king, the PCs destroyed the demon and gained the tower, probably saving the world as well. This left them about 250,000 gp each, plus their lands and castles.

*Use it.* The king had given the PCs land and made them barons, with the understanding that they would build strongholds and defend the land — which just happened to be in a hazardous area the king could not afford to protect. Another 3,000,000 gp was eventually spent here. More could have been spent if the characters were allowed to support large armies and build vast fortifications. Of course, that could easily have led to the problem of too much manpower.

### Make characters take chances

If the players enjoy having their characters hire "monster fodder" to do all dirty work, there are ways to discourage this. If they like to have NPCs test potions, draw swords, and press buttons, make sure the NPCs now and then find devices like magic swords that grant wishes to the *first* to draw them. Create potions that have a good effect on the first sip, then turn poisonous or cursed. Make traps that blast everything

around them, sparing only the person activating them. The key is to keep the PCs the DM and is certainly allowable, if the PCs are not totally spared such dangers.

Another deterrent to using "trap-testers" is taken from the old *Empire of the Petal Throne* game. If characters constantly have NPCs check for danger, the NPCs will lose respect for their masters and quite possibly rebel. Worse (if the characters value their reputations) is what would happen if word got out that someone else is doing the PCs' dirty work. The characters will lose face in public and eventually be branded as cowards. For characters with high positions (or the desire for them), this can be disastrous, especially if a disgraced character is (or was) a charismatic leader.

Of course, people may volunteer for such dangerous duty or they may do it to earn a living (like royal food-tasters). This is up to the DM and is certainly allowable, as long as the characters are not totally spared such dangers.

If a character controls an army, he will almost certainly want to take "a few of the boys" along on an adventure. Sometimes this is fine and even necessary, but it becomes annoying when too many "boys" come along. Adventures designed for a small group of characters become boring with an army going through them. Even 0-level soldiers can be a pain to referee, if there are enough of them.

Armies are meant to fight armies. If the characters insist on taking an army, give them an army to fight! Armies also have certain inherent disadvantages in a dungeon situation. They cannot move quietly (without a lot of magic), they're hard to hide, and they're difficult to fit into rooms. Even fifty men will easily fill a typical dungeon corridor.

In general, clever opponents are harder for a group to deal with than a straight-up, combat-type monster. Even weak monsters can be a menace with organization and strategy.

As a final tip on control, everyone who makes waves gets noticed by someone. The bigger the wave, the more people notice. The top gun in a group is always a target. A character of mine is a personal foe of many Sons of Set, as well as a few demon princes. To date he has always been triumphant, but he knows that someday, eventually, they may get him.

Once more, for emphasis: Any campaign can be controlled, or brought back under control if something has gone awry. Usually, the time and effort involved in re-controlling a campaign will still be less than it would require to scrap everything but the world map and start over. You may decide to create a new campaign at one or more junctures during your DMing career, and that's fine; there's nothing wrong with starting fresh, whatever the reason. But if you're doing it because you feel you *have* to, then it'd be a good idea to examine some other alternatives first, such as the ones outlined here.

## DUNGEON™ Adventures

(From page 20)

acters find a way into GAMMA WORLD®, STAR FRONTIERS®, or TOP SECRET® game settings. This can lead to horrible problems in campaign balancing. Characters from the AD&D game may enter other magical areas with different physical laws, but these should be independent of other game systems.

### Specific formats

Tables should be constructed so they are independent of the text. This lets us shift them around as needed to fit the pages available. For large tables, we can use scribing (lines) or screening (shaded areas) to make the table more readable.

Use numerals and spell out inches, feet, yards, etc., to indicate depth, height, length, and width. Hyphenate adjectival forms before nouns (e.g., the 10'-tall, red-haired hill giant). Use quotation marks to indicate inches when referring to scale inches. Use an apostrophe to indicate feet and quotation marks to indicate real inches only in very technical contexts. Be clear as to whether inches are scale inches or real inches.

Single-digit numbers (zero through nine) are spelled out. Larger numbers are written as numerals. Never start a sentence with numerals.

Abbreviations of D&D and AD&D terms usually use all capital letters and no periods (DM, NPC, HD). The abbreviations for hit points and for coins use lowercase letters (hp, gp, sp).

Numerals are used to identify character levels (e.g., 4th level, not fourth level). When preceding a noun, a level should be hyphenated (e.g., 2nd-level illusionist, the illusionist is 2nd level).

The names of magical items should be

underlined in the module you submit; they will be written in italic type in the final text. Capital letters are used only if the name of the magical item includes a proper noun. All plusses are listed after the description of the item. Because the format for magical items varies slightly according to the item's type, typical examples are given here: a *broadsword +1*, *chainmail +2*, a *potion of healing*, a magic-user scroll with *dispel magic* and *Tenser's floating disc*, a *ring of protection +2*, and the *Wand of Orcus*.

The abbreviations for gold piece, silver piece, copper piece, etc., have no periods (cp, sp, ep, gp, pp). Any amount of money over 999 should have a comma separating the thousands from the hundreds. A space should be left between the amount of treasure and the coin abbreviation (e.g., 1,500 gp).

List jewels in order of descending value. If there is more than one with the same value, note how many there are in parentheses after the value. Example: There are five gems in the sack, values 500 gp, 400 gp, 300 gp (x 2) and 50 gp.

When AD&D monster encounters are described in text, the listing should use the following format: monster name (AC #; MV #"; HD #; hp #; #AT #; Dmg #-#/#-#; other notes). For example: three ghouls (AC 6; MV 9"; HD 2; hp 10, 7, 5; #AT 3; Dmg 1-3/1-3/1-6; SA paralyzation) and Lars Longtooth (AC 2; MV 9"; F8; hp 52; #AT 3/2 at +2; Dmg 1-8 + 2; S 17, 19, W 10, D 16, C 15, Ch 13; *longsword +1*, *chainmail +2* and shield, longbow). Note the use of an abbreviated class and level in the latter example.

When D&D monster encounters are described in text, the listing should use the following format: monster name (AC #; HD #; hp #; #AT #; Dmg #-#; MV # "; Save #; ML #; AL \_). For example: one orc (AC 6; HD 1; hp 6; #AT 1; Dmg 1-6;

Save: F1; ML 8; AL C).

If more than one monster of a type is encountered, separate the individual monster's statistics by commas. The AD&D format in this case would look like this: three treants (AC 0; MV 12"; HD 7, 9, 12; hp 35, 40, 48; #AT 2; Dmg 2-16/2-16, 3-18/3-18, 4-24/4-24; SA animate trees; SD never surprised).

The names of spells or spell-like effects are italicized when they appear in the final text, and should be underlined in your module submission. The names of spells always are written in lowercase type. Capital letters are used only if the spell name includes a proper noun. Spell levels are written out (third level, not 3rd level).

Note that a *character* is a false personality created for the game. A *player* is someone who plays the game. Do not confuse the two in your text.

### Playtesting submissions

We recommend the module be playtested before completing a final draft. Playtester comments, good and bad, should be written down during play as they occur. Problems should be thrashed out after the session; it is important to keep the game going.

The best testing is done by an inexperienced DM and group who try to play from the manuscript without help. The designer should be present taking notes, but should not help the testers over the rough spots. There is no better way to find the holes in your design. Experienced players are a good way to find rule inconsistencies, but they may gloss over really basic aspects of play or assume local house rules or playing styles, thereby missing some problems. The least efficient method of testing is for the designer to run it. A designer tends to mentally fill in the design holes, especially with regard to games mechanics and encounter staging.



# Microscopic monsters

## When they get bigger, they get a lot tougher

by Kent Colbath

---

After several years of serving as a Dungeon Master, you may notice a certain sameness creeping into the routine parts of your adventures. As the characters advance toward whatever new twisted beast you've created to guard the latest fabulous treasure, they generally blunder through the standard assortment of orcs, giant rats, and zombies. Granted that for higher-level characters these may be replaced by ogres, wolves, and ghouls (or even telephone sanitizers, middle-level managers, and IRS agents if the DM is really sadistic), the effect is much the same. Where is a DM to turn for information on new lower-level creatures to inhabit his fantasy landscape?

One productive source of new monsters may be literally found underfoot. Single-celled plants and animals have a variety of bizarre properties which are ideally suited to the AD&D® game. Many of these creatures also have the virtue of living in water, a habitat which is particularly neglected in the available monster collections.

There are two ways to bring these monsters into play. The first is to shrink the characters to a very small size by magical means. Note that the characters must shrink to a fraction of an inch before a single-celled creature becomes much of a threat. This requires a shrinking spell of exceptional power.

The second, and I think more interesting, way to bring the monsters into play is by enlarging them (this is assumed in the descriptions given below). A high-powered *enlarge* spell cast on murky pond water would do the trick. More systematic enlargement of the cells might be undertaken by a powerful magic-user, human or otherwise, who would use the cells for some purpose.

### PROTISTON

One creation I've developed that may serve to introduce giant single-celled beasts to a campaign is Protiston, who may or may not exist at the option of the DM. Protiston is giant slime mold, a type of creature (described below) which alternates between being a swarm of individual amoebae and a colony that looks like a large, distorted mushroom. Each individual amoebal cell carries a certain amount of information, so Protiston functions much like a very slow computer.

Protiston (as it was named by the mage who discovered it) began as a simple collection of single-celled creatures in a large body of water, such as a sea or an ocean. At some some point in the distant past, Protiston became so large and complex that it acquired intelligence, and slowly thereafter gained magical skills. Being of such an alien intelligence, Protiston has no understanding at all of "normal" human thought, and regards everything around it as either a food source or "hostile environment" to be overcome and destroyed. No one knows for sure, but the chaotic evil alignment detected from Protiston may stem from either Protiston's innate disregard for all other forms of life, or from some form of association with the demon prince Juiblex (which might explain how Protiston gained spell-casting abilities). Little else is known of this being's origins or intent, save that it wishes to "eat" the entire world or shape it to benefit itself. Few beings are even aware that this creature exists — and few who have found it have lived to tell about it later.

As presently constituted, Protiston inhabits the interior of a large coral atoll (or a calm, shoreline cavern, if placed in an inland sea by the DM). Numerous support colonies of amoebae may be found around it. Although a single thought in Protiston's "mind" may take anywhere from a few seconds to a few weeks to complete, Protiston is highly intelligent and has gained the powers of a 12th-level

magic-user, being able to cast spells like *push*, *shield*, *continual darkness/light*, *ray of enfeeblement*, *stinking cloud* (above water), *hold person*, *protection from normal missiles*, *slow*, *hallucinatory terrain*, *plant growth*, *cloudkill* (above water), *hold monster*, *telekinesis*, *transmute rock to mud*, and *control weather*. Other spells may be possible, but no spell will be used that involves fire or that considers other beings to be intelligent (such as *charm* spells). Select Protiston's spells as if it were the only intelligent being around, and everything it might encounter was a mindless food source or part of the environment.

In addition to spell-casting abilities, Protiston is somehow able to magically or biologically increase the size of single-celled creatures, using these creatures as guards and helpers. Note that among these creatures, only Protiston is evil. The others are all neutral and unintelligent, and work to Protiston's advantage only according to circumstances.

There are many more ways to bring these creatures into play, and literally thousands of variations on the creatures described below. They are clearly not suitable for all adventures. You should find, however, that confronting your veteran characters with giant dinoflagellates, or amoebae that swarm together into a huge, gelatinous "slug," will quickly bring the characters to attention and prod them into resuming their quest with renewed vigor.

### DINOFLAGELLATES

The dinoflagellates are a very peculiar group of one-celled organisms which are generally classified with the plants. Most of them are capable of engulfing food particles, however, and some have completely lost their brown pigment and survive only by scavenging or predation.

Among the things which unite the group, one of the most striking is the presence of two thin whiplike organs, or flagella. One rings the central body of the organism like a belt, and is equipped with numerous tiny hairs which beat constantly. The other is long and slender, extending far beyond the organism's posterior, and beats in a wavelike motion. The combined action of the flagella causes the cell to spin on its axis while moving rapidly through the water.

In many members of the group, reproduction is triggered by an environmental change (generally a decrease in nutrients, light intensity, or temperature). The swimming cells pair off, fuse, and form spiny, thick-walled cysts that settle to the bottom of whatever body of water they inhabit. After an appropriate period of dormancy (generally a few months, but as much as a few years), environmental changes of the opposite sort will trigger the release of the cysts' contents, which then grow flagella, begin dividing, and start the life cycle anew. A clever (and powerful) magic-user could exploit this life cycle by artificially inducing cyst formation (using a cold- or darkness-causing spell, for example). In the cyst stage, the cells can be removed from the water and transported for considerable distances. Three of the four types of dinoflagellates listed here form cysts (Peridinium, Ceratium, and Gonyaulax).

Another interesting property of some dinoflagellates is bioluminescence. They give off light which is concentrated into a brilliant flash, used to startle potential predators (and, in this context, unwary adventurers). One cell is capable of producing a flash every 5-10 melee rounds. Peridinium, Gonyaulax, and Noctiluca all are capable of producing such flashes, with those produced by Noctiluca being particularly potent.

## Peridinium

	<i>Small</i>	<i>Medium</i>	<i>Large</i>
FREQUENCY:	<i>Common</i>	<i>Uncommon</i>	<i>Very rare</i>
NO. APP.:	2-12	1-6	1-2
ARMOR CLASS:	7	5	2
MOVE:	12"	12"	16"
HIT DICE:	1	2-3	5-8
% IN LAIR:	0	0	0
TREAS. TYPE:	<i>Nil</i>	<i>Nil</i>	<i>See below</i>
NO. ATT.:	1-3	1-6	2-8
DAM/ATT.:	1-4	1-4	1-4
SPEC. ATT.:	<i>See below</i>	<i>See below</i>	<i>See below</i>
SPEC. DEF.:	<i>Flash</i>	<i>Flash</i>	<i>Flash</i>
MAGIC RES.:	<i>Standard</i>	<i>Standard</i>	<i>Standard</i>
INTELLIGENCE:	<i>Non-</i>	<i>Non-</i>	<i>Non-</i>
ALIGNMENT:	<i>Neutral</i>	<i>Neutral</i>	<i>Neutral</i>
SIZE:	<i>S</i>	<i>M</i>	<i>L</i>
PSIONIC ABIL.:	<i>Nil</i>	<i>Nil</i>	<i>Nil</i>

Peridinium is a type of armored dinoflagellate covered with thick plates. Only the region from which the flagella arise is not covered, and should be treated as AC 9 (note that the rotation of the cell makes it difficult to aim at this particular spot, so the armor classes given above must be used).

Small pores extend through the individual plates. Within each pore is a single trichocyst, a projectile which for present purposes

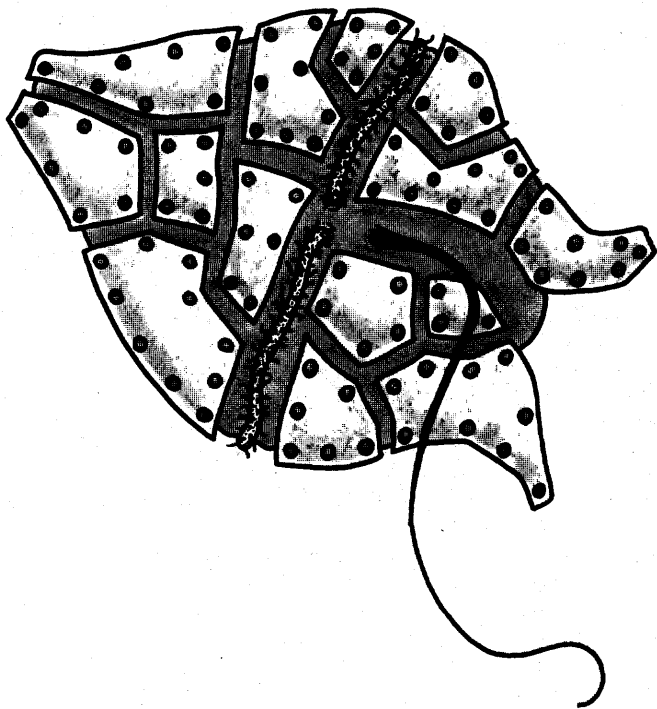

can be treated like a crossbow bolt. Although each pore has but a single projectile (these are replaced by new growth within a few hours), the rotation of the cell as it swims through the water constantly brings new pores into the line of fire. Small cells can fire up to 40 trichocysts, treated like light crossbow bolts with close range up to 10', medium 11-20', and long 21-30'. Medium-sized cells have 60 trichocysts (ranges 0-15', 16-30', and 31-45', while the largest forms can have more than 100 trichocysts (ranges 0-30', 31-60', and 61-90').

Peridinium may produce its flash response as other creatures approach, but will definitely flash when struck. A character within 10' of the cell must make a saving throw vs. spells or be blinded for 2-7 rounds, in addition to dropping any weapons in hand unless an

additional saving throw vs. breath weapon (with dexterity bonuses) is made. Characters 10-30' from the cell who fail their saving throw are startled for one round (no attacks allowed), and must also save again (same throw) to see if their weapons are dropped. For medium-sized cells, the saving throw has a penalty of -1, for large cells -2.

The cells occur in both salt and fresh water, and are most common in relatively clear water in the tropics. They survive primarily by photosynthesis, and will eventually die (or form cysts) if kept in the dark.

Legend has it that Protiston keeps unknown treasures within a large Peridinium, which swims in an elaborate pattern through the water of the lair, making the precise location of the treasure very difficult for "food sources" (adventurers) to discover. For added protection, eight medium-sized Peridinium swim in formation around the treasure cell, with swarms of small Peridinium and Ceratium around as well.

## Gonyaulax

FREQUENCY:	<i>Uncommon</i>
NO. APPEARING:	1000-4000
ARMOR CLASS:	7
MOVE:	12"
HIT DICE:	1
% IN LAIR:	0
TREASURE TYPE:	<i>Nil</i>
NO. OF ATTACKS:	0
DAMAGE/ATTACK:	0
SPECIAL ATTACKS:	<i>Nil</i>
SPECIAL DEFENSES:	<i>Flash, paralytic toxin</i>
MAGIC RES.:	<i>Standard</i>
INTELLIGENCE:	<i>Non-</i>
ALIGNMENT:	<i>Neutral</i>
SIZE:	<i>S</i>
PSIONIC ABILITY:	<i>Nil</i>

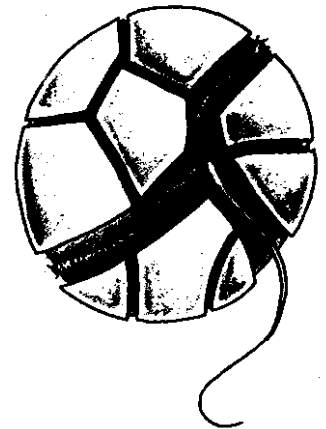

The cells of Gonyaulax look similar to those of a small Peridinium, and are roughly the size of a basketball. They are not equipped with trichocysts (for game purposes), but are capable of a flash defense like that of a small Peridinium. As individuals they are relatively harmless, but in large blooms (any group of 1000 or more) they secrete enough toxin to kill water-breathing creatures that cannot escape, and will eventually deplete the oxygen in a given small body of water. The toxin causes paralysis of all muscles (including lungs and heart) if the victim does not save against it. Because the poison is so weak, it a saving throw of 2 is sufficient against it — but the save must be repeated every round, and a roll of 1, regardless of any other circumstances, is enough to cause death by drowning to helpless victims in one round.

Gonyaulax occurs in both fresh and salt water, but toxic blooms are confined to salt-water areas to which large quantities of nutrients have recently been added.

## Ceratium

FREQUENCY:	<i>Common</i>
NO. APPEARING:	2-12
ARMOR CLASS:	6
MOVE:	15"
HIT DICE:	1-2
% IN LAIR:	0
TREASURE TYPE:	<i>Nil</i>
NO. OF ATTACKS:	1
DAMAGE/ATTACK:	2-5
SPECIAL ATTACKS:	<i>Nil</i>
SPECIAL DEFENSES:	<i>Nil</i>
MAGIC RES.:	<i>Standard</i>
INTELLIGENCE:	<i>Non-</i>
ALIGNMENT:	<i>Neutral</i>
SIZE:	<i>S</i>
PSIONIC ABILITY:	<i>Nil</i>

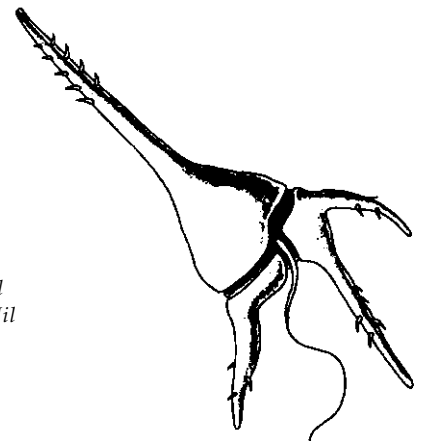



# The Quest is Over.

At last, you have found the mighty source for authentic Fantasy-Wear apparel. The Fantasy-Wear line comes alive with all new high quality screen printed designs on a selection of durable, heavy-weight T-Shirts and sweatshirts. Order your Fantasy-Wear T-Shirt or sweatshirt now while supplies last. Finally, it is your chance to wear the mark of fantasy and adventure.

## FANTASY-WEAR ORDER FORM

PRINT OR TYPE ALL INFORMATION BELOW

Name \_\_\_\_\_

Address \_\_\_\_\_

City \_\_\_\_\_ State \_\_\_\_\_

Zip \_\_\_\_\_ Phone \_\_\_\_\_

Method of payment (check one)  Check  Money Order  
 Visa  Mastercard **DO NOT SEND CASH**

CREDIT CARD NUMBER \_\_\_\_\_ EXP. DATE \_\_\_\_\_

Signature (as shown on credit card) \_\_\_\_\_

Fill out your completed order. Indicate size and quantity of garments desired.  
 Check and Money Order made payable to:

**Fantasy-Wear, P.O. Box 1443, Waukesha, WI 53187-1443**

Offer good only in U.S. Allow 4-6 weeks for delivery.  
 Only original order form or photo copy of form will be accepted.

**PLEASE DOUBLE CHECK YOUR ORDER TO AVOID DELAY. THANK YOU.**

GARMENTS PRINTED BY HOLORIEK, INC.

ADVANCED DUNGEONS & DRAGONS, DUNGEONS & DRAGONS, DRAGON, and DRAGONLANCE are trademarks owned by and used under license from TSR, Inc. ©1985 TSR, Inc. All rights reserved.

Description	Price	Indicate quantity in the appropriate boxes				Total
		Small	Medium	Large	X-Large	
Dungeons & Dragons® white sweatshirt 50/50 Poly cotton	\$14.95	92400	92401	92402	92403	\$
Dungeons & Dragons® 100% cotton white T-shirt (not pictured)	\$ 9.95	92404	92405	92406	92407	\$
Dragon® Magazine 100% cotton grey T-shirt	\$ 8.95	92408	92409	92410	92411	\$
Advanced Dungeons & Dragons® white sweatshirt 50/50 poly cotton	\$14.95	92412	92413	92414	92415	\$
Advanced Dungeons & Dragons® 100% cotton yellow T-shirt (not pictured)	\$ 9.95	92416	92417	92418	92419	\$
DragonLance™ 100% cotton light blue T-shirt	\$ 9.95	92420	92421	92422	92423	\$
Subtotal						\$
5% Wisconsin State Tax (Wisconsin residents only)						\$
Shipping/Handling						\$2.00
Total						\$



Ceratium is an armored dinoflagellate with an extended point ornamented with sharp ridges. It attacks with its point, while the rotation of the cell causes the point to twist much like a drill. The twisting motion is highly effective at penetrating armor lighter than chain mail (+2 to hit vs. AC 6 on up to AC 10). In contrast, this "drill" is relatively easy to deflect by a shield held at an angle to the attack, and thus attacks at a -3 to hit against all shield-using opponents. These two modifiers are cumulative. Ceratium will easily slash through nets on a roll of 1-5 (d6). These cells occur in both fresh and salt water.

#### Noctiluca

FREQUENCY: *Rare*  
 NO. APPEARING: 2-10  
 ARMOR CLASS: 8  
 MOVE: 9"  
 HIT DICE: 2-5  
 % IN LAIR: 0  
 TREASURE TYPE: *Nil*  
 NO. OF ATTACKS: 1  
 DAMAGE/ATTACK: *See below*  
 SPECIAL ATTACKS: *Nil*  
 SPECIAL DEFENSES: *Flash*  
 MAGIC RES.: *Standard*  
 INTELLIGENCE: *Non-*  
 ALIGNMENT: *Neutral*  
 SIZE: *M*  
 PSIONIC ABILITY: *Nil*

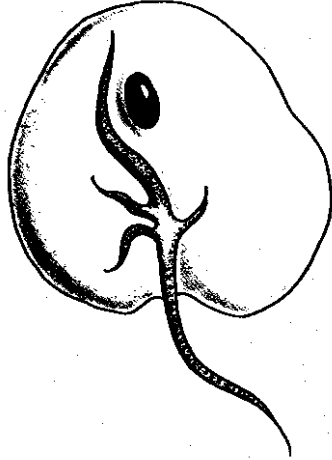

Unlike the other dinoflagellates listed above, Noctiluca is not armored. It is incapable of photosynthesis, and survives by capturing other organisms with its tentacle and ingesting them. The tentacle will not damage an adventurer, unless it wraps around his throat (roll of 1 on d8), in which case it does 2-7 hp damage. Once ingested (which takes 3-5 rounds), a character suffers 1-3 hp damage per round until rescued or slam.

Noctiluca has a very potent flash, capable of blinding a character within 20' for 5-15 rounds unless a saving throw vs. spells is made at -3. A blinded character will automatically drop any weapons in hand. A character making the saving throw will be startled for one round, and must save vs. breath weapon (with dexterity bonuses) or drop his weapons. At a range of 20-80', a failure to save vs. spells (at -2) will produce a two-round startle response, with an additional throw against dropping weapons. Note that any characters which have been ingested will also be affected by any flashes made.

This cell is able to grasp a heavily armored character (AC 5 or better) with its tentacle on a roll of 13, lightly armored characters (AC 6 to AC 8) on a roll of 14, and those without armor on a roll of 15. Shields place a -1 penalty on these attacks, but the cell attacks blinded characters at an additional +3 to hit, and startled characters at +2.

Noctiluca has only one very small flagellum, and moves by flailing its tentacle or grasping the bottom. It has a large eye spot and is able to detect changes in light and dark. It is only found in salt water, most commonly in the tropics.

#### EUGLENOIDS

The euglenoids are another group of single-celled organisms which may have pigment for photosynthesis, or may be colorless and survive by engulfing particles. The pigment, if present, is green. They move by flailing a single long flagellum.

#### Euglena

FREQUENCY: *Common*  
 NO. APPEARING: 10-60  
 ARMOR CLASS: 9  
 MOVE: 12"  
 HIT DICE: 1  
 % IN LAIR: 0  
 TREASURE TYPE: *Nil*  
 NO. OF ATTACKS: 0  
 DAMAGE/ATTACK: 0  
 SPECIAL ATTACKS: *Nil*  
 SPECIAL DEFENSES: *Nil*  
 MAGIC RES.: *Standard*  
 INTELLIGENCE: *Non-*  
 ALIGNMENT: *Neutral*  
 SIZE: *S*  
 PSIONIC ABILITY: *Nil*

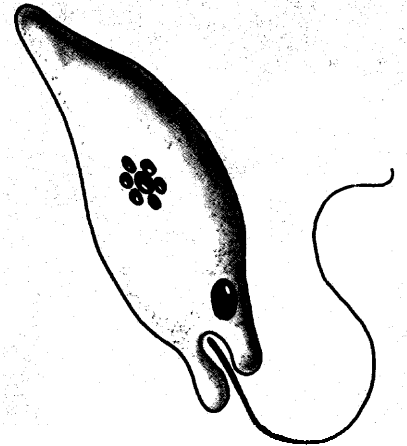

Cells of Euglena are oblong, 1'-3' in length. They are more annoying than dangerous, and are not capable of inflicting damage on a healthy character. They are attracted to light, and to food which has not been carefully wrapped. They will engulf food material up to about the size of a fist. An occasional Euglena will also ingest a coin or jewel.

Euglena is a favorite food source of larger water-dwelling creatures. Large swarms of Euglena will eventually attract attention, particularly if any of the cells are damaged.

Euglena is found in both fresh and salt water, and on damp ground. Protiston uses these cells as "food animals."

#### CILIATES

Ciliates are one-celled animals which are covered with tiny hairs, which they use for movement. They do not have pigment, but survive by ingesting food particles through a mouth-like groove. Although only one type is described here, they come in a variety of shapes and sizes.

#### Paramecium

FREQUENCY: *Uncommon*  
 NO. APPEARING: 3-18  
 ARMOR CLASS: 8  
 MOVE: 9"  
 HIT DICE: 1-2  
 % IN LAIR: 0  
 TREASURE TYPE: *Nil*  
 NO. OF ATTACKS: 1  
 DAM/ATT.: 1 hp every 2 rounds  
 SPECIAL ATTACKS: *Nil*  
 SPEC. DEF.: *Sticky threads*  
 MAGIC RES.: *Standard*  
 INTELLIGENCE: *Non-*  
 ALIGNMENT: *Neutral*  
 SIZE: *S-M*  
 PSIONIC ABILITY: *Nil*

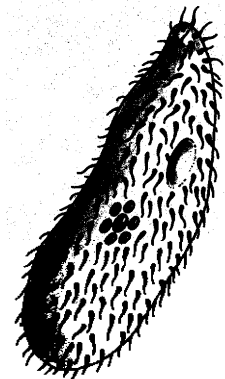

Like Euglena, Paramecium is more annoying than dangerous to a well-equipped dungeon adventurer. The cells are rarely more than 2-3' long, and thus cannot completely engulf a human. They may be able to "swallow" a hand or foot (attacks at -2), however, and in this case do 1 hp damage every second round after ingestion up to a maximum of 3 hp.

Sticky threads exuded by Paramecium are primarily used for defensive purposes, although they may be used to anchor the cell to

# New! MODULES FOR TWILIGHT: 2000

## Going Home

You just got the news: What remains of the American army in Europe has been ordered back to the States. But the news is old; after all, you're cut off behind enemy lines in central Poland. You have just three weeks to cross 700 miles of devastated country, past marauders and through the Red Army, to the German port of Bremerhaven, where the last ship for the USA is ready to leave. Your transportation: the only functional steam locomotive left in Poland.

In addition to the adventure, *Going Home* includes:

- ★ A full-color map of northern Germany that connects to the map in *Twilight: 2000*.
- ★ A referee's guide to the NATO and Pact units in their winter quarters as the year 2000 draws to a close.
- ★ A rundown on the French occupation of the Rhineland and their military activities in the "dead zone" east of the river.
- ★ Game specifications for the German Leopard III and British Challenger tanks. \$7.

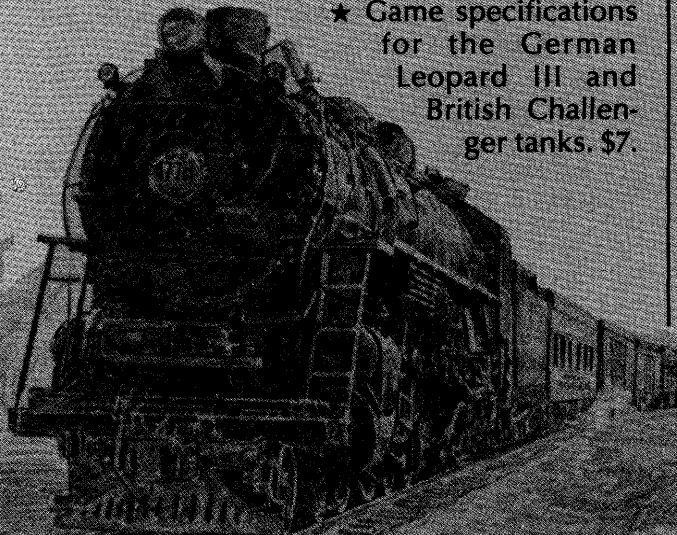

## U.S. Army Vehicle Guide

This supplement contains a complete listing, with full game information and ratings, of every type of combat vehicle (and representative support vehicles) in the U.S. service in the year 2000, including many vehicles not found in the basic game. There are a wealth of drawings and eight pages of color plates, plus U.S. order of battle as of July, 2000, with remaining manpower and armored vehicle strengths. *The U.S. Army Vehicle Guide* is an invaluable reference for *Twilight: 2000* referees and players. \$7.

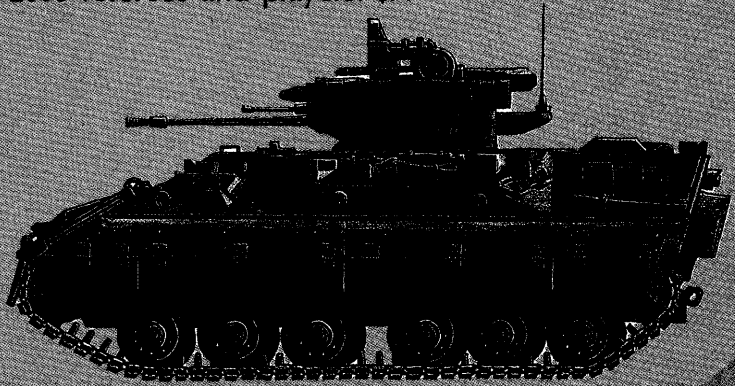

# Twilight: 2000

*Twilight: 2000*, \$18 (Add \$1 postage and handling). Many more modules available—send for free catalog.

**GDW** Game Designers' Workshop  
P.O. Box 1646  
Bloomington, Illinois 61702-1646

an intended victim. The threads are kept immediately below the cell wall, and can be extended to a maximum range of 5'. A hit upon Paramecium will automatically trigger the release of sticky threads whether or not the cell is destroyed. Edged weapons will get stuck on a successful roll of 17 or less, pointed or blunt weapons on a roll of 19 or less. Weapons wrapped in threads attack at -3. It requires 1-6 rounds of concentrated effort to free such weapons.

Paramecium is attracted to food particles, but unaffected by light. Damaged cells will attract larger animals. Paramecium is most common in fresh water lakes and ponds, but is also found in salt water.

### AMOEBAE

Amoebae are colorless single-celled organisms with a flexible cell wall. They move by extending lobes of cell material outward, releasing the surface beneath the cell body, and contracting the extended lobe. The lobes are also used to engulf small food particles, and are capable of dishing out chunks of larger food items – something partially decayed is best!

#### Amoeba

FREQUENCY: *Uncommon*  
 NO. APPEARING: 3-30  
 ARMOR CLASS: 10  
 MOVE: 6"  
 HIT DICE: 1-3  
 % IN LAIR: 0  
 TREASURE TYPE: *Nil*  
 NO. OF ATTACKS: 1  
 DAM/ATT.: 1-3 hp/round  
 SPECIAL ATTACKS: *Nil*  
 SPECIAL DEFENSES: *Nil*  
 MAGIC RES.: *Standard*  
 INTELLIGENCE: *Non-*  
 ALIGNMENT: *Neutral*  
 SIZE: *S-M*  
 PSIONIC ABILITY: *Nil*

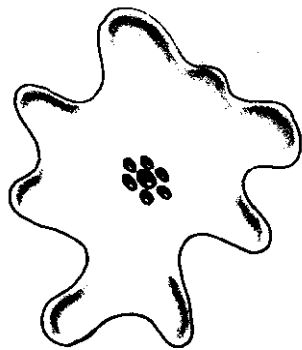

Cells of Amoeba range from 2'-5' in diameter, are relatively flat, and irregular in outline. Blunt weapons and missile weapons do half damage, unless they strike the nucleus (natural roll of 19-20). Edged and pointed weapons do normal damage, double if they strike the nucleus (characters must state that they are aiming for the nucleus to receive the bonus).

Once an Amoeba scores a hit, it remains attached to the character, doing 1 hp/round/HD damage as it engulfs hunks of flesh. Amoeba is highly sensitive to fire, and a torch will do 1-6 hp damage to it per round of application (no roll to hit necessary unless the character throws the torch).

Amoeba is a scavenger which is attracted to decaying organic material. It's found in areas with damp ground (forests and swamps), in ponds and lakes, and particularly in dank caverns.

### FORAMINIFERA

Foraminifera are marine relatives of the amoebae. They are encased in a chambered shell penetrated by pores. The lobes of cell material which they use for locomotion and capturing prey extend through the pores, and are thus long and stringy.

There are two basic types of foraminifera: those that dwell on the bottom and those that float. One example of each is given below.

#### Elphidium

FREQUENCY: *Uncommon*  
 NO. APPEARING: 5-20  
 ARMOR CLASS: 3-4  
 MOVE: 6"  
 HIT DICE: 1-3  
 % IN LAIR: 0  
 TREASURE TYPE: *Nil*  
 NO. OF ATTACKS: 3  
 DAMAGE/ATTACK: 1-3  
 SPECIAL ATTACKS: *Nil*  
 SPECIAL DEFENSES: *Nil*  
 MAGIC RES.: *Standard*  
 INTELLIGENCE: *Non-*  
 ALIGNMENT: *Neutral*  
 SIZE: *S-M*  
 PSIONIC ABILITY: *Nil*

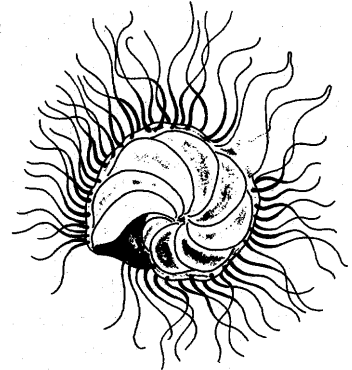

Elphidium is a bottom-dwelling form which ranges in size from 2' to 6' across. Large cells have more chambers and a higher armor class. Those with 1 HD do only 1 hp damage/attack, at 2 HD 1-2 hp, and at 3 HD 1-3 hp.

Elphidium moves much like Amoeba, and is also basically a scavenger. The threadlike nature of its lobes gives it a different mode of attack, however. The shell of the cell remains relatively stationary, while the threadlike lobes pull food particles back to it. Elphidium thus must roll for a hit with each new attack (three attacks per turn possible). The 10 and can be cut off after suffering any damage. The cell can grow new threads with ease, and only hits to the main body cause permanent damage. Because the threads easily penetrate the joints in heavy armor, all armor heavier than chain mail is treated as AC 5 for attack purposes.

These cells are found in sandy patches on the shallow sea floor, in both warm and cold oceans.

#### Globigerina

FREQUENCY: *Rare*  
 NO. APPEARING: 10-60  
 ARMOR CLASS: 5  
 MOVE: 0"  
 HIT DICE: 2  
 % IN LAIR: 0  
 TREASURE TYPE: *Nil*  
 NO. OF ATTACKS: 1/3  
 DAMAGE/ATTACK: 1-4/1-2  
 SPECIAL ATTACKS: *See below*  
 SPECIAL DEFENSES: *Nil*  
 MAGIC RES.: *Standard*  
 INTELLIGENCE: *Non-*  
 ALIGNMENT: *Neutral*  
 SIZE: *See below*  
 PSIONIC ABILITY: *Nil*

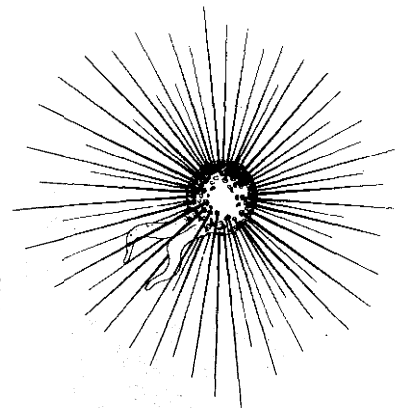

Globigerina is a floating form consisting of a relatively small central coiled shell (3' diameter) with long, slender, needle-sharp spines extending to a total diameter of 15'. A character attacking the cell with any weapon other than a long lance or a missile suffers 1-4 hp damage from the spines, never reaching the central shell, unless the spines are first broken away (a risky task itself).

The cell floats passively, waiting for prey to blunder into it. The sharp spines do an initial 1-4 hp damage, followed by an attack made by thread-like lobes of cell material. On a hit, this attack does 1-2 hp additional damage, and also causes the victim to become stuck among the spines and threads. Subsequent attacks on trapped prey (three per turn) are made at +2. To escape, a character must make a saving throw vs. paralyzation at -4.

Although Globigerina cannot actively swim, it can slowly sink or



# Summer 1986 Catalogue

The  
**Wizards  
Nook**®

Is Now Available  
featuring Original  
Fantasy Sculpture  
Art Prints &  
Posters

Send \$2.00

(and deduct it from your 1st order) Co.

Post Office Box 16085 Plantation Florida 33318



rise in the water column. When a group of cells is encountered, they will be arranged at a variety of depths, much like a field of floating mines. A field of Globigerina can be particularly deadly when encountered at night.

Globigerina is only found in salt water. It is generally restricted to fairly deep, open water, although occasionally one may drift into a harbor.

### SLIME MOLDS

These creatures are so bizarre that it seems as though they evolved specifically to be used in AD&D games. Slime molds are best considered a type of colonial amoeba, although they are commonly mistaken for mushrooms during one phase of their life cycle.

The numerous amoebae which make up a colony move independently, scavenging for food, until the food begins to run out. At that point they mass together forming a large communal gelatinous mass, which in some forms is capable of movement (and is appropriately called a "slug"). When a suitable site is located, the front third of the amoebae join together and form a stalked structure called a sporocarp.

As the sporocarp hardens, the amoebae forming it die. The remaining amoebae round up and form spores in the upper chamber. At this point, the sporocarp splits open, releasing the spores to blow or roll away. When a spore lands in a patch of damp ground, an amoeba hatches out, and the life cycle is repeated.

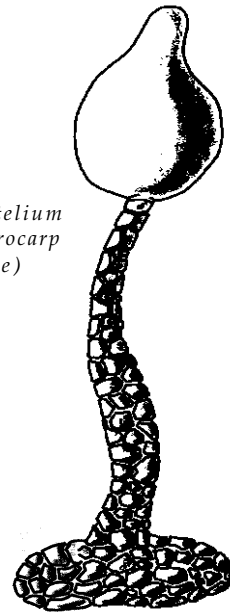

*Dictyostelium*  
(in sporocarp stage)

### Dictyostelium

	Amoeba	Slug	Sporocarp	Spore
FREQ.:	<i>Rare</i>	<i>Very rare</i>	<i>Very rare</i>	<i>Rare</i>
NO. APP.:	30-600	1	1	1-100
AC:	10	9	4	6
MOVE:	6"	9"	Nil	Nil
HIT DICE:	1-2 hp	30-600 hp	20-400 hp	1 hp
% IN LAIR:	0	0	0	0
TREASURE:	Nil	Nil	Nil	Nil
NO. ATT.:	1	See below	Nil	Nil
DAM/ATT.:	1	See below	Nil	Nil
SPEC. ATT.:	Nil	Nil	Nil	Nil
SPEC. DEF.:	Nil	Nil	Nil	Nil
MAGIC RES.:	Standard	Standard	Standard	Standard
INTEL.:	Non-	Non-	Non-	Non-
ALIGN.:	Neutral	Neutral	Neutral	Neutral
SIZE:	S	L	L	S
PSI. ABIL.:	Nil	Nil	Nil	Nil

In the amoeba stage, the cells should be treated like small members of Amoeba with 1-2 hp each. The slug is attracted to light, and otherwise acts much like a gelatinous cube without the paralytic ability. The slug is capable of engulfing one character per 15 hp, and will do 2-7 hp damage/round to each character engulfed. Torches do 1-6 hp damage to the slug attacking at +4. Blunt weapons and

missiles do half damage. If the slug is severely damaged (15 hp in one round) it will simply break up into individual amoebae.

Dictyostelium will not attack in the sporocarp stage. In the early stages of its development, the sporocarp is covered with damp mucus, and fire attacks do only half damage. At maturity the sporocarp is dry, and fire attacks are much more effective. If the sporocarp is not completely destroyed in one attack, however, most of the spores will be ejected. Sharp blows to the stalk or cap may also cause release of the spores.

The spores are small (1-2' in diameter) and relatively light. They are easily destroyed by direct application of fire, and blunt weapons attack them at +1 doing normal damage.



A single spore which escapes destruction is capable of producing an entirely new colony. By dividing once every six hours, for example, an amoeba hatched by one spore would generate a colony of 256 amoebae after just two days. The rate of division will vary based on the amount of food available, and will always slow down as the colony becomes very large.

Dictyostelium is most common in humid forests, and is only rarely found in dungeons.

Protiston should be regarded as an advanced form of Dictyostelium, having maximum hit points at any stage. About 30 colonies of Dictyostelium make up the whole of Protiston, and each is scattered up to 300' apart across several caves or atolls. The power of Protiston's magic may vary from place to place, depending on the number of colonies in the area, but would be powerful in the sporocarp stage. Protiston may be considered psionic as well (developed as the DM wishes).

## STATE OF WAR

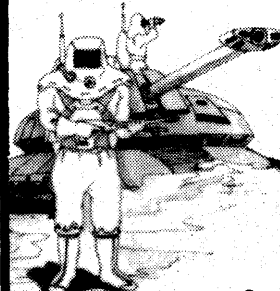
The year is 2000! They said it would never happen again. BUT IT HAS!!!  
CIVIL WAR IN THE U.S.!!!

After years of foreign wars and inept leadership, twenty states attempt SECESSION in this newest Play-By-Mail game from the PBM leader, Game Systems Inc. As the GOVERNOR of the state of your choice, you must order the recruitment and placement of troops, allocate expenditures for training, industrial expansion and scientific research, and still try to keep your populace happy! With GSI's NEW "Phase" system, players can give from 50 to 100 orders per turn and receive combat results on MULTIPLE BATTLES per turn! Add this to GSI's reputation for accurate results and prompt turnaround times and you have the BEST PBM GAME EVER!!! A \$15.00 registration fee includes rules, 3-color map and 2 FREE turns. Thereafter, turns are \$4.75 each, NO HIDDEN COSTS EVER!

Game Systems Inc. P.O. Box 431870 Miami, FL 33243-1870

## Guidelines

If you're interested in contributing an article to DRAGON® Magazine, the first thing you need is a copy of our guidelines for writers. Send a self-addressed, stamped envelope to "Writer's guidelines." c/o DRAGON Magazine: P.O. Box 110, Lake Geneva WI 53147; and we'll send you back a sheet with all the basic information you need to make sure your manuscript has the best possible chance of being accepted.

# The role of books

## Fiction with a flavor that gamers will savor

Reviews by John C. Bunnell

---

### **MAGIC KINGDOM FOR SALE — SOLD!**

Terry Brooks

Del Rey 0-345-31757-2 \$16.95

There may be hints of Piers Anthony's Xanth and of L. Frank Baum's Oz in Terry Brooks's newest novel, but one thing is quite certain: Once and for all, Brooks has proven that he is more than an imitator of J. R. R. Tolkien. More importantly, he has proven that he is a thoroughly competent storyteller in his own right.

*Magic Kingdom For Sale — Sold!* does present an outline similar to a long line of quest novels and RPG campaigns. The story is of Landover, a realm caught in centuries of neglect and badly in need of rescuing. Into this situation comes Ben Holiday, a once-sharp Chicago lawyer trying to escape the memory of the death of his wife. He now owns Landover, having bought the country from a respected mail-order catalog for a tidy \$1 million. At least, he thinks he owns it.

Himself an attorney, Brooks has carved out a series of plot twists and complications well suited to his protagonist's skills. In part, Holiday's task is one of diplomacy and negotiation, while other aspects of his assignment call for shrewd detective work and deduction. The stakes, however, are higher than those of a normal lawsuit — the Iron Mark, demon lord of Abaddon, waits to challenge Holiday's claim to Landover's throne.

As the jacket promises, the novel contains equal parts of magic, mystery, and adventure. What isn't advertised is that, in Ben Holiday, Brooks has at last created a hero with whom readers can empathize and interact. Most of the lesser characters are also appealing, especially Questor Thews, a "bumbling wizard" who has unexpectedly divided loyalties. These are well-drawn characters, and their presence is a welcome surprise.

One major irritant, however, is held over from Brooks's Shannara novels. An air of pretentious self-confidence still hangs over the climactic revelation. Where Charles de Lint, for instance, springs the truth on readers with real surprise, Brooks persistently claims they should have known it all along.

But even this bad stylistic habit can't keep *Magic Kingdom For Sale — Sold!* from being a consistently lively tale that is easily the author's best work to date. Landover is a worthy invention, and its restora-

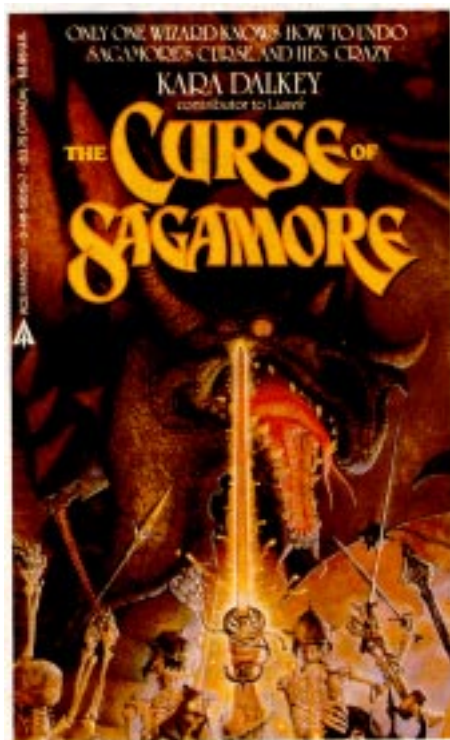

tion is a worthy challenge. (Now there's an idea for a campaign!)

### **THE CURSE OF SAGAMORE**

Kara Dalkey

Ace 0-441-12619-7 \$2.95

Curses in the AD&D® game are normally considered rather low-level magic, obvious in their effects and relatively easy to dispel. By contrast, the hero of Kara Dalkey's first novel spends much of the book trying to learn exactly what his curse does — and that's just the first of Prince Abderian's problems.

It doesn't help that Sagamore, Abderian's great-grandfather and the curse's originator, was a talented court jester before he received the throne of Euthymia from a king dissatisfied with his blood heirs. Sagamore's reign and those after it have been a complex muddle of natural disaster, political chaos, and practical joking.

Abderian's curse takes the form of a peculiar magical mark on his right arm. To many, this mark of Sagamore gives him the right to succeed his father as king, which itself is a serious liability. To begin with, Abderian doesn't really want the throne. Yet he remains a target for would-be assassins and for the leaders of rival cults hoping

to control the kingdom through him.

Dalkey's humor is sometimes broad, sometimes sly, and always on the mark. Abderian is a likeable protagonist, and the assorted wizards, conspirators, and supernatural beings are agreeably devious and scatterbrained as the occasion demands. Dalkey also has a welcome talent for springing unexpectedly logical plot twists at precisely the right moments, among them the true whereabouts of Prince Paralian (Abderian's older brother) and the fate of the royal family displaced by Sagamore.

In short, not only is *The Curse of Sagamore* almost certain to produce a solid afternoon's worth of highly amusing adventure, it should also give gamers lots of ideas for curses and annoyances with which to bedevil a campaign.

### **YONDER COMES THE OTHER END OF TIME**

Suzette Haden Elgin

DAW 0-88677-110-2 \$2.95

Any gamer who has ever tried to reconcile the principles and effects of magic with those of psionics knows that the task is a sticky one at best. Yet *Yonder Comes the Other End of Time* not only tackles the problem, it also tries to connect two distinct sets of Suzette Haden Elgin's previously published novels. The result, not surprisingly, is an exceedingly complicated tale that raises more questions than it answers.

It begins when Coyote Jones, highly placed agent of the Tri-Galactic Intelligence Service, is assigned to track down the source of a most peculiar unidentified telepathic signal. Not only is the mysterious broadcast coming from an invisible planet, but it also consists of grammatical symbols that have been obsolete for nearly a thousand years.

Jones, however, is mind-deaf, one of the few individuals in the Three Galaxies who cannot perceive mental projections. He is, therefore, able to see through the planet's invisibility, but that doesn't stop him from being thoroughly surprised when he wakes up from a crash landing to discover that he has arrived on a world where magic works.

That world, of course, is the planet Ozark, scene of Elgin's Ozark fantasy trilogy. Its citizens are descendants of a spaceship-load of Appalachian colonists who deliberately isolated themselves from Earth centuries past, and they have remained true to their agrarian heritage since. Despite



Jones's best efforts to recruit Ozark as a Federation member (the Federation would dearly love to acquire some of the Ozarkers' magical skills), the planet's citizens stubbornly refuse to join.

The contrast between Tri-Galactic "psience" and Ozarker magic is intriguingly drawn, and Elgin's story moves at a satisfying pace. But Coyote Jones and Ozark's Responsible of Brightwater have both been protagonists in their separate adventures, and setting them against each other makes for an unsettling conflict in which neither really wins.

On one level, that's the stuff of good literature — and there are a number of hints and suggestions that Elgin knows exactly what she is doing with the social issues she raises. Those issues, plus at least one glaring loose end involving a smuggled Bible, virtually demand a sequel.

But on another level, fans of the earlier Jones and Ozark tales may have a right to feel a bit cheated. Both series have been praised as clever and humorous adventures in a lighter vein, and while this newest book keeps to the same general tone, it is very definitely trying to be something slightly different. Elgin's intentions may be good, but it may take another book before her readers are convinced that the shift in mood is justified.

## WITCH BLOOD

Will Shetterly

Ace 0-441-89644-8 \$2.95

According to the new *Oriental Adventures* rules for the AD&D® game, martial artists (better known as monks) don't belong in traditional Western-style campaigns. Though it's probably true that monks lit best in Oriental surroundings, one need only read *Witch Blood* to learn that they can be highly effective in the more familiar worlds of medieval fantasy as well.

As a young boy, Rifkin is chosen by wandering disciples of the Warrior Saint to learn the disciplines and skills of the martial arts. This involves lengthy schooling in a lonely mountain retreat, and the descriptions both of this place and the craft it teaches mark Rifkin as a monk of no small ability. The main story, however, is set in a crumbling castle that is home to a besieged band of outcast witches, and echoes strongly of eastern Europe.

Not surprisingly, Rifkin is himself a wanderer, and it is by accident that he enters the valley of Castle Gromandiel. His martial powers enable him to defeat the huge bear that serves as one of the witches' guardians, and in return for the slaying Rifkin agrees to serve Naiji, the castle's mistress.

From that point on, *Witch Blood* piles mystery upon intrigue. There are spies among the castle staff and ninja-like master assassins in the woodwork. More prosaic political struggles pit Count Talivane Gromandiel against a neighboring duke, and eventually find the castle literally under

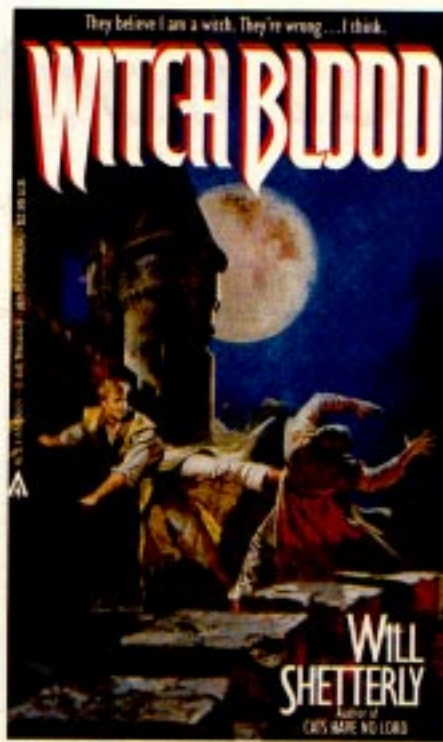

siege. Stranger yet, Rifkin displays an inexplicable affinity for magic that only explains itself when a part of his past unexpectedly catches up with him.

Though Rifkin is usually a strong defender of honor, he is far from being pure of mind and not above devious maneuvering when it suits his purpose. Will Shetterly does a dextrously detailed job of sketching Rifkin's personality and provides a sharp-eyed but ascetic tone to the narration that perfectly understates the dark atmosphere of the tale. The prose style is markedly different from Shetterly's previous novel, *Cats Have No Lord*, demonstrating versatility as well as substantial talent. Only in the very last line does he slip slightly out of character, and then only to foreshadow a sequel.

For the promise of another story about Rifkin Wanderer, that moment of flippancy is easily forgiven.

## THE CROSS-TIME ENGINEER

Leo Frankowski

Del Rey 0-345-32762-4 \$2.95

A healthy percentage of AD&D® gamers raise strenuous objections to any introduction of technology or advanced science into the medieval setting of the game. While the world of *The Cross-Time Engineer* lacks the counterbalancing element of magic, it still offers skeptical players and referees a well-reasoned response to those objections, and does so with a remarkable style combined with a touch of cheerful irony.

Leo Frankowski's novel (the first of four) uses a familiar premise: Conrad Schwartz, a near-future engineer on a hiking trip, is accidentally thrown backward to a pre-technological time. But there are numerous twists in the concept, all important to the novel's development. Conrad is Polish, and conveniently lands in Poland in the year

1231 — just ten years before the country is due to be wiped out by a Mongol invasion. Trapped in the thirteenth century, he decides to do the patriotic thing: industrialize Poland and prepare to thwart the Mongols. And just to make matters more interesting, Conrad is a confirmed socialist.

To add a hint of mystery to this otherwise straightforward scenario, Frankowski adds occasional interludes to the story in which observers from Conrad's time comment on his progress. Though they provide Conrad with the means to begin his campaign, their roles aren't fully defined. Clearly, future volumes will twist in unexpected directions.

Frankowski's prose is smooth and wryly humorous, and his research has clearly been thorough. Aside from the potential time-travel paradoxes, the plot holds few surprises, but that isn't really a valid criticism. Rarely has unabashedly historical science fiction been this much fun, and readers should be eager to collect future books and find out whether Conrad really can get a live-hundred-year start on the industrial revolution.

## THE UNICORN QUEST

John Lee

Tor 0-812-54400-5 \$2.95

The title of this novel is an accurate (if rather abbreviated) description of its contents, which, in a year overrun with books about dragons, initially sounds like a promising change from the norm. Unfortunately, too much of John Lee's tale is vague and rambling, and the parts that aren't owe entirely too much to certain of the dragon stories.

There has been a war going on for a very long time in the Strand — a war between kingdoms whose civilization is based on magic and mysterious alien Others with awesome technological weapons. Indeed, it appears that the Others may finally win unless two young people (one an aspiring mage, the other the daughter of a noble house) can manage to fulfill a prophecy uttered out of the blue.

It might have been a successful plot. But the war takes place almost entirely offstage so that there is very little sense of tension or of a genuine threat, and the basis of the conflict — revealed at the very end of the book — has nothing to do either with unicorns or with the human civilization, for the most part. As for the protagonists Jarrod and Marianna, Lee sets up the expected romance almost at once, then puts it on hold for the sake of the old convention about unicorns favoring virgins — only to set it back on track again late in the novel.

Odder still, Lee gives the unicorns very little to do beyond standing around and looking impressive. Though they do possess magical power needed to combat the Others, their mere presence is apparently enough to turn the tide. And Lee's unicorns have both telepathic powers and the ability to teleport through something called Interim — abilities that give them an

**Hey Gamers! Don't throw away those used 02-900 All Things Dark and Dangerous cards once you've removed the figures from them! Ral Partha's going to have a great new promotional offer coming soon, and those used cards will come in very handy.**

The **Chronicles of Romanni the Wanderer** tell a frightening story of brewing unrest in the fantasy world. The lurking forces of evil are ready to the attack with renewed vigor, the weapons of magic and steel honed to razor sharpness! It's the rumblings of the **Chaos Wars™**—confusion seeking to make its masterpiece, with the beleaguered (but determined) forces of Light and Good prepared to make their stand.

Hear the beginning of the story whenever you send in for your FREE Chaos Wars™ stickers! For a stamped, self-addressed envelope, you get five of our red-hot Chaos Wars™ logo stickers, and a brief introduction to the story.

Follow the progress of the Chaos Wars™ with a subscription to the War Bulletin! For five bucks, you get five big issues of interesting character sketches, campaign suggestions, artifact descriptions and many, many other features. It's guaranteed to add to your fantasy universe immeasurably.



Romanni the Wanderer.

Wear the uniform of the Chaos Wars!™ The official Chaos Wars™ T-shirt is now available for \$6.00. It's brilliant red, with dramatic artwork and two very chaotic quotes on the front - what the well-dressed minion of the Black Prince will wear!

Attention, Ral Partha Imports Fans! After September, we are going to be replacing several of our older Ral Partha imports lines to make room for new and more exciting lines to come. So now's the time to order any of these figures you need to complete your armies or fill out your collections! Included will be any Fantasy Tribe Goblins (FTG's), Gnomes (FTN's), and Dwarves (FTD's), as well as some selections from other lines. Call or write for complete details - and stock up now!

## DRAGONS.

Here are three recent additions to Ral Partha's selection of fantasy dragons. In keeping with the Ral Partha tradition, these dragons are imaginative, elegantly sculpted, easy to assemble and paint — and fun!

**The Guardian Dragon.** A two-headed dragon, ideally suited to the task of defending a key dungeon passage, a hoard of gold, or a magic door. One head sleeps while the other maintains the vigil; at the first sign of a challenge, both heads rise to the attack!  
**10-210 Guardian Dragon (7 pieces) . 8.00**

**The Silver Dragon.** Supremely intelligent, well-versed in magic spells and ancient lore, this aesthetically-minded creature would prefer not to be disturbed by the machinations of the fantasy world. He is a devastating force, however, when he doesn't get his wish.  
**10-211 Silver Dragon (5 pieces) . . . . 8.00**

**The Forest Dragon.** Even a creature as mighty as a dragon can be transformed by too many years spent in the twilight beneath the forest canopy. Nevertheless, the Forest Dragon's low-slung body and scurrying gait take nothing away from its badger-like toughness and power in a fight!  
**01-146 Forest Dragon . . . . . 8.00**

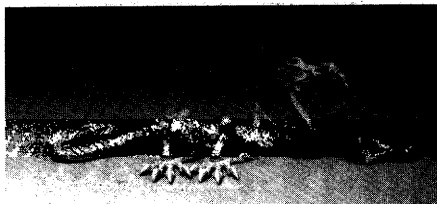

10-210



10-211

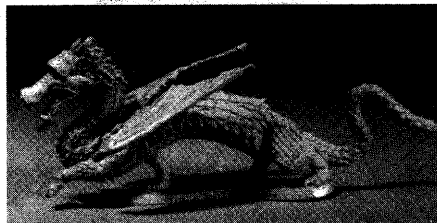

01-146

# BUSHIDO™

## MINIATURES

From Ral Partha Enterprises

It's an alternative fantasy world, and yet in a way, it actually existed — it's the beautiful, mystical world of Japanese history and legend. And it's represented in the role-playing game BUSHIDO™ from Fantasy Games Unlimited.

Ral Partha Enterprises presents the only officially-licensed BUSHIDO™ figures available anywhere. You know they'll be exciting and brilliantly detailed, because they're sculpted by Bob Charrette; you know they'll fit the game perfectly, because Bob is one of the BUSHIDO™ co-designers.

<b>53-901</b>	Samurai and Ronin (3 figures)	3.50
<b>53-902</b>	Samurai Bushi (3 figures. Comes with a selection of 6 different crests)	3.50
<b>53-903</b>	Ninja (3)	3.50
<b>53-904</b>	Budoka and Yakuza (3)	3.50
<b>53-905</b>	Female Adventurers (Samurai Bushi, Shugenja, and Buddhist Gakusho)	3.50
<b>53-906</b>	Gakusho Priest and 2 Shugenja Magicians	3.50
<b>53-907</b>	Tengu (3)	4.00
<b>53-908</b>	Oni Demons (2)	3.00
<b>53-909</b>	Kappa (3)	3.50
<b>53-910</b>	Shikome (3)	3.50
<b>53-911</b>	Dai-Bakemono (1 figure, with assorted weapons)	4.00
<b>53-912</b>	Dai-Oni (1 figure, may be assembled holding sword or naginata)	4.50



53-901

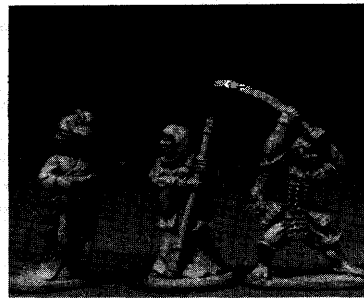

53-905

## The Assassin.

In the beginning, he's just like any other young man of ambition looking to get ahead in the world. Except that he doesn't have quite the physical strength to be a fighter, nor does he possess the intellect necessary to master the intricacies of magic use. He finds that there is wealth to be gained nevertheless - by sticking a knife in the appropriate back.

From his furtive, lean beginnings, the assassin moves up in his trade, until ultimately he is a Master assassin - the best of the cutthroats, a deadly and expensive weapon, to be used against only the highest-placed and most influential targets.

**3-Stage Characters.** Sculpted by Tom Meier. Each character comes in 3 versions, representing three successive stages of his development. Watch your character become larger, wealthier, better-armed!

<b>01-315</b>	Fighter	3.50
<b>01-316</b>	Ranger	3.50
<b>01-317</b>	Magic User	3.50
<b>01-318</b>	Hobbit Thief	3.50
<b>01-319</b>	Elf Thief	3.50
<b>01-320</b>	Paladin	3.50
<b>01-321</b>	Human Assassin	3.50
<b>01-322</b>	Barbarian Fighter	3.50
<b>01-323</b>	Dwarf Fighter	3.50
<b>01-324</b>	Elf Fighter	3.50
<b>01-325</b>	Druid	3.50
<b>01-326</b>	Cleric	3.50

... And introducing the four newest 3-Stage Characters:

<b>01-327</b>	Anti-Paladin	3.50
<b>01-328</b>	Elven Fighter/Magic-User	3.50
<b>01-329</b>	Fighter with axe	3.50
<b>01-330</b>	Illusionist	3.50

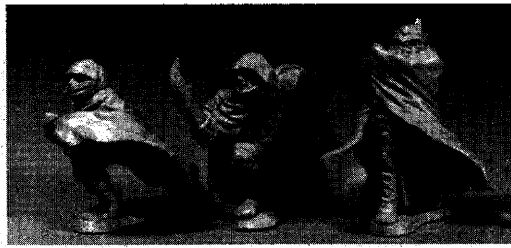

# RAL PARTHA ENTERPRISES

5938 Carthage Court • Cincinnati, Ohio 45212  
TOLL FREE 1 (800) 543-0272 • In Ohio, (513) 631-7335

Use this ad as a handy order form! Or as a checklist to keep track of which figures you've bought, and which one you still need.

For more information on the Chaos Wars™ T-Shirt offer, new releases, or anything else mentioned here, please feel free to call us TOLL FREE during Eastern Standard Time business hours.

**COMPLETE LISTINGS** of all Ral Partha's thousands of fantasy figures are contained in the **1986 Fantasy Catalog**. Send for yours today! It costs \$2.00, but comes with a handy Redemption Coupon good for \$2.00 off your first order.

**MAIL ORDERS:** For mail orders under \$30.00, please add \$2.00 postage and handling. Orders \$30.00 and over are postpaid. Sorry, we can't accept C.O.D. orders!

uncomfortably close resemblance to Anne McCaffrey's Pernese dragons.

What's more frustrating about all this is that Lee's writing isn't actively bad, only undistinguished. Given a tougher plot or more memorable characters, *The Unicorn Quest* could have been a passable adventure. As it stands, however, the novel's best recommendation is that it isn't about dragons, and that's not enough to lift it above its neighbors on the bookstore shelves.

### INTERSTELLAR PIG

William Sleator

Bantam Spectra 0-553-25564-9 \$2.95

According to Barney's summer neighbors at the beach, "Interstellar Pig" is a brand-new science-fiction game about to hit the retail market. The object? To capture and hold the Pig at the end of the game, when only its possessor and his or her homeworld will survive while the rest of the universe goes up in smoke. And Barney's neighbors just happen to have an advance copy. . . .

Barney's neighbors also happen to be a little strange. They show unusual interest in the house his parents have rented for the summer — it's said to be haunted, and a madman is supposed to have been locked in Barney's bedroom for twenty years. (The stories began after an unexplained shipwreck occurred in the ocean beyond a nearby island.) They also seem too relaxed

to be members of the wealthy jet set, as they claim.

It takes Barney some snooping next door, a bit of detective work, and a sailboat trip to the island to figure out just how strange the neighbors are. On the island, he finds the real Interstellar Pig and rapidly becomes involved in a deadly high-stakes contest against aliens who want the Piggy for themselves.

The Piggy then tells Barney it has the "hiccup," and the game's rules seem to change. Each hiccup equals a 100-megaton nuclear blast so that only the Piggy's owner dies at game's end. Which explanation of the game is right? Barney must decide, with Earth's future riding on his choice.

William Sleator expertly juggles several levels of conflict in *Interstellar Pig* and creates at least three fascinating games along the way. There are elements of board games, role-playing games, and tactical wargames in the various sets of rules, and readers following Barney's adventures will almost certainly wish that at least one version really was on the market. They may also begin to realize, however, that the aura of ruthlessness coloring many real science-fiction and fantasy games loses some of its attractiveness when it's extrapolated into reality.

That makes the novel a valuable lesson in perspective as well as a fast-paced tale of alien invasion. And that makes *Interstellar Pig* doubly rewarding.

### RECURRING ROLES

*The Hounds of God* (Bluejay, \$15.95) brings Judith Tarr's trilogy about an elven healer and wizard to a powerful climax. As a singlework, it's a fast-moving blend of magic, intrigue, and deadly danger. The series as a whole, however, may be one of the few epic adventures of recent years with real literary merit lurking behind the fireworks.

Less ambitious, but nearly as absorbing, is *Dervish Daughter* (Tor, \$2.95), Sheri Tepper's second novel in the third True Game trilogy. This will send fans of these tales scurrying to reread the previous books, as odds and ends long since disposed of begin to rearrange themselves in preparation for a climax of major proportions in the final volume.

M. Coleman Easton, meanwhile, has turned to the East with *Iskiir* (Questar, \$3.50), the story of a sorcerer's nephew who alone may be able to save a might city from destruction. As with *Masters of Glass*, the magic is intriguing, but the execution occasionally falters.

It may be wise to reread the short story in DRAGON® Magazine issue #100 before tackling *Artifact of Evil* (TSR, \$3.95), the second of Gary Gygax's novels about Gord of Greyhawk. Unlike its predecessor, this one doesn't have space for a travelogue. The action is constant, and the plot machinations are almost complicated enough to warrant keeping a scorecard.

**SF-19**

**SF-14**

**SF-17**

# NEW RELEASES!

## Survival Force on Cycles!

<b>SF-13 Road Warriors</b> (Chopper w/2 riders & 2 foot figures)	<b>\$4.50</b>
<b>SF-14 Dirt Bike w/Rider</b>	<b>\$2.50</b>
<b>SF-15 Cycle Gang</b> (Chopper w/2 riders)	<b>\$3.00</b>
<b>SF-16 Gigantous on Chopper</b>	<b>\$2.50</b>
<b>SF-17 Female Chopper Pilot</b>	<b>\$2.50</b>
<b>SF-18 Weapons Pack</b>	<b>\$1.50</b>
<b>SF-19 Death Squad (3 figs.)</b>	<b>\$3.00</b>

**Order all (5) Motorcycle Sets and receive Weapons Pack FREE!!**

**Order from:**

## Castle Creations

2413 N. High St.  
Columbus, OH 43202

Send \$1.00 for new catalogue

## FINALLY. JAPANESE ROBOT COMBAT THAT'S REALLY JAPANESE ROBOT COMBAT.

You can settle for "Armored Combat" games, where the robots are pre-generated and have all the thrill and excitement of walking tanks. Or you can play MEKTON. Complete build-it-yourself for ANY kind of robot. A simple, easy to use battle system, with all the action you're looking for. And a complete ROLEPLAYING system to give your "mecha" combat the dimension of realism. MEKTON: so much like the real thing, you'll think you were in a cartoon. Ask for it at your nearest hobby or game store.

## MEKTON™

R. TALSORIAN GAMES, INC.,  
Box 2288, Aptos, CA 95001-2288



# RECON® is Back! And Palladium Books Has It!

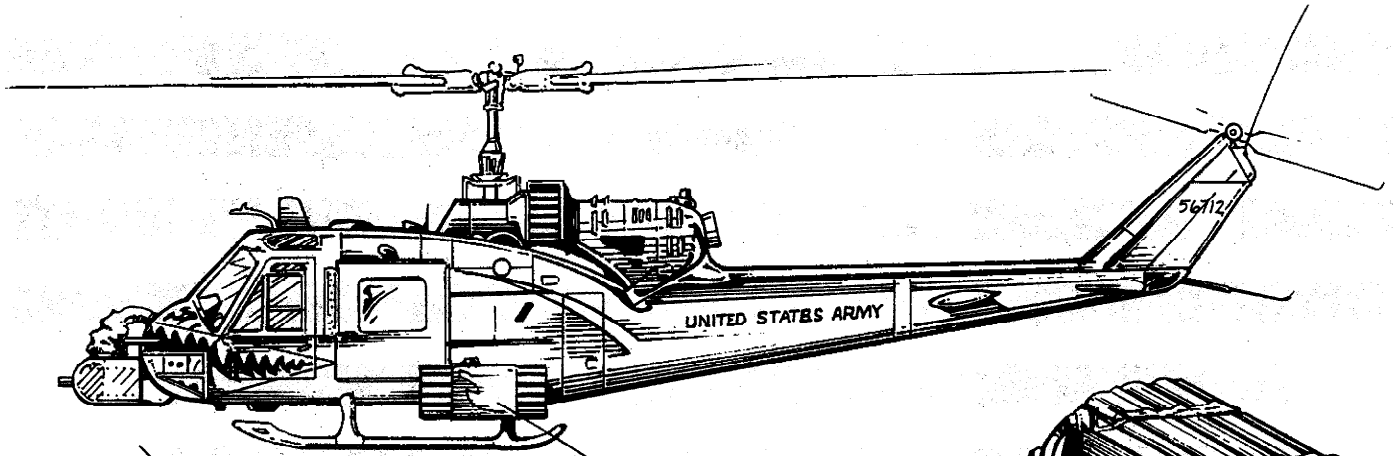

M5 BOW-MOUNTED  
40mm GRENADE LAUNCHER

XM3 ROCKET LAUNCHER

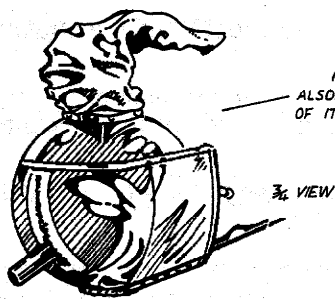

M5 40mm GRENADE LAUNCHER  
ALSO CALLED "THUMPER" AS A RESULT  
OF ITS DISTINCTIVE SOUND.

3/4 VIEW

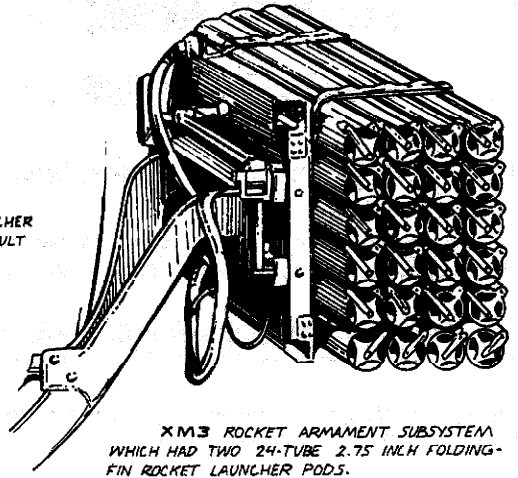

XM3 ROCKET ARMAMENT SUBSYSTEM  
WHICH HAD TWO 24-TUBE 2.75 INCH FOLDING-  
FIN ROCKET LAUNCHER PODS.  
THE UH-1B AND UH-1C HELICOPTERS  
COULD BOTH USE THIS DIRECT FIRE AREA WEAPON.

## The Revised RECON®

RECON is the first and only role-playing game of modern warfare. It is a game system designed for quick playability and to simulate the kind of counterinsurgency warfare fought in the Vietnam War. Players assume characters of elite Recon teams to penetrate enemy lines on missions of rescue, intelligence, espionage and sabotage. Although the game's focus is Vietnam, players are not limited to the 1970's or Southeast Asia.

Expanded rules allow players to play contemporary mercenaries or military specialists that can span the world. An extensive hardware section includes helicopters, small arms, heavy weapons, booby traps, artillery, patrol boats, tanks and other vehicles.

### Highlights Include . . .

- Revised rules for role-playing.
- The original miniature RPG rules (optional).
- Special Rules for compatibility with *Heroes Unlimited*®, *TMNT*™ and the well known Palladium game system.
- Helicopter and Modern Weapons combat rules.
- Expanded weapons section including US and Soviet weapons and vehicles. ALL illustrated.
- Booby Traps and Tunnel Rats.
- The contemporary mercenary!
- Nearly a dozen NEW adventure scenarios.
- \$14.95 (post paid)

Palladium Books®  
Dept. D  
5926 Lonyo  
Detroit, Michigan 48210

Please allow 6 to 8 weeks for delivery.  
All checks and money orders must be in US funds only.

THE PALLADIUM BOOK OF CONTEMPORARY WEAPONS contains over 300 hand-held weapons from around the world. Included are revolvers, pistols, sub-machine guns, machine guns, rifles and various attachments. Each weapon is illustrated, with many detailed cut-away diagrams, pertinent information and notes of interest. \$5.95 (post paid).

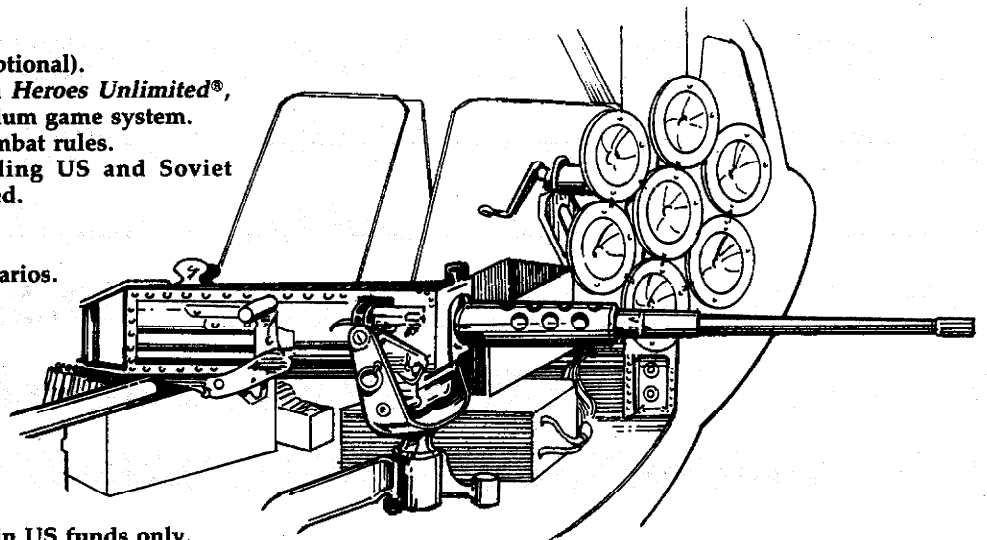

# Are you missing

## a DRAGON<sup>®</sup> magazine

# in your lair?



Well, a limited number of back issues of DRAGON<sup>®</sup> Magazine is available through The Mail Order Hobby Shop. Or, if you've been searching in vain for that special article that appeared in the now out-of-print issues of DRAGON Magazine, our Best Of DRAGON<sup>®</sup> volumes might fill your need.

Just take a look at the list below, then check the lines of those issues you'd like to order. If you want more than one copy of a specific issue, write the number of copies on that issue's line.

These offerings are priced at \$3.00 each (except for all issues after #105, which cost \$3.50, and the Best of DRAGON<sup>®</sup> anthologies); payment in U.S. funds **only**. Be sure to add shipping and handling charges. Then, complete and mail the order form below.

(Please PRINT all information plainly)

Name \_\_\_\_\_

Address\* \_\_\_\_\_

City \_\_\_\_\_

State/Prov. \_\_\_\_\_ Zip \_\_\_\_\_

Country \_\_\_\_\_

Date \_\_\_\_\_

\* Please use street address, not a P.O. Box number.

**Check one to indicate your choice of payment**

- Check enclosed                       MasterCard\*  
 Money order enclosed               VISA\*

\* **Minimum credit card order: \$15.00 No exceptions, please.**

\_\_\_\_\_  
 Name to which credit card is issued

\_\_\_\_\_  
 Credit Card No.

\_\_\_\_\_  
 Expiration Date

\_\_\_\_\_  
 Signature of the person to whom credit card is issued

Allow four to six weeks for delivery.

DRAGON is a registered trademark owned by TSR, Inc.

© 1986 TSR, Inc. All Rights reserved.

### ISSUES AVAILABLE

DR111

- |        |        |         |
|--------|--------|---------|
| — # 71 | — # 89 | — # 99  |
| — # 73 | — # 90 | — # 101 |
| — # 74 | — # 91 | — # 102 |
| — # 76 | — # 92 | — # 103 |
| — # 79 | — # 93 | — # 104 |
| — # 81 | — # 94 | — # 105 |
| — # 82 | — # 95 | — # 106 |
| — # 84 | — # 96 | — # 107 |
| — # 86 | — # 97 | — # 108 |
| — # 87 | — # 98 | — # 109 |
| — # 88 |        | — # 110 |

### Best Of DRAGON<sup>®</sup> anthologies

- Volume I (\$3.95)
- Volume II (\$3.95)
- Volume III (\$3.95)
- Volume IV (\$4.50)
- Volume V (\$4.50)

Subtotal of all magazine costs	\$
Illinois & Wisconsin residents, add 5% sales tax	\$
Shipping & handling, regardless of number of magazines	\$ 4.50
<b>TOTAL AMOUNT DUE</b>	\$

**MAIL TO: The Mail Order Hobby Shop, P. O. Box 756, Lake Geneva WI 53147.  
 Make checks or money orders payable to: The Mail Order Hobby Shop.**

# Death of an Arch-Mage

Can the police solve the mystery in time?

Designed by Michael D. Selinker



*Death of an Arch-Mage* is a murder mystery in the form of an adventure for the AD&D® game: It is designed for players and Dungeon Masters who have an appreciation for such things. The game of murder weaves an intricate web that only the truly dedicated can untangle.

Successful use of a mystery adventure requires a good deal of atmosphere. The Dungeon Master must take pains to ensure that the adventure has the authenticity of a good murder-mystery novel. Special attention must be paid to two facets of the mystery: suspense and detail.

This adventure provides many opportunities for suspense, although actual combat is infrequent. The scenario has a prescribed time limit and an ongoing plot line that will

constantly change the nature and the availability of the information the player characters need to gather. Certain key effects are designed to heighten the suspense, such as a crossbow bolt that comes flying out of nowhere. This bolt will not hit a PC, but it will come *extremely* close to produce maximum heart-stopping excitement. Careful attention by the DM to opportunities for suspense is essential.

What this text cannot provide is all of the requisite detail that makes a mystery novel entertaining. Therefore, it is incumbent upon the DM to be able to provide any detail the characters need. The DM should also be able to spontaneously generate useless information, and convey it in a way that does not make it seem useless. Certain

"clues" in the module are worthless for purposes of solving the mystery, but the DM should do his best to ensure that as much attention is paid to them as to the actual clues.

At the same time, the DM must be exceedingly stingy with information, releasing a fact only when it is asked for and not giving away anything that the investigator does not deserve to find out. The characters should not be handed the solution to the mystery on a silver platter. These seemingly contradictory concepts of abundance vs. conservation of detail can be summarized in one sentence:

*The Dungeon Master must have at his fingertips every detail the characters will never receive.*



## THE MODULE

Use of this module requires more than a casual reading. The DM must be thoroughly familiar with all sections of the scenario before play begins, because he will need to draw from all areas of the text constantly and simultaneously. In a murder mystery, hesitation on the part of the Dungeon Master is reprehensible; error is criminal.

*Death of an Arch-Mage* is designed for tournament play, although it can easily be adapted for campaign play (see below). In tournament play, players should be given the tournament characters provided herein, as well as copies of the mansion maps and the Kelburn law sheet, before play begins. *An examination of the tournament player* characters will reveal that one of them (the commander of the group) is a spell-casting ranger, while the other three are humans with two classes. Each of these three has 2nd-level fighter ability and 8th-level ability in one of the other main classes (magic-user, cleric, thief).

Regardless of whether the adventure is played as a tournament or in a campaign setting, a strict time limit must be enforced. When the mystery begins to unfold, game time passes at the same rate as real time: The PCs — and the players — have *four hours* to solve the mystery before the adventure ends. Refer to the section entitled “The end” to find out what will happen when the time limit expires.

The most important feature of the adventure is the plot line. A continuous chain of events will occur as the PCs carry on their investigation, and these events will have dramatic effects on the evidence the characters gain. To maintain close control of the plot line, the DM should time the adventure with a stopwatch, referring to the plot line about every five minutes to discover the latest events that have occurred or are about to occur. It is recommended that the DM photocopy the maps provided with this module, giving one set (or more) to the players and keeping a set for himself to use as “location maps,” employing miniature figures or other markers to indicate the whereabouts of the NPCs as well as the player characters. These location maps, of course, should only be viewed by the DM.

The suspects are detailed below, in a section of their own. Several of them are likely to be questioned by the PCs at different points during the adventure. Should this occur, the suspects’ stories and their answers to key questions are given for the DM to refer to. Of course, none of the NPCs will just give out information at the drop of a hat; they will probably have to be convinced that the PCs are doing their best to find the killer(s) and will try to give out only information that will direct suspicion away from themselves.

Several documents have been reproduced in this package of information. When a document is discovered by the PCs, the DM should reveal the appropriate piece of paper. The documents may be photocopied, but if

this is done the DM should make sure that the two double-sided documents are faithfully reproduced,

If this module is used as part of a campaign, players should be able to use their existing characters. A party of three to seven characters should be sufficient, with no player representing more than one PC. No character should be higher than 9th level, and the average experience level of the party should be no lower than 8th unless five or more characters are used, in which case an average level of 7th is acceptable.

In campaign play, characters should be forbidden from using certain spells and types of magic — specifically *raise dead*, *resurrection*, *speak with dead*, *contact other plane*, and *commune* spells, and any magic items that duplicate or simulate these functions. All other spells and magic items are fair game; however, some of the capabilities available to player characters may be illegal according to the laws of Kelburn. Nothing prevents the characters from breaking these laws, but if they do so they run the risk of having the results of their investigation nullified; as in our world, a criminal may be able to go free if the evidence against him was collected by illegal means.

In campaign play, the PCs must somehow be set up as Kelburn police officers; perhaps they have been hired for this special assignment, but are not normally attached to the department. In addition to forbidding them the use of the spells and magic items described above, the DM should try to avoid allowing campaign PCs the use of weapons, armor, or equipment that is not appropriate to the mission at hand or that is not permissible according to the laws of Kelburn. In general, the closer the PCs conform to the abilities and characteristics of the tournament characters, the more exciting and fulfilling the adventure will be.

## THE LAWS OF KELBURN

The legal code of the city of Kelburn is severe. A person brought to trial and found guilty of committing or contributing to murder is usually sentenced to life imprisonment or sometimes death, depending on the nature of the crime. However, Kelburn’s code regarding civil rights is equally strict, and police officers are bound by the guidelines enumerated below.

1. Police officers may not take sentient life except in self-defense, and then only if no other means are available to protect the safety and welfare of the officer.

2. Unnecessary violence in the apprehension of a suspected criminal is prohibited. Violence may be employed only if no other means are available.

3. Protection of any innocent persons takes precedence over the apprehension of a suspected or known criminal.

4. Police officers may not detain a person not officially charged with a crime for any length of time, and may not prohibit a person from undertaking normal activities unless the person is officially charged with a

crime.

5. The interrogation of a person not officially charged with a crime is prohibited unless that person consents to being questioned.

6. Police officers do not have the power of search and seizure except as regards the property and persons of dead victims of crimes, or when an officer is searching for or confiscating evidence to be used in the prosecution of officially charged subjects.

7. Police officers may not employ psionic powers, detection magics, and other such forms of divination except on a person who has been officially charged with a crime.

8. It is illegal for an officer to officially charge a person with a crime without specific knowledge or possession of unimpeachable, substantial evidence or the voluntary confession of the person in question.

Any violations of the above laws will void a case in the eyes of the Kelburn courts and render any other evidence inadmissible. Should such a violation be determined to have occurred, any charged suspect is automatically absolved of any charges and the offending officer(s) may be dismissed from the force and/or punished to the full extent of Kelburn law.

## THE BEGINNING

Alexonus Romdril, arch-mage and former mayor of Kelburn, has requested a security team from the city’s police force to attend a gathering at his country mansion beginning on Oct. 19, 1353. Although he is out of office at the present time, Romdril’s political pull is still quite strong. He intends to bring together dignitaries from Kelburn and its rival city Jonholm for a session of deliberation and negotiation in hopes of lessening or removing some of the sources of tension between the cities. Your special detective team has been given the architectural plans to Romdril’s mansion and assigned to the case.

As you ride along the path through the miles of forest between Kelburn and the mansion, you think back on the years when Romdril was the mayor of the city. (Note to DM: In a campaign adventure, the following information will be received by PCs as part of their briefing before they leave the city.) Aided by his wife Liana and the magic-user guildmaster Sandar Fleatis, the arch-mage governed the city justly, never shirking his commitment to Kelburn. He reinforced Kelburn’s civil-rights codes, allowing the citizens unprecedented amounts of freedom. He also restructured Kelburn’s police force, integrating members of specialized classes into the ranks. This adventuring-party model led to a highly varied, extremely competent police battalion capable of handling most criminal and civil violations. Romdril’s tactics damaged the strength of Kelburn’s assassins’ guild, temporarily halting the war between the guilds of Kelburn and those of its sister city, Jonholm. Romdril fostered good relations between the two cities, and his effort was

occasionally supported and assisted by Alkus Alambar, the chief alchemist of Jonholm. Romdril's sixteen years as mayor brought new prosperity and security to the city of Kelburn.

Romdril's life came crashing down around him in the Kelburn mayoral election campaign of 1352. His wife Liana died unexpectedly on December 14, a scant eleven days before the election. Her death devastated the mayor, leaving him vulnerable to a political attack from his challenger, Orian Flaloch. Running on an anti-magical platform, Flaloch seized upon the arch-mage's grief as proof that he had lost his alleged magical dominance over the good citizens of Kelburn. Romdril succumbed to his tragedy, stopped campaigning, and virtually withdrew from public view, ensuring Flaloch's victory. Romdril retired to his country mansion and has been seen in the city on only very few occasions since then.

Flaloch's attempts to dismantle Romdril's legacy during the last few months have not met with much popular support. He has threatened to remove what he calls "demonwork" from the police force by dismissing all members with magical powers or items, but has not yet succeeded in persuading a majority of the city council to back him up on this. However, the police force has felt the pressure and has sharply curtailed its use of magic to avoid drawing undue attention to the issue. The new mayor has issued two edicts that are within his power to declare and enforce: He has cut off relations with Jonholm and declared the magic-users' guild in Kelburn to be illegal, although no action has been taken against the guild's members.

The lessened influence of the police department and the magic-users' guild has led to an upsurge in the influence of the Kelburn assassins' guild, suspected to be under the leadership of one Andre LeMeurtrier. The combination of all these events has caused a new breakout of conflict between the assassins' guilds of Kelburn and Jonholm – something that Flaloch does not encourage but by the same token has not taken steps to prevent. It is in this climate of turmoil and increasing despair that the police department received Romdril's request for manpower.

You reach the mansion at 7:00 p.m. on October 19 and are promptly led inside by Raleigh, Romdril's longtime manservant. Romdril appears calm and collected as he receives you, projecting a regal appearance in his arch-mage's robes. Romdril's mute bodyguard, Mok, stands stoically next to his master. He carries a heavy crossbow secured in a shoulder strap, a quiver of red-fletched quarrels slung over his other shoulder, and a great mace dangling from a loop at his belt.

Romdril greets you serenely, giving the impression of being a man at peace with himself. No trace of the sorrow and tragedy that tainted the mayoral election can be seen in his eyes or perceived in his de-

meanor. The arch-mage effusively welcomes you as "members of the finest police force in the world" and courteously asks for a report on the status of his cherished city. You briefly fill him in on the general state of affairs and he frowns slightly as the bad news reaches his ears, but then he suggests that maybe something will happen during this gathering to change the situation. He then bids you to sit nearby in the inner foyer and oversee the proceedings as his guests begin to arrive.

The first guest to enter is Sandar Fleatis, who was Romdril's apprentice in days long gone by. Romdril greets his former student with a smile, which is quickly reciprocated. Fleatis introduces himself to you, but there is really no need for introductions; you know that he has become one of Kelburn's most successful businessmen since the election. This fact presents an interesting paradox, because he is also well known as one of Orian Flaloch's most vociferous critics. He has taken this stance in part because of his personal attachment to Romdril and partially because of his position as leader of the magic-users' guild, an organization that Flaloch would gladly see disbanded. Though Fleatis is twenty years younger than Romdril, the brown-cloaked man speaks with the same amount of wisdom that his former master is renowned for.

The door chimes ring again momentarily, and Alkus Alambar is admitted to the mansion. The chief alchemist of Jonholm shoves his dress coat into Raleigh's arms as well as his old bones will allow. Alambar, more than eighty years old, is known for his gruff manner and sometimes violent temper, both of which seem to be in fine form tonight. The alchemist barely acknowledges his host with a grunt and goes off muttering into the inner foyer. There he begins to cough and wheeze, but soon arrests the problem by swallowing a small white pill that he has taken from a bottle in his pocket. Romdril and Fleatis exchange sidelong glances, as if they are concerned about the old alchemist's health. They certainly needn't worry about his wealth, however; Alambar's black, sigil-laden robes are expensive-looking – clear evidence of the fact that the alchemist is as rich, and probably as powerful, as his fellow arch-mage Romdril.

Once more the door chimes sound, and Orian Flaloch strides regally into the mansion. As usual, the mayor of Kelburn is traveling without a guard; he is fond of demonstrating that his faith is all he needs to protect himself from the "machinations of demons," as he puts it. Flaloch deftly tosses his ornate black jacket on a coat rack and smiles thinly when Romdril dispassionately welcomes him. Flaloch hands Romdril a small metal box, identifying it as "the documents you asked me to bring," and the arch-mage gives the box to Raleigh, instructing him to put it in the master bedroom for safekeeping. Romdril appears to remain at ease as the two enemies exchange small talk for a couple of moments, but Flaloch has difficulty at first hiding his

anxiety. Then the mayor regains his composure as he is introduced to your group, and he utters an off-hand remark about the motley composition of your team. Fleatis begins to issue a response just as Raleigh steps in to announce that dinner is ready. Everyone prepares to move toward the dining hall, and Raleigh takes the opportunity to announce that the meal and the service for his guests will be an out-of-the-ordinary treat; a special cook, named Mennek, and a highly recommended maid, Enni, have been contracted for the duration of their stay. The manservant adds that the servants are well regarded in their home city of Jonholm, where they have performed this sort of special service on several occasions. Abruptly, Raleigh is cut off in mid-sentence by a fourth chime of the doorbell.

From your position in the entranceway to the inner foyer, you can see Raleigh react visibly, and quite negatively, as he opens the door. Mok, his body planted firmly in the path between the front door and where his master stands, brings his crossbow to the ready with impossible speed as the alleged assassin Andre LeMeurtrier saunters into the foyer. Raleigh grabs the man's arm to stop his advance and states firmly that LeMeurtrier was not invited and is certainly not welcome here. Just then, Romdril claps Mok on the shoulder in reassurance, steps out from behind his bodyguard, and advances toward LeMeurtrier. He welcomes the new arrival in an emotionless voice, but with a thin smile on his face, and bids Raleigh to take the gaunt man's light jacket.

Another round of curt introductions ensues as Raleigh, grumbling to himself and shaking his head, goes off toward the dining hall to have another place set for dinner.

Moments later, you sit down for the meal. Romdril begins the feast with a short, cryptic toast: "To endings and new beginnings." Mennek brings in a sumptuous meal of roast turkey and all the trimmings, and everyone eats heartily with little conversation. The tension in the room becomes almost tangible as all four of the guests seem to be sizing up each other. The unease is broken as the maid, Enni, enters the dining hall and informs Romdril that a fourth guest bedroom has been prepared. Romdril thanks her, resumes eating, and begins to take a more active part in the conversation. Romdril says that there will be plenty of opportunity tomorrow morning to deal with more weighty subjects. Under his direction, the table talk turns to more mundane, less controversial matters. The occasion takes on a more enjoyable tone, and time passes quickly. After about three hours, the meal long since ended, Romdril says he is tired and bids the rest of the group a good night, asking them to reconvene in the morning for breakfast. The guests follow their host out of the dining hall, are shown to their rooms by Raleigh, and the house is quiet for the rest of the night.

Your squad awakens shortly before 8:00

the next morning. You rise quickly, enter the breakfast hall on the upper floor of the mansion, and find the room empty. A moment later, Alkus Alambar and Sandar Fleatis enter together, embroiled in an argument over the mechanics of the elemental planes. They take little notice of you as they sit down and continue their argument. Both men abandon their hostility toward each other when Orian Flaloch enters a minute later, preferring to direct their sarcasm and disgust toward the mayor instead. Flaloch ignores them, but then nearly explodes when Andre LeMeurtrier strolls into the room, smiling, and expresses his desire for a morning repast. Flaloch doesn't try to conceal his hatred for the man and insinuates that LeMeurtrier's kind is "always hungry for something."

LeMeurtrier's smile fades and he is about to respond when Raleigh staggers in from the kitchen stairway and falls to the floor, gasping, "He's dead."

(Note to the DM: Begin timing the adventure now.)

## THE MYSTERY

It is 8:00 a.m. Alexonus Romdril is dead inside his magical library, and the library is on fire. Enni, the maid, is dead in her chambers. Mennek, the cook, is dead in the kitchen cupboard.

Raleigh is suffering from smoke inhalation. He will die from its effects in five rounds unless a member of the PC party applies a *cure serious wounds* spell (or, optionally, the party's single most powerful form of curative magic). In the absence of such magic, a player character may elect to try artificial respiration; if someone thinks of this and begins to employ it before five minutes have elapsed, there is a 100% chance that it will save Raleigh, modified downward by 10% for every minute that passes before the attempt is begun.

If Raleigh is saved, he will be semi-conscious and will be able to give out a small amount of information within the next five minutes. He knows only that Romdril is dead in the magical library, that he himself inhaled a lot of smoke in an attempt to save his master, and that the library was on fire when he was forced to leave the room. He will verbalize these recollections, one at a time in the order given, in response to any pertinent question. After five minutes (whether or not he has given out all of his information) he will slip back into unconsciousness and will remain in this condition for the next four hours; no measures (including curative magic) will hasten his recovery.

Precisely at the moment when Raleigh falls unconscious (or dies), Mok will burst into the breakfast hall. The bodyguard's expression is angry and bewildered; it is obvious that he has just come from his own bedroom and is aware that Romdril is not in the master bedroom. He will demand to know what has happened to Romdril and Raleigh, and will get his desire across by

forcible means if he is not filled in promptly. If he is told of Romdril's death, he will drop to his knees and bury his face in his hands for a few seconds; then, after somewhat regaining his composure, he will pick up Raleigh in his arms (if the servant is still alive) and take him off to Raleigh's bedroom. If Raleigh has died, Mok will simply rise to his feet, wearing a blank stare, and walk aimlessly back out of the breakfast hall without indicating where he is going or what he intends to do.

All the guests elect to stay in the background, watching and listening while the PCs tend to Raleigh and react to Mok, but when this episode ends they remain reticent no longer. Sandar Fleatis is frantic; he will want to know more about what has happened and will express his intent to do some investigating on his own. He will also demand that the PCs be speedy and free with any information they discover. Orian Flaloch is intolerant; he will blame this entire episode on the incompetence of the police force, and will inform the party that his coach is scheduled to arrive at noon and he is leaving at that time. Alkus Alambar is fuming and muttering; he seems distressed and a bit disoriented. He will snap out at everyone and everything and will offer no useful information. Andre LeMeurtrier is no longer in the room, having apparently slipped out unnoticed while the PCs were ministering to Raleigh. The other three guests will stay in the breakfast hall until 8:15 before setting off for their bedrooms, each expressing his expectation (or doubt, in Flaloch's case) that the police will get to the bottom of what has happened.

Orian Flaloch's carriage will indeed arrive at noon (the time by which the case must be solved), as will Alkus Alambar's. (Sandar Fleatis was simply planning to walk home, his house being less than a mile away. Andre LeMeurtrier will not leave the mansion at all.) The player characters should be aware that they have only four hours to solve the mystery; they need to officially charge the murderer(s) with the crime within that time, or at least to have begun an explanation of their solution in the presence of one or more of the NPCs by then.

## THE PLOT LINE

The following list of times and events is a *relative* plot line of the NPCs' actions over the four hours of the scenario. It is relative because the player characters represent an unknown factor that will probably cause changes in the time schedule. For example, Orian Flaloch will not ransack Romdril's bedroom at 9:00 if any of the police are inside the room at that time. Accordingly, the Dungeon Master should view this plot line as a list of the order in which these events will occur, but not stick literally to the times given.

Another important factor for the DM to consider is dramatic effect; if a certain action would be more effective at a different

time, the DM should feel free to move it forward or backward in time by a few minutes. For example, if the PCs decide at 10:55 to take a side trip to the upper gallery on their way to the conventional library, it would be much more effective to hold off on the 11:00 fireball until the PCs get downstairs. Another effect the PCs are going to have on the plot line is that, in all likelihood, they will split up. If they do, certain characters are likely to be in at least one of the right places at the right time.

- 8:00 Raleigh collapses in breakfast hall.
- 8:15 (approximately) Fleatis, Flaloch, and Alambar return to their own rooms.
- 8:30 High-pitched whinnying is heard from horses hitched up to PCs' carriage outside; horses bolt off down the road, carrying the carriage with them. (LeMeurtrier spooked horses to frustrate any suspects who might try to leave the premises — which, of course, also strands the PCs).
- 8:40 Fleatis enters observatory; Mok leaves Raleigh's room.
- 8:45 At least one PC encounters Mok; he runs away.
- 9:00 Flaloch ransacks Romdril's room (looking for incriminating evidence, but not finding any); Fleatis enters conventional library and begins to read Alambar's poison text.
- 9:10 Flaloch leaves Romdril's room; LeMeurtrier enters Mok's room invisibly and steals crossbow.
- 9:15 LeMeurtrier fires one shot at a PC and goes back to Mok's room to replace crossbow; Alambar enters observatory unless PCs are inside.
- 9:25 LeMeurtrier enters observatory; Alambar insults him and hurls a vial of acid in his direction. The acid hits one of the struts holding up the telescope, and LeMeurtrier escapes unharmed.
- 9:30 Telescope in observatory crashes to floor; after one strut was destroyed by acid, the others couldn't support the mechanism and all gave way. Immediately after this happens, Alambar teleports to own room.
- 9:35 Fleatis, Flaloch, and Alambar investigate observatory from different directions; they don't stay long.
- 9:40 Fleatis returns to conventional library; Alambar enters Romdril's bedroom.
- 9:43 Flaloch enters conventional library and begins to argue with Fleatis; Mok enters Romdril's room and surprises Alambar; Alambar casts *power word, blind* on Mok and then uses *dimension door* to return to his own room.
- 9:45 Mok, panic-stricken, thrashes around in hallways on upper level and falls down southern stairs to lower level; he is knocked out, reduced to 0 hit points, and blind.





- 9:50 Fleatis, Flaloch, and Alambar converge on northern stairway and descend to investigate lower part of southern stairway.
- 9:55 Fleatis returns to conventional library; Flaloch enters conservatory; Alambar enters main bath.
- 10:00 LeMeurtrier (invisible) rolls a gas grenade at one or more PCs.
- 10:10 Alambar enters library and argues with Fleatis.
- 10:20 Alambar leaves library, goes to lower gallery, and turns *invisible*.

- 10:25 Fleatis leaves library, heads for manservant's bedroom; LeMeurtrier (still invisible) follows him; Flaloch enters lower gallery.
- 10:30 Fleatis passes unconscious Raleigh on way to Romdril's room and uses mirror in Romdril's room to go to magical library; LeMeurtrier waits invisibly in master bedroom.
- 10:35 Flaloch returns to conventional library.
- 10:50 Fleatis returns to master bedroom via mirror, then goes back to own

room; LeMeurtrier uses mirror to go to magical library; Flaloch goes to upper gallery.

- 10:55 LeMeurtrier returns to master bedroom and goes via Raleigh's room toward corridor west of lower gallery; Flaloch finds wall safe in upper gallery, uses acid to burn it open, and burns the ledger he finds inside.
- 11:00 Alambar *fireballs* LeMeurtrier in corridor, killing him and setting most of the doors in the corridor on fire; when PCs investigate, Alambar creates image of Fleatis fleeing via either north or south end of corridor; doors to conventional library, conservatory, and lower gallery on fire; conventional library begins burning; Alambar teleports to own room.
- 11:05 All NPCs (those still alive) are back in their own rooms,
- 12:00 Flaloch's and Alambar's carriages arrive; Raleigh (if alive) awakens, finds the PCs, and asks if they've solved the mystery.

#### THE MANSION

Romdril Mansion is midway between Kelburn and Jonholm, about twelve miles from each city. It sits in a clearing that extends approximately twenty feet from the mansion in all directions. Beyond the clearing is impassable forest, except for the narrow road that leads to the mansion's front door. This road is unpaved and quite rocky, and twists through the forest for three quarters of a mile before meeting up with the somewhat smoother thoroughfare that runs between Kelburn and Jonholm.

The maps in this adventure describe the layout of the mansion and other details. Other information about the individual rooms and areas is given below.

#### Upper level

**Master bedroom:** Romdril's room is sumptuously furnished. An immense canopy bed occupies much of the area south of the bathroom door. Next to the bed is a nightstand, and a coat rack is at the foot of the bed. In the southwest corner of the room is a dresser and a full-length mirror. The northeast corner contains a bookcase. Two large wicker chairs sit between the windows. The floor is carpeted from wall to wall. (If the characters enter this room after 9:00, the room will have been ransacked.)

The canopy bed is 15' wide, 20' long and 12' in height (to the top of the canopy), and appears *not* to have been slept in during the preceding night. The coat rack supports Romdril's robe, a pocket of which contains a scroll with the spell *geas* inscribed thereon. On the nightstand are a quill, a half-full stoppered bottle of normal black ink, and a candlestick containing an unburned candle. If the candlestick is closely examined, it will be discovered that the white candle has flecks of black powder

sprinkled on it. Anyone ingesting this powder or breathing the fumes it gives off while being burned will suffer ill effects if the character has also tasted both the white powder in Mennek's pocket and either the red liquid in Mennek's pocket or the red wine in the kitchen. If this combination of substances is present in a character's system, he will suffer 2-12 points of damage (save for half damage) and be incapacitated for a number of minutes equal to 20 minus his constitution score. *Neutralize poison* will negate this latter effect.

On top of the dresser is a portrait of a young woman, perhaps twenty years old and very beautiful. The portrait bears the elegantly scripted words, "To my beloved Alex — Thank you. Liana." Below this inscription in a different handwriting are the words, "You shall be avenged." (This painting is of the same young lady as the one in the upper gallery. The portrait will be face down if the room has been ransacked.) The four dresser drawers contain Romdril's clothes, and his boots are on the floor partially under the dresser. The mirror is ornately decorated in gold and platinum, but otherwise appears normal. It is, however, a teleportation device between here and the magical library. The command word, "vermillion," is engraved backward across the bottom of the frame, so that upon first reading it seems to be "noilimrev." Three other words are similarly engraved across the top and down both sides of the frame. If someone stands within one pace of the mirror and utters the command word, the mirror will act as a portal to the magical library for that person only, and the step "inside" the mirror must be taken within five seconds after the word is spoken. If one of the other words is spoken first, or if the time limit expires, the mirror cannot be entered for ten minutes afterward.

The light cedar bookcase contains 117 volumes of Romdril's diary, arranged in order, all similarly bound in brown leather with gold-leaf embellishment. All of them except the most recent (uncompleted) volume are triple-*wizard locked* at the 21st level of magic-use. The last one, Volume CXVII, is freely openable. The entries for the last three days (also reproduced in the document section) read as follows:

"Thursday, October 17: Alkus is still convinced that I have the formula for a potion of longevity! I have told him time and time again that I know of no such elixir, yet he persists. I fear his age is catching up with him. And yet, his judgment remains intact. The servants he recommended seem to know their trades well."

"Friday, October 18: Flaloch has asked to 'make amends.' Hah! How does he expect me to forgive him for what he did to me? Nonetheless, he shall attend tomorrow. I only hope her spirit will forgive me."

"Saturday, October 19: An unexpected guest — LeMeurtrier! I did not believe he had the courage to face me. Still, his arrival bodes ill. Something in the air is wrong; I

fear this may be my last entry."

Romdril's bathroom is normal in all respects, containing a large porcelain bathtub and a toilet both connected by pipes to the water circulation system on the ground level. There is also a candlestand with a full candle on it, plus a grooming set consisting of a hairbrush, shaving razor and clipping scissors, all of which bear the monogram "A.R."

**Bodyguard's bedroom:** Mok's bedroom is very spartan. There is a bed built to his proportions in the northeast corner, a wooden chest in the northwest section of the room, and a weapons rack on the south wall (adjoining the bath). Mok's bed is 10' wide and 15' long. There are no sheets, blankets or pillows on the bed, just a thin mattress covering that is rumpled, indicating that the bed has been slept in recently. The chest has no lock on it and contains several loose shirts and pants in Mok's size. At the bottom of the chest under the clothes is a very expensive mandolin.

The weapon rack holds two heavy crossbows and has space for a third one. (If LeMeurtrier presently has one, then only one other will be in the rack.) Hung on the rack are four quivers, each one containing approximately twenty red-fletched crossbow bolts. There are also four large maces on the rack, with a pair of supports indicating where a fifth one could be stored.

Mok's bathroom is virtually bare, containing only a bathtub (recently used), a toilet, and a small table supporting a candlestand that has only a mass of melted wax on it.

**Breakfast hall:** A large ironwood table occupies the center of the room. There are twelve cedar chairs, five each on the north and south sides of the table and one each at the head and foot. The table is bare; no places have been set for a meal, even though the guests were expecting to be fed at around 8:00.

**Sandar Fleatis's bedroom:** A bed and nightstand are in the western part of the room, a dresser in the northeast section, a full-length mirror on the east wall north of the door, an empty coat rack along the wall on the other side of the doorway, and a table in the southernmost section. The canopied bed is 8' wide and 12' long; it has been slept in recently. On the nightstand is a partially burned candle. The dresser's four drawers are empty, and an empty backpack is lying open on top of the dresser.

On the table are three leather-bound tomes, Fleatis's traveling spell books. The first contains six low-level spells: *magic missile*, *spider climb*, *in visibility knock*, *dispel magic*, and *fireball*. The second contains four medium-level spells: *dimension door*, *wall of ice*, *extension II*, and *passwall*. The third book contains nothing but blank pages.

The bathroom is ordinary, containing a recently used bathtub, a toilet, a facial

mirror, and a candlestand with most of a candle remaining in it.

**Alkus Alambar's bedroom:** There are a few shards of glass on the floor outside the door to Alambar's room.

The room contains a bed and nightstand in the southwest section, a dresser and full-length mirror in the southeast corner, a coat rack on the east wall south of the door, and a table in the northernmost area. The canopied bed is 8' wide and 12' long, and appears to have been slept in recently. (However, though the blanket and pillows are in disarray, the top sheet is still neatly tucked in beneath the pillows.) The candle on the nightstand is entirely melted down. The dresser drawers are empty; the mirror and the table are ordinary.

On the coat rack is the robe Alambar wore last evening. There are several shards of glass in the lower hem of this robe, and one of the pockets is ripped open. Under the robe on the rack is hung a tied leather backpack, with a medium-sized *bag of holding* inside. The *bag* contains five thousand gold pieces, but the entire pack weighs only fifteen pounds.

The bathroom is normal; the bathtub is dry. The room also contains a toilet, a facial mirror, and a candlestand with a candle that has not been burned.

**Orian Flaloch's bedroom:** The room contains a canopied bed and nightstand in the northwest section, a full-length mirror and a dresser in the northeast corner, a coat rack along the wall south of the door, and a table in the southern section. The bed is 8' by 12' and has been slept in recently. The candle on the candlestand has burned only a small amount. The mirror has a hairline crack, but is otherwise normal. The four dresser drawers are empty, as is the top of the table. In Flaloch's coat, which is hanging on the rack, are a key and a small piece of paper upon which is written in perfect script: "Mr. Flaloch, don't forget the Romdril affair to-night. J.R. 10-19." (This paper is reproduced in the document section.)

The bathroom is ordinary and contains a recently used bathtub, a toilet, a facial mirror, and a slightly used candle in a stand.

**Andre LeMeurtrier's bedroom:** The room contains a bed and nightstand in the southwest section, a dresser and full-length mirror in the southeast corner, a coat rack along the wall north of the door, and a table in the northern section.

The canopied bed, 8' by 12', has been slept in recently. On the south side of the bed's canopy is a strange play of lights, only visible to someone who moves around to the south side of the bed. This effect comes from the westernmost stained-glass window on the southern wall, a 4' by 2' section of which has been scored, taken out, and replaced. The pane was put back slightly askew, which causes light to leak in around the edges without passing through the glass

itself. (There are footprints visible on the roof below this window, and the tracks lead directly to the western edge of the roof. For more information about this, see the "outside" section of the mansion description.)

The dresser is empty and the table is bare. The nightstand's candle is half consumed. The coat rack is empty, and the mirror is ordinary. The bathroom contains an unused bathtub, a toilet, a facial mirror, and an unused candle on a stand.

**Astrological observatory:** This huge octagonal chamber is topped by a large glass observation dome 30 feet above the floor. Much of the center of the room is occupied by a mammoth swivel telescope pointed at the heavens. There is a chair attached to the telescope that swivels with the device. There are candlestands all around the room, as well as bookcases that flank the north, south, east, and west doors. (If the PCs enter after 9:30, the telescope will be in pieces on the floor, and one of the struts will show evidence of having been weakened by the application of acid.)

The gigantic swivel telescope is a masterpiece of engineering. The main tube is 40' long and the bore at the top of the tube is 5' across. The telescope can rotate a full 360 degrees on the horizontal axis and can also be pivoted vertically so that it is anywhere from straight up (with the chair's back parallel to the floor) to fully horizontal (the telescope is parallel to the floor). If Alambar has not yet entered the observatory, the telescope will be pointing up (out the observation dome) and to the northeast. In the daytime, the sun completely obscures the view of any other heavenly bodies.

The chair is firmly attached to the telescope, but will be smashed when the crash occurs. On a desktop attached to the chair are a normal pen, a bottle of normal ink, and two books. The first book contains Romdril's charts of the various heavenly bodies. The charts seem to show a movement of a certain group of four bodies toward each other until they meet in what Romdril notes as a "full cupidity." The second book is a text on various formations of bodies, and is open to a page on cupidoria which describes a full cupidity as meaning "cessation." (This page and two pages of the chartbook are reproduced in the document section.) If the telescope has already crashed, these books will be partially visible under the device, but not trapped; they can be recovered and examined, and the second book will still be open to the indicated page.

The candlestands are all filled with unused candles. The bookcases that line the walls are well stocked with scholarly texts on astrology, which anyone without a strong background in astrology would find incomprehensible.

**Upper gallery:** The long walls of this rectangular room are lined with paintings, most of them by world-famous artists and one of them painted by Romdril himself.

The Romdril painting and three of the others have the same subject: a beautiful young woman. One of the other paintings of this woman bears the word "Liana" engraved on its frame. On the frame of the Romdril painting is inscribed this notation: "B 3-15-21, D 12-14-52."

Behind the Romdril painting is a small wall safe. In the center of the square door is a dial marked with numbers from one through sixty and a spinner with an arrow engraved on it pointing to the dial. If the arrow is turned to point to the numbers twelve, fourteen, and fifty-two, in that order, the wall safe will pop open. If a thief attempts to pick this lock, he does so at a 30% penalty.

Inside the safe are a large sack, a smaller sack, a small portrait, a scroll, and a leather-bound ledger. The large sack is a *bag of holding* that contains ten thousand platinum pieces but only weighs sixty pounds. In the smaller sack is a treasure trove of gems, mostly jacinths, rubies, and sapphires. The small portrait is in a heavily inlaid platinum and gold frame, and depicts the same woman as the painting in the master bedroom and the ones noted along the gallery walls.

The seal on the scroll is engraved with the words, "Last Will and Testament of Alexonus Romdril." If the seal is broken, the will (reproduced in the document section) can be read:

"I, Alexonus Romdril, being of sound mind and body, declare this to be my last will and testament.

"It is my solemn wish that my estate be shared equally by my two loyal servants and friends, Mok and Raleigh. It is also my wish that they continue to occupy the mansion, jointly sharing the title of Lord of Romdril Mansion.

"All of my magical possessions not related to the maintenance of Romdril Mansion shall be given to my former apprentice, Sandar Fleatis. Should he desire to occupy Romdril Mansion, he is welcome to do so, although he shall not have the executive ownership of the mansion.

"This I do hereby set in writing in the memory of my beloved Liana, whom I shall meet again in the world beyond.

"Alexonus Romdril, April 10, 1353."

The leather-bound book is titled "Campaign Ledger, November-December 1352." One dog-eared page (reproduced in the document section) describes the misappropriation of ill-gained campaign funds for the date December 12, 1352. One entry has been circled; this reads, "Paid to Andre LeMeurtrier for services rendered, 35,000 gold pieces,"

**Minor guest bedrooms:** These rooms will be found the same way the player characters left them. Each contains a bed, a candlestand, a dresser, a half-length mirror, and a bathroom with a bathtub, toilet, and candlestand.

## Ground level

**Manservant's bedroom:** Raleigh's bedroom is large but sparsely furnished. There is a nightstand next to the bed in the northeast section of the room. A suit rack sits in the southeast corner, and there is a dresser and a full-length mirror between the rack and the southern door.

The bed, 3' by 6', has no canopy. (If Raleigh survives his early-morning ordeal, his unconscious form will be occupying the bed from about 8:15, when Mok brings him here, until 12:00, when the PCs' time limit expires.) On the nightstand are a half-melted candle in a stand and a small piece of paper (see the document section) which reads, "List of Guests: Alkux Alambar, Sandar Fleatis, Orian Flaloch, officers from Kelburn." On the face-down side of this paper is written "12-14-52."

The suit rack contains six formal suits and four empty hangers. There is nothing in the pockets of any of the suits. In the dresser are Raleigh's other clothes and his boots. The mirror is ordinary.

In the bathroom are a recently used bathtub, a toilet, two candlestands with slightly used candles, a facial mirror, and a grooming set (hairbrush, razor, and clipping scissors, none of which is marked in any way).

**Servants' quarters:** All of these rooms are essentially the same. Each contains a neatly made bed (3' by 6'), a nightstand with an empty candleholder, a half-length mirror, and a dresser. In the lower drawer of the dresser in the southwest room is a rotting rag doll; if it is torn open, three copper pieces will fall out.

The servants' bath is divided into two identical rooms, each containing a dry bathtub, a toilet, and an unused candle in a holder.

**Enni's room:** Stuck on the outside of the waist-high hinge on the door to this room is a swatch of black cloth containing a bit of embroidery that seems to be part of a decoration. It has obviously been ripped from a larger piece of the same cloth.

Enni, the maid, is propped up against the headboard of her bed, and is in her bedclothes — with a red-fletched crossbow bolt protruding from her chest. She is unquestionably dead. Under the pillow behind her lower back is a dagger with a wavy-edged blade.

The room has a dresser, a nightstand with a half-consumed candle in its holder, and a full-length mirror. In the dresser are two maid's outfits and a pair of shoes; on top are a maid's hat and a grooming set. The grooming set contains a small facial mirror, a stoppered pottery bottle labeled "Makeup," a hairbrush and comb, clipping scissors, and a small file. The pottery bottle is half-filled with a black powder. (This powder is the same as that which is sprinkled on the candle in the master bedroom; consult the text for that room for what will happen if this powder is tasted.)



**Mennek's room:** This room contains a bed, dresser, half-length mirror, and nightstand. The 3'-by-6' bed has no canopy and has not been used recently. The middle drawer in the dresser holds a set of street clothes. An unused candle is in the holder on the nightstand; next to it is a cookbook with a circle drawn around the recipe for roast turkey.

**Servants' entrance and foyer:** A coat rack is the only object in the foyer. Hung on it are two coats, one slightly larger than the other. In the pocket of the smaller one is a map illustrating the route from Jonholm to Romdril Mansion. On the back side of the map are a few lines of handwriting that describe the procedure for using a special three-stage poison. (This piece of paper is reproduced in the document section.)

The bar is up on the door leading outside. Many different footprints, belonging to at least three different people, are visible in the soft ground outside the door. (For more information, refer to the "Outside" section of the mansion description, below.)

**Kitchen:** The kitchen has not been cleaned recently. Along the northern wall is a large table on which are the leftovers from last night's dinner, plus various cooking implements and spices. The fire pit contains nothing more than warm embers. North of the west door is a wash basin holding the (unwashed) pots used to cook the dinner.

On the floor in front of the table is a puddle of red wine roughly 2 feet in diameter. (The red wine masks a fresh blood stain on the floor. The stain can be noticed under careful examination, and certainly will be if someone reaches down to get some of the wine for a "taste test." If the wine is tasted, see the description of the master bedroom, above, for possible effects.)

The embers in the fire pit will burn unprotected skin, but are cool enough to be moved around by an implement or a heavily covered hand. If the contents of the fire pit are stirred, a small piece of metal will be discovered; it has the shape of a trigger from a crossbow or some similar device.

If the door to the kitchen cupboard is opened, Mennek's body will be seen sprawled on the floor of the small chamber. A red-fletched crossbow bolt has pierced his shoulder; he is still in his cook's uniform, and he is quite dead. One of the pockets of his jacket contains a half-filled vial of white powder. The other one contains a shattered bottle, and a red stain is visible on the pocket and the part of the garment adjacent to it. (If either or both of these substances are tasted, refer to the description of the master bedroom, above, for possible effects.)

**Dining hall:** The immense table in this room has not been completely cleared of the remains from last night's meal. There are twenty-two large chairs around the 40'-long table, ten on each side and one each at the head and foot.

**Sitting room:** This room contains sixteen plush chairs' arranged in a circle, with an unused candle in a holder next to each one. On the cushion of one of the chairs is a book of poetry; under the cushion of the chair to its immediate left is a quill.

**Lounge:** This room has a large couch on the south wall and a loveseat on either side of the southern doors, the eastern one with its back to the east wall. Four other cushioned chairs are scattered around the room, as are six small tables and a dozen candleholders.

**Lower gallery:** The walls in this area are covered with several large paintings; in addition, a pair of statues are displayed on pedestals in the middle of the north and south walls. None of the paintings are by famous artists, no two are of the same subject, and none of them depict the young woman whose visage adorns the upper gallery. The statue on the north wall is a bronze sculpture of a sailing ship, and the southern one is a marble representation of an enraged dragon of some sort. If the head of this latter statue is lifted, a hollow space is revealed that contains a silver key with a blue stripe across the top.

**Conservatory:** Musical instruments line the walls of this room. There are three wooden chairs arranged in a triangle close to the windows; in front of each of these chairs is a music stand. Twenty other small chairs are arranged to form an audience area in the southeast quadrant of the room.

On each of the music stands is the score for a composition that begins as a dirge and gradually turns into an allegro by the end (this can be perceived by anyone able to read music). The parts are for three instruments: flute, violin, and mandolin. Each copy of the score bears the signature of Alexonus Romdril and (also in his handwriting) yesterday's date.

**Conventional library:** Thousands of books fill the shelves in this room. In the center of the room is a table with four wooden chairs around it. On the table are a quill and two ink vials.

The books cover every conceivable subject; they are arranged alphabetically by the author's last name. Some of the noteworthy volumes include several books by Romdril himself on music, zoology, and general science; a small book by Sandar Fleatis on the elemental planes; and a text by Alkus Alambar on poisons. This last volume contains some general information on how to prepare and apply a multi-stage poison. If the library is investigated after 9:15, Alambar's text on poisons will be lying face-down on the table, open to the page containing the above information.

**Gymnasium:** This area contains various exercise equipment, including a great many weights, mats, ropes, bars, and rings. At the end of the crossbow target range is a

bullseye target with three red-fletched crossbow bolts sticking out of the center.

**Main bath and water circulation system:** The bath contains a large bathtub, two toilets, a wash basin, and two spare robes that are completely ordinary.

The water circulation system is a hydraulic marvel. In the center of the room is a metal cylinder 10' in diameter and 15' high, on top of which is a large ceramic jug. (The jug is a *decanter of endless water*.) From the cylinder extend a dozen metal pipes that disappear into the ceiling and then (apparently) to the various bathrooms throughout the mansion.

**Entrance foyer and inner foyer:** The entrance foyer is completely empty. The inner foyer contains six plush chairs and a coat rack, which at present is bare.

### Magical area

Outside the doors to the magical area is a *chime of opening* specially designed to open the *wizard-locked* double doors for ten minutes before the *lock* resumes. If the doors are opened and left open, they will stay this way after the ten minutes have passed, but will re-*lock* when they are again closed. The *wizard lock* is of a special, one-way construction; anyone inside the corridor can exit through these double doors as if they were not locked.

The doors are presently closed and *locked* (from the outside), and the *chime* has 5 charges remaining. If the *chime*, a *knock* spell, or a successful *dispel magic* (against a 21st-level wizard) is used and the doors are opened, the smoke that is trapped in the corridor will rush out. Everyone within 25 feet of the opened doors (or anyone who immediately ventures inside the corridor) must save vs. poison or be helpless with coughing fits for five rounds (four rounds if constitution is 15 or higher). This save must be made every round for as long as the doors are left open, up to a maximum of five rounds. A *cure light wounds* spell or the equivalent will negate this effect.

After some of the smoke has been let out, the characters will be able to make their way through the corridor by crawling. They will be able to ascertain that the source of the smoke is the magical library. (If the fire in the library has been extinguished, five rounds of ventilation — or a *gust of wind* spell — will clear the air.)

In front of the open door to the magical library lies Alexonus Romdril. He is dead from burns covering his entire body. A small, partially burned scrap of paper (reproduced in the document section) is clutched in Romdril's fist.

If it was earlier than 9:00 when the double doors were opened, the library will still be on fire, and the characters should realize that the blaze must be dealt with. (If the doors are not opened until 9:00 or later, the fire will have burned itself out because of lack of oxygen.)

(Text continues on page 57)

you  
black  
you dem  
in the A  
redress to  
so leave me be

12-14-52

White powder: solid food, best in meat

Red liquid: beverage, best in wine

Black powder: this gives off vapors when burned,  
so vapors must be inhaled

List of Guests:  
 Alkus Alambar  
 Sandar Fleatis  
 Orvan Flaloch  
 Officers from Kelburn

CAMPAIGN LEDGER - December 14, 1352

	GAIN	LOSS	
Balance in gold pieces			+ 104,710
Operations expenses		1,985	- 1,985
			102,725
Vote acquisition - District 10		5,000	- 5,000
			97,725
Vote acquisition - District 11		7,000	- 7,000
			90,725
Protection Income	12,000		+ 12,000
			102,725
Contribution - Assassin's Guild	10,000		+ 10,000
			112,725
Contribution - Fighter's Guild	5,000		+ 5,000
			117,725
Contribution - Thieves' Guild	6,500		+ 6,500
			124,225
Paid to Andre LeMewtrier for Services Rendered		35,000	- 35,000
			89,225
Paid to Clayborn Thurun - Access to Magician's Guild		20,000	- 20,000
			69,225
Paid to Gnaestor Thurson Kwill		500	- 500
			68,725
Gambling Income	8,000		+ 8,000
			76,725
Prostitution Income	13,000		+ 13,000
			89,725
FINAL BALANCE, DECEMBER 14, 1352			89,725

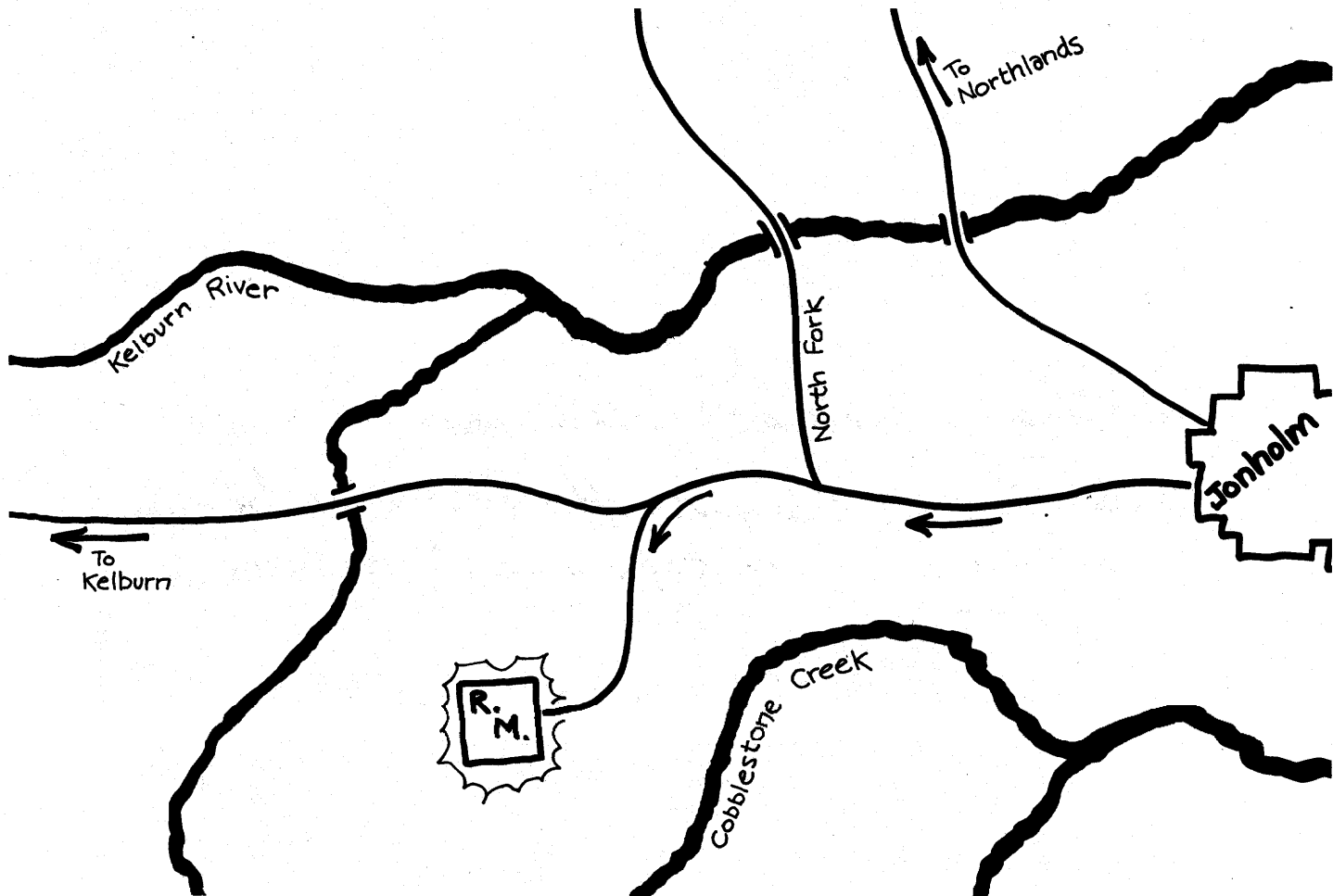

# Tournament player characters

## Lt. Mander Laine

9th level ranger

Strength: 18/26  
Intelligence: 17  
Wisdom: 16  
Dexterity: 13  
Constitution: 14  
Charisma: 17

Hit points: 59  
Armor class: 5

Spells:  
Detect magic (Dr)  
Light (MU)

Special abilities:  
Tracking  
+ 9 vs. giant-class humanoids  
3/2 attacks/round  
Surprise on 1-3  
Surprised on 1 only

## Command Division

Lawful good

Magic items:  
Elfin chain mail  
Longsword + 2  
10 bolts +2  
Ring of fire resistance

Other items:  
Light crossbow  
Uniform  
Badge and identification  
Dagger  
Lesser mistletoe  
Handcuffs and blindfold  
10' rope

## Officer Colin Myrrh

2nd level fighter/8th level cleric

Strength: 16  
Intelligence: 16  
Wisdom: 18  
Dexterity: 10  
Constitution: 12  
Charisma: 15

Hit points: 55  
Armor class: 5

Spells:  
Detect magic  
Cure light wounds ( x 3)  
Create water  
Hold person  
Find traps  
Silence 15' radius  
Resist fire  
Know alignment  
Cure blindness  
Cure disease

## Theological Division

Lawful good

Magic items:  
Potion of clairvoyance  
Shield + 2  
Scroll of protection  
from magic

Other items:  
Spell components  
Holy symbol  
Uniform  
Badge and identification  
Mace  
Handcuffs and blindfold  
10' rope  
Chain mail

Locate object ( x 2)  
Detect lie  
Cure serious wounds  
Neutralize poison

## Officer Kai Randar

2nd level fighter/8th level magic-user

Strength: 12  
Intelligence: 18  
Wisdom: 16  
Dexterity: 15  
Constitution: 15  
Charisma: 14

Hit points: 29  
Base armor class: 10

Spells:  
Magic missile  
Shield  
Ventriloquism  
Detect magic  
Detect invisibility  
Knock  
Levitate  
Phantasmal force  
Protection from normal missiles  
Dispel magic  
Rary's mnemonic enhancer  
Ice storm

## Thaumaturgical Division

Lawful good

Magic items:  
Spell scroll (Message,  
Anti-magic shell,  
Pyrotechnics)  
Helm of comprehending  
lang. & reading magic  
Potion of healing  
Short sword + 1

Other items:  
Spell components  
Uniform  
Badge and identification  
Dagger  
Vial of acid  
Handcuffs and blindfold  
10' rope

## Officer Velton Sectal

2nd level fighter/8th level thief

Strength: 12  
Intelligence: 16  
Wisdom: 15  
Dexterity: 18  
Constitution: 11  
Charisma: 12

Hit points: 33  
Base armor class: 8

Thief abilities:  
Pick pockets 80%  
Open locks 72%  
Find/remove traps 60%  
Move silently 82%  
Hide in shadows 64%  
Hear noise 25%  
Climb walls 106%  
Read languages 40%  
Backstab at + 4 to hit and triple damage

## Espionage Division

Lawful neutral (good tend.)

Magic items:  
Dust of appearance  
(4 pinches)  
Short sword + 2  
Potion of flying  
Potion of invisibility  
(4 doses)

Other items:  
Thieves' tools and picks  
Dagger  
Hooked grapnel and  
20' of line  
Flask of oil  
Flint and steel  
Vial of acid  
Handcuffs and blindfold  
Leather armor



# Romdril Mansion Ground Level

Ceiling height  
15' except in  
magical area (20')

Stairs to  
master bedroom

Servants' entrance

Stairs to breakfast hall

Servants' quarters

Outer doors  
are heavy oak  
with iron  
bracings;  
all other  
doors made of  
light oak

Cupboard

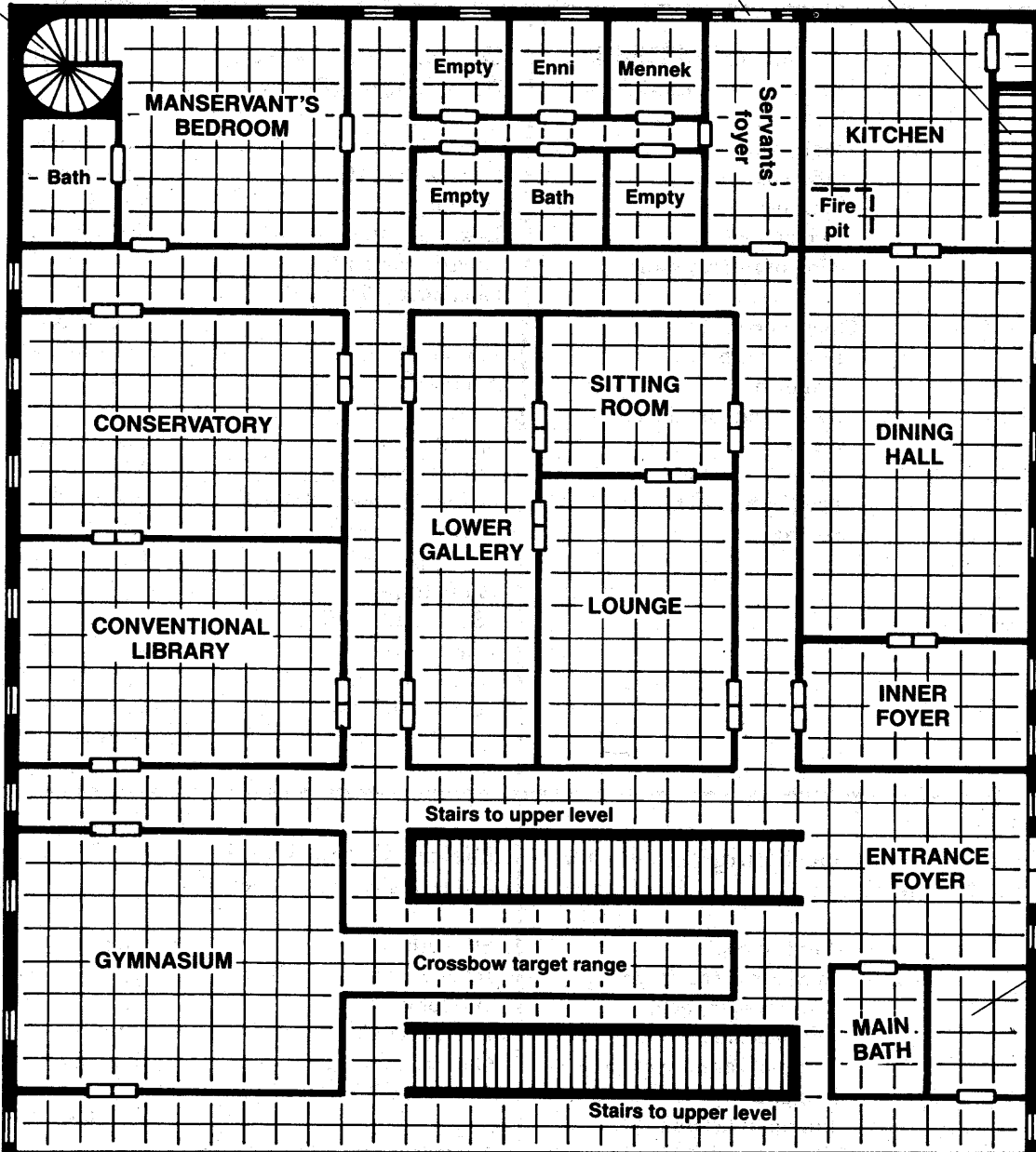

Water circ. system

Windows made  
of stained glass;  
each is 8' tall  
starting 4' above  
floor level

Outer walls  
made of stone;  
inner walls  
made of wood

Magical area  
walls are stone  
with iron bracing

Magical area  
rooms separated  
by glassteel

Conjunction and  
summoning chamber  
only accessible  
by phase door spell

Magical area  
rooms soundproof

1 square = 5 feet

# Romdril Mansion Upper Level

Windows made of stained glass; each is 8' tall starting 4' above floor level

Stairs to manservant's bedroom

All doors made of light oak

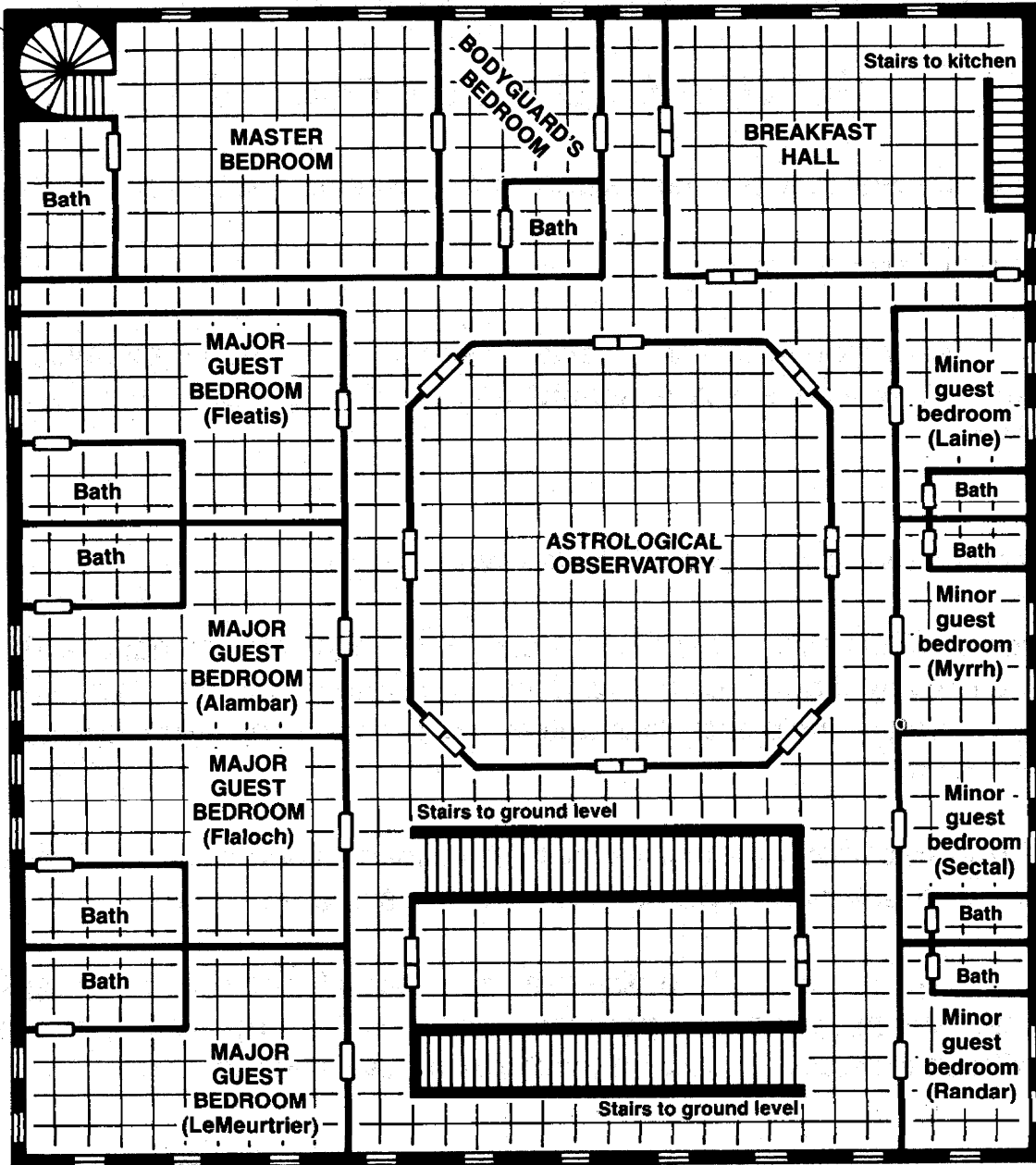

(Roof of magical area on ground level; top is three feet above upper level floor)

Ceiling height 15' except observatory dome (30')

1 square = 5 feet

# KELBURN CIVIL RIGHTS CODE

## Section C: Police Conduct

1. Police officers may not take sentient life except in self-defense, and then only if no other means are available to protect the safety and welfare of the officer.
2. Unnecessary violence in the apprehension of a suspected criminal is prohibited. Violence may be employed only if no other means are available.
3. Protection of any innocent person takes precedence over the apprehension of a suspected or known criminal.
4. Police officers may not detain a person not officially charged with a crime for any length of time, and may not prohibit a person from undertaking normal activities unless the person is officially charged with a crime.
5. The interrogation of a person not officially charged with a crime is prohibited unless that person consents to being questioned.
6. Police officers do not have the power of search and seizure except as regards the property and persons of dead victims of crimes, or when an officer is searching for or confiscating evidence to be used in the prosecution of officially charged subjects.
7. Police officers may not employ psionic powers, detection magics, and other such forms of divination except on a person who has been officially charged with a crime.
8. It is illegal for an officer to officially charge a person with a crime without specific knowledge or possession of unimpeachable, substantial evidence or the voluntary confession of the person in question.

Saturday, October 19

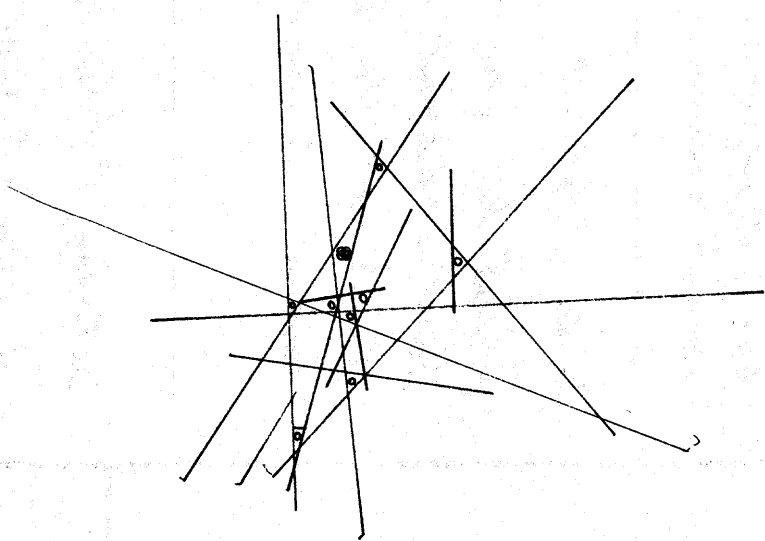

Full Cupidory

Friday, October 18

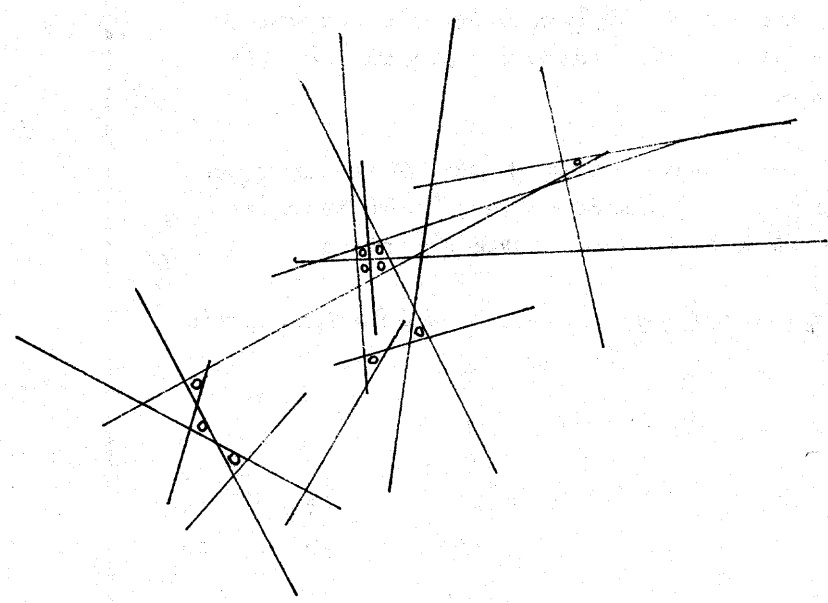

Wanch for possible cupidory quadrilateral cusp tonomaw

CUPIDORIA

- oo Partial cupidory
- oo Sequential cupidory
- oo Exponential cupidory
- oo Levellant cupidory
- oo Translevellant cupidory
- oo Negatory cupidory
- oo Internegatory cupidory
- oo Elementary imbrecating cupidory
- oo Primary imbrecating cupidory
- oo Imbrecating sequential cupidory
- oo Imbrecating exponential cupidory
- oo Translevellant imbrecatory cupidory
- oo Potential full cupidory
- oo Full cupidory-CESSATION

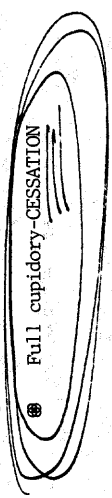



Thursday, October 17

Albus is still convinced that I have the formula for a potion of longevity! I have told him time and time again that I know of no such elixir, yet he persists. I fear his age is catching up with him. And yet, his judgement remains intact. The servants he recommended seem to know their trades well.

Friday, October 18

Flabob has asked to "make amends." Hah! How does he expect me to forgive him for what he did to me? None the less, he shall attend tomorrow. I only hope her spirit will forgive me.

Saturday, October 19

An unexpected guest - the Murtner! I did not believe he had the courage to face me. Still, his arrival bodes ill. Something in the air is wrong; I fear this may be my last entry.

I, Alexonus Romdril, being of sound mind and body, declare this to be my last will and testament.

It is my solemn wish that my estate be shared equally by my two loyal servants and friends, Mok and Raleigh. It is also my wish that they continue to occupy the mansion, jointly sharing the title of Lord of Romdril Mansion.

All of my magical possessions not related to the maintenance of Romdril Mansion shall be given to my former apprentice, Sandar Fleatis. Should he desire to occupy Romdril Mansion, he is welcome to do so, although he shall not have the executive ownership of the mansion.

This I do hereby set in writing in the memory of my beloved Liana, whom I shall meet again in the world beyond.

Alexonus Romdril  
April 10, 1353

MR. FLALOCK,  
DON'T FORGET THE ROMDRIL AFFAIR TO-NIGHT,  
J.R. 10-19

(Continued from page 48)

The other two doors in the magical area (leading to the magical laboratory and the alchemical laboratory) are not locked and will open freely. But if either one is opened before the corridor is cleared of smoke, the smoke will rush into the room in question and render the air inside unbreathable for at least five minutes.

**Magical library:** If the library is still on fire when the characters arrive, they will have to use whatever means are at their disposal to put out the blaze. Spells such as *create water*, *precipitation*, *cloudburst*, *ice storm*, or combinations of these are likely to be at least partially effective. A *decanter of endless water* (from the water circulation system) will also be helpful, as will the fire extinguisher in the alchemical laboratory (if it is discovered in time).

Regardless of how, or how soon, the blaze is extinguished, all of the texts in the magical library will have been reduced to ashes, as will the bookshelves, table, and chairs. Two objects will survive the fire. The first is the mirror on the east wall, just to the north of the section of wall composed of glassteel. This mirror is the other half of the teleportation device that allows travel back and forth from the magical library to the master bedroom; it is identical, and operated in identical fashion, to the mirror in the bedroom. (See the description of that room for details.) The second item will be discovered if the ashes in the vicinity of (what once was) the table are searched. It is a small iron chest, unlocked, containing more than fifty precious gems with a total value of more than 100,000 gold pieces.

**Magical laboratory:** This room has not been affected by the fire. There are counters on all the walls, on which are placed various books and experiments. There is also a large cylindrical device in the center of the room.

All of the experiments are in the preparatory stages; none of them have actually been begun. The four separate endeavors seem to involve, respectively, some kind of necklace; a heavy crossbow (which is present); something having to do with the elemental plane of fire; and a large, blue icosahedron. No other information is discernible, even with careful examination or the use of *read magic*.

The cylindrical device in the center of the room is 10' in diameter and three feet high, and is giving off a low, humming sound. It has a lid, upon which is inscribed the word "Whirligig." The lid can be easily removed, but if someone takes it off without first speaking the word, the contents of the cylinder will fly out in all directions, covering the room and all its occupants with a green, sticky substance. This substance has no ill effect, and can be washed off with water.

**Alchemical laboratory:** This area is free of fire damage. Counters cover all the walls; books, beakers, and liquids abound.

A more than cursory look will reveal that this room has been slightly disturbed. Two potion bottles have been broken on the floor; one contained a white liquid and the other a yellow liquid. Where the two substances have flowed together on the floor, the resulting liquid is a dull crimson color. There is also a large spill of sparkling water on one of the south counters. One of the books has been opened and turned upside down, several of its pages being bent in the process. A small bottle of white pills is broken on the floor in the southeast corner. All of the alchemical products mentioned above will have no ill effects if they are ingested; however, the dull crimson mixture will cause severe hiccups for 1 - 10 rounds to anyone who tastes it. The small white pills can be used to treat a slight case of smoke inhalation or other respiratory damage. (One pill will not help Raleigh, and if more than one is put in his mouth, he will choke and spit the pills out. His condition will not improve.)

The experiments here are all in preparatory stages. Most of them are undecipherable, but *read magic* will reveal that four of the experiments are concerned with the following subjects: color; strength; green slime (not present); and the eyes of umber hulks (not present).

Also in the laboratory is a 1' tall, spongy cylinder labeled "Fire." If this cylinder is brought into an area with a temperature of 120 degrees F. or higher (such as the magical library, if it is on fire) and then dropped or struck with a sharp blow, it will explode, spraying an area of up to 10,000 sq. ft. with a white foam that will smother any blaze. The foam will gradually evaporate over one turn after the object explodes.

**Conjuration and summoning chamber:** If this area is somehow reached, it will be found to be bereft of furniture, having only various signs and sigils on the floor. The edges of the walls are curved, so that there are no sharp-angled corners in the entire room.

#### Outside the mansion

The area around the main entrance is well-traveled. At the start of the adventure, only one carriage will be outside the mansion (the vehicle the characters arrived in). This carriage is 20 feet from the main entrance, with the horses loosely tethered to a tree.

The trail from Andre LeMeurtrier's window leads to the edge of the roof, then resumes on the ground immediately below the roof. It leads around the west side of the mansion and then around the north side to the servants' entrance. At the entrance, the trail is obscured by other footprints. In the dirt just outside the conventional library there are six blue fletchings, probably from arrows or crossbow bolts.

On the roof of the mansion, one can see into the astrological observatory through the dome. During the day, the observatory is always illuminated from above.

## THE SUSPECTS

### Sandar Fleatis

11th-level magic-user: STR 14, INT 17, WIS 16, DEX 13, CON 12, CHA 11, COM 11. Hit points 29, armor class 7, alignment neutral, age 30, height 5' 11") weight 165.

Spells: *magic missile*, *spider climb*, *detect magic*, *read magic*, *invisibility*, *detect invisibility*, *knock*, *levitate*, *dispel magic*, *fireball*, *clairvoyance*, *suggestion*, *wall of ice*, *dimension door*, *minor globe of invulnerability*, *passwall*, *extension II*, *wall of force*.

Possessions worn: brown *cloak of protection* + 3, *brooch of shielding* (40 charges) on gold chain, *ring of free action*, gray robe with gold embellishment, two gold rings, coral bracelet, belt pouch, high soft boots.

Possessions carried: *potion of polymorph*, *wand of negation* (38 charges), spell components, 25 pp.

Reactions to interrogation: Fleatis will be impatient with questions, and will answer curtly if at all. If the PCs detain him for too long, he will become disturbed and demand to know why the investigators don't get on with the case at hand.

Personal history: Sandar Fleatis runs the magic-users' guild in Kelburn, and is outspoken against the policies of Orian Flaloch. He used to be Alexonus Romdril's apprentice; he lived in the mansion and had access to all of its rooms and conveniences, until he and Romdril decided it would be better if Sandar left. Since his departure last April, Fleatis had not spoken at any length to Romdril until the previous night. Fleatis claims he has no political aspirations, but would like nothing better than to see his former tutor back in office. He says that he intended to use this invitation to the mansion as an occasion to persuade Romdril to re-enter the political arena, as well as to petition him for a *geas* spell.

Answers to key questions:

*Did you kill Romdril?* "Of course not."

*Who killed Romdril?* "I'm not yet certain, but I intend to find out."

*What do you have against Orian Flaloch?* "He is destroying everything Alex worked for."

*What do you think of Alambar?* "He's gone senile. What a shame."

*What do you know about LeMeurtrier?* "I've got nothing on that cutthroat."

*Did you kill LeMeurtrier?* "He's dead? It's about time. Someone should have taken care of him long ago."

*Why did you and Romdril part company?* "He no longer wanted to remain in Kelburn. I did."

*How did Liana die?* "I don't yet know."

*Where have you been since 8:00?* "In the library, reading about poisons."

*Did you come back to your room from the library?* "Straight from the library, yes."

### Alkus Alambar

18th-level magic user: STR 4, INT 18, WIS 12, DEX 6, CON 7, CHA 7, COM 7. Hit points 20, armor class 4 (with *bracers*),

alignment chaotic neutral, age 85, height 5'3", weight 101.

Spells: *affect normal fires*, *light*, *erase*, *feather fall*, *detect invisibility*, *invisibility*, *darkness 15' radius*, *fireball*, *phantasmal force*, *hold person*, *dimension door (x 2)*, *ice storm*, *cause fear*, *confusion*, *teleport (x2)*, *cloudkill*, *extension II*, *disintegrate*, *repulsion*, *power word stun*, *power word blind*, *prismatic sphere*.

Possessions worn: black robe with gold sigils, *girdle of many pouches*, *dagger + 3*, *amulet of life protection*, *bracers of defense (AC 4)*, low soft boots.

Possessions carried: *potions of fire resistance*, *speed*, and *extra healing*, *oil of acid resistance*, *scroll of protection from petrification*, spell components, gold ring, 20 pp.

Special characteristics: Alambar is protected by *mind blank* for the duration of this scenario. Because of his age, he suffers from many illnesses, including a very severe respiratory disorder. Any vigorous activity (combat, prolonged exertion, running more than a short distance) will cause this lung disease to incapacitate him.

Reactions to interrogation: Alambar will not stand for any type of extended interrogation. He is in a temperamental mood and will lash out (verbally) at anyone he feels deserves such treatment. He will respond to any question with sarcasm or an insult, but may incidentally provide some relevant information in the context of his tirade. He will demand to be addressed by his full rightful title, Chief Alchemist of Jonholm.

Personal history: The few scraps of information he may give out include only that he is Chief Alchemist of Jonholm, that he and Romdril were associates for many years, and that he came here only because he assumed Romdril had a good reason for inviting him.

Answers to key questions:

*Did you kill Romdril?* "That is sheer idiocy."

*Who killed Romdril?* "How in all demonfire would I know?"

*Did you kill LeMeurtrier?* "Use your brain. I have never met the man before."

*Did you recommend the servants to Romdril?* "Yes, and they had the gall to get themselves killed for it."

*Did you kill the servants?* "That would certainly cast doubts on my recommendations, wouldn't it?"

*What was your relationship with Romdril?* "He and I knew each other. I know many other important people, and I'm sure he did, too."

*What do you think of Sandar Fleatis?* "That kid could use some maturity."

*How about Orian Flaloch?* "If that idiot wants to cut off diplomatic relations with my city, it isn't my problem."

### Orian Flaloch

0-level human; politician by trade: STR 14, INT 17, WIS 17, DEX 14, CON 16, CHA 18, COM 18. Hit points 6, armor class 10, alignment lawful evil, age 39,

height 6'4", weight 180.

Spells: none.

Possessions worn: spotless brown suit and thin black jacket, amulet of proof against *detection and location*, high hard boots.

Possessions carried: small vial of acid, 20 pp.

Reactions to interrogation: Flaloch will be unhappy about any hesitation on the part of the PCs, condescendingly decrying the police force's incompetence and uselessness. He will demand to know of any information the PCs have uncovered pertaining to Romdril's murder, and will threaten them with dismissal from the force if they do not comply. If the PCs are properly deferential and quick in their questioning, and if Flaloch is convinced they are not using magic in the interrogation, he may respond eloquently and at length to questions.

Personal history: Orian Flaloch will steadfastly maintain that he gained Kelburn's highest office through his hard work and perseverance in a fair election. He harbored Romdril no ill will, regardless of his opponent's alliance with the demons of magic. Indeed, Flaloch believes that Romdril finally outlived his usefulness to the hordes of Hades, and was taken by demonkind to the horrors of the underworld. Flaloch grieves for the loss of so worthy an opponent. He hoped that he could steer the arch-mage away from his likely fate, and agreed to come to the mansion with the intent of trying to convince Romdril of the error of his ways and to improve relations with him.

Answers to key questions:

*Did you kill Romdril?* "Certainly not."

*Who killed Romdril?* "His own personal demons, and those who preyed on him. Truly a shame."

*Why did you want to make amends with Romdril?* "The bad blood between us could not continue if his soul was to be saved."

*What do you know about Liana Romdril's death?* "She was a lovely young lady; it was truly a tragedy that she died of natural causes at so young an age."

*Did you kill LeMeurtrier?* "Unfortunately, the laws of Kelburn forbid justifiable homicide."

*Why did you hate LeMeurtrier?* "His corruption and killing blighted the good works of my administration."

*What do you have against magic?* "It is demonwork used by the legions of the netherworld to corrupt the minds of right-thinking persons."

*What do you know about this ledger entry?* "It . . . uh . . . must be a f-f-forgery. I've never seen it before."

*Do you know that the amulet you're wearing is magical?* "Ridiculous. It is the official Kelburn amulet of state. If you suspect that it is magical, then you could only suppose that after the use of magic yourself. You are not fit to remain in the employ of the good city of Kelburn, and when I return to my offices later today I will recommend that you be dismissed from the police force."

### Andre LeMeurtrier

14th-level assassin: STR 17, INT 18, WIS 17, DEX 18, CON 14, CHA 15, COM 12. Hit points 47, armor class 6, alignment lawful evil, age 32, height 6'2", weight 160.

Spells: none.

Thieving abilities: PP 110, OL 92, FT 80, MS 104, HS 87, HN 35, CW 99.2, RL 60; + 4 to hit and quintuple base damage on backstab.

Possessions worn: Light brown jacket and traveling clothes, *boots of elvenkind*, *ring of feather falling*, *ring of invisibility*, *medallion of ESP*.

Possessions carried: *dagger of venom*, gas grenade (produces 1" diameter gas cloud when set off; all within cloud take 3-18 points of damage, save vs. poison for half), tiny flask of poison (save vs. poison or die if imbibed), thieves' tools, 10 gp in cotton-filled pouch.

Reactions to interrogation: None. The PCs will not be able to question LeMeurtrier before his death.

### Raleigh

0-level human, manservant by trade: STR 10, INT 16, WIS 16, DEX 10, CON 9, CHA 10, COM 10. Hit points 4, armor class 10, alignment lawful neutral, age 52, height 6', weight 125.

Spells: none.

Possessions worn: suit and tie.

Possessions carried: 15 gp in belt pouch.

Reactions to interrogation: Raleigh will be unable to answer any questions except as outlined in the section above entitled "The mystery."

### Mok

7th-level fighter: STR 18/95, INT 10, WIS 10, DEX 18, CON 18, CHA 6, COM 9. Hit points 50, armor class 6, alignment neutral, height 6' 11", weight 220.

Spells: none.

Possessions worn: loose shirt and pants, bandolier.

Possessions carried: *crossbow of speed*, 20 red-fletched bolts in quiver, large mace (2-12 damage).

Reactions to interrogation: Mok is mute and cannot read or write. He does not know a formal sign language, but does try to communicate with gestures and facial expressions. He knows of the existence of the magical area, and can enter that area by using the *chime* on the double doors, but does not know about the teleport device.

### THE SOLUTION

The death of Liana Romdril was the turning point of the Kelburn mayoral election campaign of 1352. Her husband, Alexonus Romdril, sacrificed his bid for re-election and effectively forfeited the election to his challenger, Orian Flaloch, in his determination to discover the reason behind his wife's sudden death. Romdril knew there was no sensible explanation for the young Liana's heart attack — at least, no natural explanation.

For several months after the incident Romdril used all the means he could muster, legal and otherwise, to obtain information about Liana's death. For the better part of a year, his quest was fruitless. He channeled much of his resources into the search while his personal life deteriorated. Sandar Fleatis, who had been staying at Romdril Mansion, left in April after a bitter argument with the arch-mage. Fleatis was distressed that Romdril had become obsessed with finding Liana's killer, even though he had found no evidence that a killer existed. Fleatis pressed Romdril for an explanation of how this single-minded search was benefitting the people of Kelburn, who were suffering under the Flaloch administration. Romdril, who could not accept anything less than complete devotion to his investigation, refused to respond, and Fleatis left harboring much resentment. Romdril continued to pursue his goal.

Finally, on October 13, the arch-mage's efforts were rewarded. A bribe and a threat to one of Flaloch's lackeys gained Romdril the mayor's campaign ledger for November-December 1352. The entry for December 14 confirmed what some of his other information had hinted at: Orian Flaloch had paid the renowned Kelburn assassin Andre LeMourtrier the princely sum of 35,000 gold pieces to murder someone — on the very day that Liana died.

Romdril sent a communique to Flaloch, revealing to the mayor that he possessed definite proof of Flaloch's corruption but not telling him exactly what he knew. The mayor panicked and sent back a request for what Romdril would demand in return for not exposing Flaloch. The arch-mage invited Flaloch to attend an overnight gathering at his mansion beginning on October 19, and suggested that the mayor bring what he considered an appropriate gift. Flaloch agreed enthusiastically, adding that he hoped to improve relations between the two men.

Flaloch did not guess that the only gift Romdril wanted was his enemy's dying breath. Accordingly, the mayor siphoned off as much of the taxpayers' money as possible and quickly purchased as many precious stones as the money could buy, adding whatever he could spare from his personal treasury. He packaged these gems — more than 100,000 gold pieces worth — in an iron box and enclosed a note reading: "Romdril, these priceless gems are yours as payment. I don't know what black arts you used, but I've seen you do worse with your demonwork. I hope you rot in the Abyss for this. You've now got your redress for what happened, so leave me be!" Flaloch foolishly hoped the gems would appease Romdril; if not, he reasoned, then he would simply have to once more purchase the services of LeMourtrier to rid himself of Romdril forever.

To disguise his true intentions, Romdril invited two other dignitaries to his mansion along with Flaloch. After the mayor was

disposed of — any one of a number of spells would do the trick, and it would be simple to make it look like self-defense — Romdril hoped to gain the renewed allegiance of both Alkus Alambar and Sandar Fleatis and join with them in an effort to again bring about good relations between Kelburn and Jonholm.

Alambar accepted the invitation gladly, seeing it as an opportunity to further his own ends. He had spent many years trying to discover the secret to the much-coveted *potion of longevity*. Alambar could not succeed through his own efforts, and he became convinced that his former friend Romdril knew the secret but was withholding it from him. Alambar's time was growing short; at his age and in his present condition, he was unlikely to live much longer. In desperation, Alambar reasoned that if Romdril would not allow him to live a longer life, the former mayor would die before he did. After hiring two cutthroats from the Jonholm assassins' guild, Alambar armed them with a three-stage poison — the first two stages to be ingested with the food and drink of the evening meal and the last to be inhaled from the fumes of the candle in the arch-mage's bedchamber. Alambar recommended these two assassins as the perfect servants for the gathering that Romdril was hosting on the 19th, and Romdril agreed out of deference to the old man, hiring them as the cook and maid for the occasion.

Fleatis also accepted the invitation gladly, seeing it as an opportunity to make amends with Romdril and to pursue a couple of his personal goals. He intended to petition Romdril for knowledge about the *geas* spell, and also wanted to elicit his former master's support for the campaign Fleatis was planning in an effort to unseat Flaloch in the next election.

Alambar's hiring of the two assassins became known to LeMourtrier, the head of the Kelburn assassins' guild, through spies that he had planted in the Jonholm guild. LeMourtrier strongly suspected that the object of the assassination attempt would be Romdril himself, and he decided that a job of this magnitude would net the rival guild more money than he could countenance. The best solution, he reasoned, was to let the assassins do their work, then dispose of the killers and make off with the money they were to be paid — all of which would serve to further incite the conflict between the Kelburn and Jonholm assassins' guilds. LeMourtrier showed up at Romdril Mansion on the night of the gathering. After hiding his crossbow and poisoned bolts in the underbrush outside the mansion, he made himself part of the gathering. Romdril, anxious not to give away his true purpose, greeted the assassin hospitably, and LeMourtrier responded in kind, even though each man knew the other would kill him at the slightest opportunity.

Romdril was not terribly put off by LeMourtrier's appearance, since he had taken the precaution of having a small group of

police officers present. He expected that a death (Flaloch's) would occur at or before noon on the 20th, and he wanted the police on the premises as impartial witnesses to document what would happen. In the meantime, Romdril supposed, the presence of the officers would prevent the occurrence of any untoward events.

The dinner on the evening of the 19th was intended as a hospitable prelude to the following day, when the principals would all engage in conversation and negotiation. The meal was served, complete with poison. No one present detected the poison (nor attempted to), but Alambar already knew of its existence and LeMourtrier suspected that such was the case. The assassin's expertise with poisons enabled him to deduce that it must be a multi-stage mixture, and that the final component would be administered in such a way that no one but the intended victim would be affected.

As it happened, the third stage was never activated. The maid was able to slip away during dinner and sprinkle the black powder on the candle in Romdril's bedroom, but the arch-mage did not use the candle. He entered his bedroom, picked up the box Flaloch had brought, and used the mirror to get to his magical library.

LeMourtrier was correct in his suspicion that Romdril was meant to be the victim of the poison. He was incorrect, however, in his assumption that the deed would be done shortly after Romdril retired to his room at about 11:00. Before LeMourtrier went to his own bedroom, he slipped into the servants' foyer and lifted the bar on the outside door. Then he proceeded upstairs, picked the lock on the door to Mok's bedroom, and "borrowed" two bolts that he knew would not be missed. At midnight he sliced a panel out of his bedroom window and exited the house. He stopped briefly outside to pull the blue fletchings out of the poisoned bolts he had brought along and replace them with the red fletchings from Mok's bolts. He then re-entered the house through the servants' entrance. Using invisibility and stealth, he killed the maid and the cook where he found them, being careful in each case to leave clear evidence that they carried poison. He then disposed of his own crossbow and the two extra bolts in the fire pit before going back to his room, but forgot about re-lowering the bar on the door to the servants' entrance. He repaired the window (although not perfectly) and got a few hours of sleep, secure in the knowledge that he had disposed of the Jonholm assassins and at the same time established Mok as the prime suspect.

Alkus Alambar's anxiety got the best of him at about 4:00 a.m. He left his room, went down the hall toward the master bedroom, and employed a *clairvoyance* spell to ascertain — much to his surprise and outrage — that Romdril was not lying dead inside his bedroom. He went to the servants' quarters and found the maid dead and the cook missing. He assumed that Romdril was somehow responsible for their



death and disappearance, which further strengthened his resolve to see the archmage dead. Through the use of an educated guess and another *clairvoyance* spell, he found Romdril in the magical library examining the contents of a small iron box. He cast a *knock* spell on the doors leading to the magical area and entered the alchemical laboratory after using *invisibility* on himself. Becoming more irrational by the second, he then decided to cast *delayed blast fireball* on the magical library, setting the "timer" on the blast to go off in two minutes. By means of a *potion of clairaudience* and a *ventriloquism* spell, he contacted Romdril and demanded to know everything about the *potion of longevity*. Romdril, startled by the intrusion on his concentration, closed the box of gems as he replied that he had no such knowledge. Alambar began to go on a rampage in the alchemical laboratory, haphazardly searching for the nonexistent potion. Romdril was in the process of trying to persuade Alambar to calm down when the *fireball* went off. Alambar had enough presence of mind to pull out the bottle of pills he used for his respiratory disorder and swallowed one to ward off the possible effects of smoke, but then he dropped the bottle, which shattered on the floor unbeknownst to him. He vacated the area shortly after the blast, exiting through the double doors and closing them before any appreciable amount of smoke could get through the opening.

Romdril managed to crawl to the door of the library and push it open before he died, still reflexively clutching the remains of Flaloch's note. Raleigh, on his early-morning rounds intending to tidy up the library, discovered the smoke and Romdril's body some three hours later. He panicked, and inhaled a lot of smoke while vainly trying to revive his master. Dazed and gasping, he bolted from the area, instinctively closed the doors behind him, and ran up the stairs to the breakfast hall at precisely 8:00.

## THE EVIDENCE

The following is a list of all the relevant evidence to be found in the mansion.

Romdril's bedroom: scroll of *geas* supports Fleatis's story; flecks of powder on candle point to attempt to murder Romdril; portrait of Liana reveals that Romdril suspects his wife was murdered; diary entries show that Alambar wants *potion of longevity*, that Alambar arranged the presence of the servants/assassins, that Flaloch committed some crime against Romdril and Liana ("her spirit") which LeMeurtrier was involved in, and that Romdril anticipated an attempt on his life.

Mok's bedroom: Crossbow missing after 9:10 directs suspicion away from Mok.

Fleatis's bedroom: Blank spell book suggests that Fleatis is here to obtain a spell for the book.

Alambar's bedroom: Shards of glass outside room and in hem of robe point to Alambar's visit to alchemical lab; torn robe

indicates he visited maid's room; unused bed suggests that Alambar was awake (and probably occupied) for most or all of the night; *bag of holding* containing platinum pieces points to his hiring of assassins.

LeMeurtrier's bedroom: Damaged window suggests that LeMeurtrier left the mansion secretly.

Upper gallery: Text of will removes motive from Fleatis; ledger points to Flaloch's and LeMeurtrier's involvement in Liana's death.

Raleigh's bedroom: List of guests confirms that LeMeurtrier was not invited; also gives combination to safe (which Romdril had ordered Raleigh to change the day before).

Maid's bedroom: Dagger indicates she is an assassin; powder suggests that she worked for Alambar (who provided it to her).

Servants' entrance: Poison "recipe" on back of map indicates that servants from Jonholm were assassins, and their connection with Jonholm suggests that they were hired by Alambar.

Kitchen: Powders and liquids point to Alambar's hiring of assassins; cook's shoulder wound points to LeMeurtrier's murder of cook (obviously a poisoned bolt, since the wound itself would not be fatal); crossbow part in embers points to LeMeurtrier's (not Mok's) attack on cook.

Magical corridor: Note in Romdril's hand points to Flaloch's involvement in Liana's death.

Magical library: Box of gems suggests Flaloch's involvement in Liana's death.

Alchemical laboratory: State of disrepair and broken bottle of pills point to Alambar's murder of Romdril.

Outside: Trail leading from LeMeurtrier's window indicates his murder of assassins, as do blue fletchings.

## THE END

At noon the door chimes will sound, signaling the arrival of Flaloch's and Alambar's carriages. Raleigh will awaken and immediately seek out any PC(s) he can find to see if the police have solved the mystery. Flaloch and Alambar will go outside and prepare to leave with their carriage drivers. Fleatis (and Mok, if he is still alive) will join them outside and trade angry looks with them for a couple of minutes. Raleigh will suggest that the PCs go outside too (if they haven't already done so), but if no officer attempts to detain them, Alambar and Flaloch will leave no later than 12:10.

If, on the other hand, the PCs confront the NPCs, what happens thereafter will be solely dependent on the player characters' actions. Flaloch will say that he has pressing business back in Kelburn, but may be persuaded to stay a while longer if the characters strongly suggest that they have a solution to the mystery. (The mayor, after all, has not committed any crimes in the last few hours and presumably has no reason to suspect that the PCs may have implicated

him in Liana's death.) But if it seems to Flaloch that the PCs are grasping at straws, he will make another of his comments about police incompetence, promising to instigate sweeping changes in the police department, and will attempt to leave.

Alambar is also in a hurry to leave, claiming that he must return to Jonholm to monitor some ongoing experiments, but he may succumb to pressure from Flaloch if it seems to the mayor that the characters are going to present a legitimate solution.

(Alambar is worried that he may appear to be the guilty party if he insists on leaving while Flaloch is willing to stay and listen.)

Sandar Fleatis is not inclined to leave hastily; he wants to get to the bottom of this affair, and he will spout off angrily at anyone who attempts to leave before matters are resolved.

If the PCs directly accuse Alambar of Romdril's murder and present a case that is similar to what is outlined in "The solution," the alchemist will panic and begin coughing and gasping. He will instinctively reach for his bottle of pills, which of course are not on his person. He will then attempt to cast a spell, but his coughing fit will prevent him from completing it. Then, if he is not physically restrained, he will pull out and drink what he thinks is a *potion of extra healing*, but which is in fact his vial of *oil of acid resistance*. This action will only increase his respiratory problems and render him virtually helpless. In this state, Alambar should be able to be easily apprehended, perhaps with the aid of Fleatis (and Mok) and possibly also with the help of Flaloch, if the mayor has not been accused of any crime. If the PCs have thought to pick up the white pills from the laboratory, and if Alambar is offered one of them to alleviate his coughing, he will regain all of his capabilities and will do everything in his power to escape.

If the PCs directly accuse Flaloch of Romdril's murder, the mayor will demand to see their evidence and, if it is lacking in substance (as it surely will be) he will leave the mansion. If the PCs charge him with participation in the murder of Liana Romdril, and if they have the ledger to prove this accusation, Flaloch will lose his rough demeanor and begin stammering in a futile attempt to cover his tracks. If he is skillfully confronted and interrogated at this point, he will volunteer a full confession. If instead the mayor is physically threatened, he will attempt to resist this kind of treatment, but Sandar, Mok, and Alambar (if the latter has not been accused of any crime) will assist the police in restraining him.

If the PCs directly accuse Fleatis of any crime, he will go pale and quietly deny involvement in any wrongdoing in a manner that makes it almost seem as though he does not believe his own words. This feeling will pass within moments, however, and Fleatis will regain his composure and self-assurance. He will vocally and physically resist any attempt to arrest him. Flaloch and Alambar will support the PCs if they



persist in attempting to apprehend Fleatis, and then both will leave confidently.

If the PCs directly accuse Mok of any crime, his eyes will widen and he will look to Raleigh for help. The manservant and Fleatis will both come to his defense, assuring the PCs that they have made a mistake. If the PCs persist, Flaloch and Alambar will leave.

If the PCs directly accuse Raleigh of any crime, he will become visibly upset and begin to cough again. Fleatis and Mok will come to his aid, the former spewing insults at the PCs for their obvious error and assuring them that they will never hold a job in Kelburn again. Flaloch and Alambar will leave after "congratulating" the officers for their "obvious skill."

If the PCs are unable to legitimately charge anyone with a crime, Raleigh will again succumb to his respiratory damage and Mok, looking disappointed and hurt, will carry him inside. Fleatis will storm off into the woods muttering to himself, outraged that the police are letting Romdril's murderer go free. Flaloch will board his carriage and return to Kelburn, where he

will serve out only part of the remainder of his term before suffering a mysterious fatal heart attack. Alambar will abruptly vanish from his carriage before it returns to Jonholm, having *teleported* far across the continent, never to be seen again.

#### Tournament scoring system

If the Dungeon Master desires, he can rate the players characters according to the following point scale (all points are cumulative):

- + 100 for chagring Alambar with Romdril's murder
- + 50 for charging Flaloch with ordering Liana's assassination
- + 50 for charging Alambar with LeMeurtrier's murder
- + 25 for attributing the servants' deaths to LeMeurtrier
- 0 for letting all the NPCs go free
- 25 for charging Alambar with the servants' deaths
- 25 for each major breach of Kelburn's laws
- 50 for charging Flaloch with the servants' deaths

- 60 for charging Flaloch with Romdril's murder

- 60 for charging Fleatis with LeMeurtrier's murder

- 75 for charging Fleatis with any murder except LeMeurtrier's

- 75 for attributing Romdril's murder to LeMeurtrier

- 80 for charging Mok with the servants' deaths

- 100 for charging Mok with Romdril's murder

- 100 for each murder attributed to Raleigh

Bonus points may be awarded for finesse (or deducted for lack of same). This category includes, but is not limited to, observing standard mystery conventions, such as being exceptionally quick to search in the kitchen cupboard, promptly considering the existence of a wall safe, and revealing the murderer(s) in a "mystery style," such as the way events are described in "The solution." In a multi-group tournament situation, the DM should not award more than 10 points for finesse, nor subtract more than that amount for lack of same. **5**

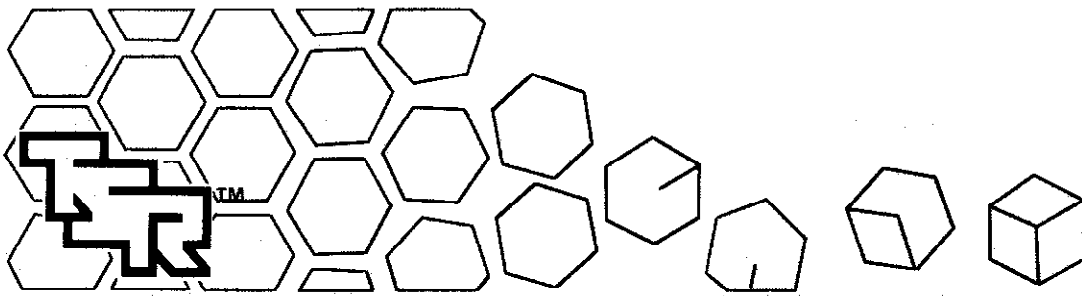

# P R E V I E W S

## NEW PRODUCTS FOR AUGUST 1986

### **DL13 Dragons of Truth** **AD&D® DRAGONLANCE®**

**Game Adventure**

**by Tracy Hickman**

From the depths of the Blood Sea of Istar, the Heroes of Legend embark on a desperate mission to find the secret weakness of the Dark Queen, as the evil Dragonarmies strive to complete their conquest of Krynn! But to learn the Dark Queen's secret, the heroes must seek Paladine, King of the Dragons, in his fabled Glitterpalace — and pass the Nine Tests of Truth!

A prelude to the astounding climax of the DRAGONLANCE® saga . . . which concludes in DL14, *Dragons of Triumph*, coming in October!

**Product No. 9176**

**Suggested Retail Price: \$8.00**

### **DRAGONLANCE™ Legends**

**1987 Calendar**

**featuring the work of TSR Artists**

The magic of the DRAGONLANCE® saga returns in this beautiful fantasy calendar!

Fourteen beautiful poster-quality illustrations from the DRAGONLANCE® saga, by Larry Elmore, Clyde Caldwell, Jeff Easley, Keith Parkinson, and Jeff Butler, will make each month of 1987 a special experience!

**Product No. 8887**

**Suggested Retail Price: \$6.95**

### **IM1 The Immortal Storm**

**D&D® Immortals Set Adventure**  
**by Frank Mentzer**

The first adventure for the new D&D® Immortals Set!

Mighty Immortals from each of the Five Spheres of Power—Time, Matter, Energy, Thought, and Entropy — meet in a desperate battle to obtain the Key to Eternity. Famed designer Frank Mentzer pulls out all the stops in this titanic adventure beyond space and time — don't miss it!

**Product No. 9171**

**Suggested Retail Price: \$8.00**

### **REF2 Player Character Record**

**Sheets (Revised)**

**AD&D® Game Accessory**  
**by Harold Johnson**

Well, yes, we've put out three new hardcovers for the AD&D® game system, and, yes, there have been some character class additions and new proficiency rules, and, yes, your old AD&D® character record sheets are out of date, and, yes, we've done something about it. Sixty-four pages of character sheets completely revised and up-to-date with the very latest in official AD&D® rules, including all new character classes, spells, and combat options from *Unearthed Arcana*, *Oriental Adventures*, and the *Dungeoneer's Survival Guide!*

**Product No. 9028**

**Suggested Retail Price: \$8.00**

### **X11 Saga of the Shadow Lord**

**D&D® Expert Set Adventure**  
**by Stephen Bourne**

The evil Lord of Shadows has captured the mystic gemstone Elvenstar, and with its aid plans to mobilize an army of undead to crush the lands of freedom. Can you foil his sinister plot?

**Product No. 9165**

**Suggested Retail Price: \$10.00**

### **AMAZING™ Stories Anthology 2:**

**Visions of Other Worlds**

**edited by Martin H. Greenberg**

Science fiction writers have long been proposing what life would be like far from Earth. In its sixty-year history, AMAZING™ STORIES Magazine has published some fascinating glimpses, which are collected here. Contains stories by Arthur C. Clarke, Frank Herbert, Poul Anderson, Jack Vance, and Somtow Sucharitkul.

**Product No. 8144**

**Suggested Retail Price: \$7.95**

### **MA1 Children of the Atom**

**MARVEL SUPER HEROES™**

**Advanced Set Guidebook**

**by Kindly Kim Eastland**

The first gallopin' Guidebook for the MARVEL SUPER HEROES™ Advanced Set!

A new, complete compendium of all the Marvel Universe mutant heroes and villains, featuring the Uncanny X-Men™—including everything you've ever wanted to know about their lairs and lives! Plus, a collection of short adventures that make this guidebook ready for instant play! Ninety-six pages of unparalleled excitement!

**Product No. 6872**

**Suggested Retail Price: \$12.00**

All Marvel characters, character names, and the distinctive likenesses thereof, are the trademarks of the Marvel Comics Group. MARVEL SUPER HEROES is a trademark of the Marvel Comics Group. (c) 1986 Marvel Comics Group, a division of Cadence Industries. All Rights Reserved.

### **The Sorcerer's Crown**

**AD&D® Adventure Gamebook #9**

**by Morris Simon**

In the second volume of the *Kingdom of Sorcery* Gamebook Trilogy, Carr Delling, tribal mage of Bukod, resumes his quest For Landor's robe and his powerful crown, begun in AD&D® Adventure Gamebook #7, *Sceptre of Power*.

This book can be played by itself or as part of the trilogy. A special format allows you to move from one book to the next, or to start fresh in any of the books of the trilogy. Continue the adventure in AD&D® Adventure Gamebook #11, *Cash of the Sorcerers*, in December!

**Product No. 8959**

**Suggested Retail Price: \$2.95**

# P R E V I E W S

# P R E V I E W S

## NEW PRODUCTS FOR SEPTEMBER

### **GAMMA WORLD® Game**

by James M. Ward

Eat 18-intensity gamma death, you scummy mutant!

By popular demand, TSR returns you to post-Holocaust America, where mutants battle Pure Strain Humans in a struggle to survive. Join the adventure as you explore the ruins of the old civilization and struggle to understand the strange devices of the Ancients.

This revised edition features a new cover, a new mini-adventure, and an improved combat system.

**Product No. 7010**

**Suggested Retail Price: \$15.00**

### **GW6 Alpha Factor**

**GAMMA WORLD® Game Adventure**

by Kim Eastland

The first of a GAMMA WORLD® campaign series!

You have joined the Restoration Council, a group dedicated to rebuilding civilization. Your party must travel across the ruined country to seek the artifacts that are needed for the Council's work.

But first, you must cross the deadly Burning Lands and the Lip of Despair to recover the memory core of the greatest computer of the ancient world...

**Product No. 7509**

**Suggested Retail Price: \$10.00**

### **Battle Road**

**CAR WARS™ Gamebook #1**

by Steve Jackson

Welcome to the world of 2035 . . . where adventure is everywhere and the right of way goes to the car with the biggest guns.

Steve Jackson, creator of the CAR WARS™ game, now enters the world of gamebooks with the first of a series of exciting solo adventures. The daughter of the President of Louisiana has been taken hostage. Can you drive in alone, rescue her, and get out alive?

**Product No. 8014**

**Suggested Retail Price: \$2.95**

CAR WARS™ & © Steve Jackson Games.

### **The AMAZING SPIDER-MAN™ in CITY IN DARKNESS**

**MARVEL SUPER HEROES™**

**Gamebook #1**

by Jeff Grubb

The first of a new gamebook line by the creator of the MARVEL SUPER HEROES™ role-playing game!

Take on the role of SPIDER-MAN™ as you try to uncover and defeat the sinister mastermind behind a plot to plunge Manhattan into darkness!

**Product No. 8021**

**Suggested Retail Price: \$2.95**

### **19 Day of Al'Akbar**

**AD&D® Game Adventure**

by Allen Hammack

A deadly plague sweeps the desert lands. Only the legendary talisman of Al'Akbar, hidden deep within the tomb of the Sultan Amwara, can cure the ill and lift the curse from the land. . . . but deadly traps and perilous pitfalls guard this ancient artifact.

A module for character levels 10-12.

**Product No. 9178**

**Suggested Retail Price: \$8.00**

### **GDQ1-7 Queen of the Spiders**

**AD&D® Game Supermodule**

by Gary Gygax

Wearied from their long campaign against the Slavelords, the original adventurers from T1-4 TEMPLE OF ELEMENTAL EVIL now must face a new and even more frightening menace: a revolt among the giants of the Drachensgrab Mountains. And from that campaign, they discover that the evil drow elves are once again menacing the surface world . . . and behind the drow is the sinister Lolth, Demon Queen of Spiders!

This new edition of the famous "G," "D," and "Q" modules has been developed and brought up to date, and linked together with T1-4 and AI -4 into a massive single campaign set in the WORLD OF GREY-HAWK™ Fantasy Game Setting.

**Product No. 9179**

**Suggested Retail Price: \$15.00**

### **DRAGONLANCE® Legends, Volume 3**

**Test of the Twins**

by Margaret Weis and

Tracy Hickman

Caramon returns to his own time, only to find Krynn in ruins and Astinus about to close the Great Book. He knows then that Raistlin has succeeded in his evil quest. To defeat him, Caramon and Tasslehoff must descend into the Abyss himself, face the Queen of Darkness, and make certain his brother never leaves. . . .

The final volume of the DRAGONLANCE® Legends series.

**Product No. 8309**

**Suggested Retail Price: \$3.95**

**BOXED GIFT SET of Vols. 1-3**

**Product No. 8313**

**Suggested Retail Price: \$11.85**

### **CAPTAIN AMERICA™**

**in ROCKETS' RED GLARE**

**MARVEL SUPER HEROES™**

**Gamebook #2**

by Kate Novak

Terrorists threaten to destroy the American way of life — unless CAPTAIN AMERICA™ can halt the violence!

**Product No. 8022**

**Suggested Retail Price: \$2.95**

All Marvel characters, character names, and the distinctive likenesses thereof, are the trademarks of the Marvel Comics Group. MARVEL SUPER HEROES is a trademark of the Marvel Comics Group. (c) 1986 Marvel Comics Group, a division of Cadence Industries. All Rights Reserved.

### **Warlords: An ORIENTAL ADVENTURES**

**Gamebook**

**ONE-ON-ONE™ Adventure**

**Gamebook #7**

by David "Zeb" Cook

Prince Sato Matabei, banished son of the deposed Warlord, must battle the Sato Ken-shin, usurper of the throne, with armies of samurai and ninja on every side!

A ONE-ON-ONE Adventure Gamebook for two-player role-playing.

**Product No. 8467**

**Suggested Retail Price: \$5.95**

Unless otherwise noted:

© denotes registered trademarks owned by TSR, Inc.

™ denotes other trademarks owned by TSR, Inc.

Copyright ©1986 TSR, Inc. All Rights Reserved.



## JEFF GRUBB

"I'm just your Friendly Neighborhood Game Designer," says Jaunty Jeff Grubb, fitting the red and black mask carefully over his face. "When I was first gifted with these awesome powers, I used them for personal gain. But when my Uncle Ben was killed by a falling copy of *Advanced Squad Leader*, and I knew I could have prevented it, I learned a lesson that will always remain with me: with great power comes great responsibility."

Jeff Grubb was born August 27, 1957, in Pittsburgh, Pennsylvania. His parents were both school teachers, which caused problems.



"You can't very well tell your parents that so-and-so is a lousy teacher when your father plays golf with him," he said.

While in high school, Jeff discovered an interest that was to prove a major influence in his life . . . games. "I started with Avalon Hill wargames," he said, "and got into SPI™ games later. Some of my favorites were *Panzerblitz*, *Blitzkrieg*, and *Frigate*."

High school was also the scene of another fateful meeting . . . with the woman he was later to marry, author Kate Novak. "She came up to me in the hall one day and announced, 'Your father is Mr. Grubb the teacher!' Of course, I already knew that."

In 1975, Jeff graduated high school. "I was an A and B student. You really had to be if your parents were teachers. I got a C once, which was disastrous." Jeff was also an Eagle Scout. "My best subjects were math, science, and English," Jeff said, "and I wanted to be a writer. But my parents and I both felt that writers generally starve, so instead I went to Purdue University to major in engineering."

In college, Jeff got involved in the comedy show on campus radio, and worked on the student newspaper. During his first year, he got involved with the *Greyhawk™* supplement to the D&D® game, which had just come out. "I first saw D&D being played in the corner of a war-gaming club. These people were sitting in the corner rolling dice and screaming, but there wasn't any board. I went over to ask someone what was going on, but one of the guys yelled, 'We need a cleric!', handed me 3d6, and it was all downhill from there."

He went to his first GEN CON® Convention shortly after he began playing. "I had a

friend who had a house right on Lake Geneva, so the lodging was free. And it was the weekend before school started, so I figured, why not go?"

Jeff began to Dungeon Master his own campaign, Toril, the same year. "The gods of the DRAGONLANCE® world originally came from my personal campaign."

When he came back to Pittsburgh, he brought his D&D® game with him, believing it to be a great way to meet girls. That summer, he talked Kate Novak into joining his campaign, and they began dating, which led to their marriage in 1983.

He graduated college in 1979, with a Bachelor's degree in Civil Engineering, and went to work as an engineer designing air pollution equipment. "It was a glorified vacuum cleaner on stilts," he said.

"I had been volunteered by a friend of mine to write the AD&D® Open for GEN CON one year, and I ended up coordinating the tournament. On the strength of that, I applied for a job with TSR as a game designer, and called every week pestering them for a job. I came up here for a wedding of some friends, and dropped into the TSR Personnel Office. The hiring manager called Al Hammack, who was then Director of Design, to see if he wanted to see me. Al said, 'Oh, what the heck, hire him,' and I joined the company in July 1982."

"My first big project was serving as design consultant for *Monster Manual II*, and right after that, I started the MARVEL SUPER HEROES game. When I was in college, I ran a homemade super hero campaign called the Junior Achievers, with super heroes like the Scientific Swami, the Crimson Ran, and the ever-popular B.M.O.C. So, when the MARVEL game was up for grabs, I grabbed it."



"I worked on MARVEL with top editor Steve Winter, then kept on as project coordinator for the line. I also served on the DRAGONLANCE design team. In addition to the gods, I created Fritz and Macques, the Percheron, and Raistlin's hourglass eyes. I think DL7 is my best work to date."

After the MARVEL Advanced Set, Jeff's next major project is a new AD&D® hardcover, due out next year.

### DESIGN CREDITS

BH4 Burned Bush Wells  
M2 Maze of the Riddling Minotaur  
AD&D *Monster Manual II* (consultant)  
MARVEL SUPER HEROES game  
(and modules too numerous to list)  
DL7 *Dragons of Light*  
AD&D *Unearthed Arcana* (consultant)  
MARVEL SUPER HEROES  
Advanced Set

# Profiles

the TSR art department. She blushed, and consented to be interviewed.

"If you're so normal," we asked, "what is a plastic bust of Mr. T doing on your desk?"

"That's not mine!" she said emphatically. "Well . . . it *is* mine, but it was a gift from somebody else. I didn't buy it. The rest of the staff is strange. I am normal. Normal. Get it?"

"I was born July 7, 1960, in Williams Bay, Wisconsin," she continued. "I had a normal childhood. . . . I was the school spelling bee champion three times in a row. I guess that was the earliest indication that I had the talent to be an editor. I was in the National Honor Society. I was in the chorus, and in the band (I played flute), and in the Pep Club. I was on the newspaper staff — another indication of my editorial inclinations. I was a member of the Student Council. I was even a cheerleader, for goodness sake. Normal. That's who I am. Not one of the weirdos."

"But is it true," we asked, "that you went to the same school as DRAGON® magazine editor Kim Mohan?"

"Well, all right. That wasn't normal, but it *wasn't my fault!* Kim Mohan is also from Williams Bay, which is

become a dentist, so I could inflict pain and suffering on little children and hear their screams and . . . Excuse me. I didn't really mean that. I'm really a nice, sweet, person. And normal. Definitely normal.

"That major lasted a year, then I decided I didn't want to stay in school for the next eight years, so I switched to Marketing — a nice, normal, easy, practical major.

"Marketing lasted another year, then I realized that English was an even easier major — so I kept Marketing as my minor and changed majors again, and finally got a B.A. in English in 1982.

"My first job after college was working at a printing company, where I keylined ads, business cards, and menus, and got interested in graphic design.

"I applied for a nice, normal job at TSR, as an Administrative Assistant with TSR's International Division, but I didn't get it. I did keep in touch with the company, and later that year I got another interview for a job as a Copy Editor. . . and I was hired. Little did I know . . .

"My first real assignment as a Copy Editor was to edit the revised edition of the D&D® Basic Set. I swear, I hardly knew what the D&D game was about. . . and before I knew it, I was stuck with the job of editing boxed set after boxed set, finally finishing with this year's D&D Immortals Set.

"I suppose that's really where I started to go wrong. I was

*Anne Gray McCready*

promoted to full editor after a year, and handled the D&D line, the PARTYZONE™ games, and lots of other projects. I even started to design and develop projects of my own — CB2 CONAN® Against Darkness, X9 Savage Coast, and CM5 Mystery of the Snow Pearls. Well, sure, that's not exactly normal, but I made up for it by designing the ALL MY CHILDREN™ game and the CROSS-CHECK™ game last year. Now, I'm working on RS1, RED SONJA™ Unconquered.

"With game designing and a carefree life as a bachelorette in exciting Lake Geneva, my life had become a little less normal, but it turned around. In classic matchmaking style, my mother and one of her friends set me up with a date with Ben McCready just after Christmas 1984, and we were married the week before GEN CON. This year, I'll be spending my wedding anniversary at GEN CON, and I hope you appreciate it."

We assured Anne that yes, we appreciated it, and asked her if she had any normal advice for our readers.

"Well, yes," she said. "Learn how to type. It is the most important single skill you can have, no matter what field you are in."

"Is that all?" we asked.

"Oh, yes," Anne added. "Seat belts save lives."



ANNE GRAY McCREADY

"Oh, do I really have to do this?" Anne said, when the TSR PROFILES interviewer entered her office. "I'm basically a normal person, unlike all these other people. I didn't wake Gary up by pounding on his door like Jon Pickens, I don't collect Japanese robots like Zeb Cook (even though I have a model of King Kong climbing the Empire State Building on my desk), or anything!"

We assured Anne that yes, indeed, it was her turn to bare her soul to the readership of DRAGON® magazine, and threatened to reveal that she had served as a model for

a very small town. My dad was one of his teachers, and his sister was my babysitter when I was a child. But I didn't really know him, so it doesn't count. Every small town has someone abnormal, and Kim was it. Not me! I was completely, absolutely, positively normal. I played sports, like basketball and volleyball and softball. I even went on a concert tour of Europe for a month. Now, is that normal, or what?"

"When I graduated from high school," Anne continued, "I went to the University of Wisconsin at Whitewater, and started out majoring in biology. At that time I wanted to

# Pull the pin and throw

## Grenades get more detail for TOP SECRET® play

by Kevin Marzahl

Contrary to popular belief, grenades are not powerful enough to blow out the side of a building — an outhouse, perhaps, but nothing like a well-built office complex. However, grenades have more uses than blowing things up, as will be shown later. A brief history of the hand grenade follows, with a discussion of the different types of grenades, how they function, and how to use them in the TOP SECRET® game system.

### History

Webster's New World Dictionary defines a grenade as "a small bomb detonated by a fuse and thrown by hand or fired from a rifle." This certainly applies to the hand grenades of today, but the first "grenade" used in history was probably a clay pot filled with poisonous snakes, burning oils, or acids, and thrown by hand at an enemy. Such primitive grenades most likely originated in the Far East with the barbaric Mongols. They were also used in Medieval sieges.

Grenades reappeared during the American Revolutionary War. Black powder was used as an explosive in grenade form, though its use was primarily limited to the bombing of the riggings and powder magazines of British ships. Grenades were improved during the American Civil War, as powder delay fuses were added.

Not much more happened with grenades until World War I. Here came an explosion of grenade designs, stemming from the peculiarities of trench warfare. However, most of these grenades did not get far and, in World War II, warring countries fell back on the tried and true grenades of World War I. Most of these were forms of the fragmentation grenade. For the British, it was the Mills Bomb; for the Germans, it was the famous "Potato Masher" stick grenade, drawing its unusual name from the kitchen utensil it resembled. World War II also marked the birth of the white phosphorus, or WP, grenade, which hurls particles of burning chemical upon explosion. Since then grenades have been improved and specialized. What was once a military tool has found its way into riot control and even espionage.

### Functioning

The different types of grenades all share four common characteristics:

1. Range
2. Effective Casualty Radius (ECR)

3. Knockdown Radius (KDR)

4. Time Delay Fuse (TDF)

Range depends upon the weight and shape of the grenade, as well as the thrower's ability. The ranges for individual grenades that are listed on the Grenade Table in Part II are the ranges that the grenades are best suited for, although all grenades can be thrown a maximum of 100'. A character's chance of hitting on target with a grenade is inversely proportional to the range. A character would have a 95% chance of being on target at a range of 5', and only a 5% chance of being on target at 95' away. If the grenade is thrown within the range listed on the Grenade Table, add 8% to the character's chance to hit on target. The maximum percentage chance to hit a target cannot exceed 95%.

Effective Casualty Radius (ECR) is the radius of an area around the point of detonation within which exposed personnel become casualties.

Knockdown Radius (KDR) is the radius of an area around the point of detonation within which the Stopping Power Rules should be applied (see the TOP SECRET Companion, page 41-42, or DRAGON® issue #49, page 24). As a general rule, all grenades and 40mm ammunition will incapacitate an unprotected human target.

Time Delay Fuse (TDF) is the length of time between the ignition of the primer and detonation.

In addition, all grenades share a common assembly consisting of three basic parts:

1. Fuse Assembly — The safety lever, safety pin, striker, primer, delay element, and detonator or ignitor.
2. Body — The container that holds the fuse assembly and filler.
3. Filler — The substance with which the body is filled: chemicals, high explosives, or gas.

The manner in which these three parts function together is quite simple. As anyone

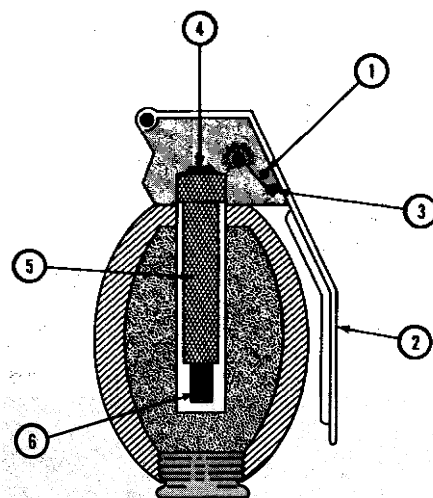

knows, all one must do to use a grenade is pull the pin and throw. But what happens in between these actions and the explosion?

First, the pulling of the pin. In the accompanying diagram, the pin would be placed through the hole (1). After the pin is pulled, one would normally throw the grenade. However, if you pull the pin and don't throw the grenade, the device will not go off in your hand. The reason for this is that the pin is merely holding the safety lever (2) in place. The lever, or "spoon" as it is sometimes called, is holding the striker (3) in place. Once the thrower lets go of the lever, the striker, powered by a small spring, moves to hit the primer (4). The primer, in turn, activates the delay element (5). After the delay element has finished burning, it activates the detonator or ignitor (6), which causes the grenade to go off.

### Grenades and launchers

What kind of grenades can agents obtain, and what can they do? The table below lists the grenades described in this article, their four characteristics, damage (explained in detail under the grenade descriptions), and

Type	Range (feet)	ECR (feet)	KDR (feet)	TDR (seconds)	Damage	Weight (pounds)	cost (\$ U.S.)
Fragmentation	80	40	5	4-5	special	1	20
White phosphorus	70	55	5	4-5	"Z"	2	50
Concussion	70	20	10	4-5	special	1	15
Thermite	60	—	—	2	special	2.5	35
Smoke	70	—	—	2	—	1	10
Gas	70	special	15	2	varies	1	20
Flare	80	—	—	7	—	1	15
Stun	60	—	special	.5	special	2	100

# GAMES ON CALL™

- Call-in Convenience
- Fast, 24-hour Shipping
- No Shipping Charge in US (\$1.50 handling fee per order)
- Large Selection
- Credit Cards Welcome
- CODs Welcome
- Express Service Available

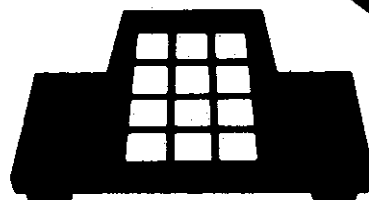

**1-800-874-7907**  
TX & FOREIGN 1-806-358-3270

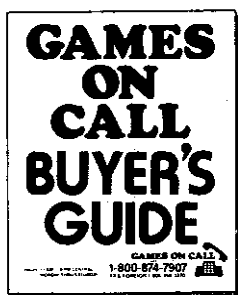

**CALL OR WRITE NOW for  
FREE BUYER'S GUIDE**

**New Summer '86 Edition Now Available!**

## **DELTA FORCE**

*America Strikes Back!™*

**BEST OF THE BEST**

**Join *Delta Force*...**

**Strike Back for America!**

**DELTA FORCE — The role-playing game of an elite anti-terrorist commando unit.**

*Designed by William H. Keith, Jr.*



**TASK FORCE GAMES, 1110 N. Fillmore, Amarillo, TX 79107**

**TASK  
FORCE  
GAMES**



individual hand-grenade costs and weight. All grenades may be bought as a thrown bomb or a 40mm launched round.

### Grenade descriptions

**Fragmentation (FR):** A standard "frag" grenade is usually round and smooth with a serrated body. Upon detonation of the filler (usually a high explosive), the body and fuse assembly are hurled in all directions, becoming lethal projectiles. As per the rules in the TOP SECRET rule book, fragmentation grenades do 12 points of damage to anyone within 10' of the explosion, 3 points to anyone 11-20' away, and 1 point to characters 21-40' away. This may seem rather weak, but is perfectly realistic. Holding an exploding frag grenade causes 24 points of damage. Jumping on a live grenade results in the shielding character taking the full 24 points. This grenade is based on the M26A1 and M67 hand grenades, both used by the United States Armed Forces.

**White phosphorus (WP):** The WP grenade is cylindrical, tapering toward the bottom. The body, like that of the frag grenade, is serrated for easy break-up. Upon detonation, it throws particles of burning phosphorus an average distance of 50', though some pieces may go as far as 60'. Damage from WP grenades does not decrease with range, since damage depends not upon velocity (as in the frag grenade), but upon the burning of the chemical. Damage can be calculated using the "Z" HTH combat table found on page 29 of the TOP SECRET rule book. A WP grenade also produces a white screen of smoke (treat as a smoke capsule). This grenade is equivalent to the 40mm incendiary shell in the, TOP SECRET Companion.

**Concussion (HE):** This grenade is the equivalent of the "blast" grenade found on page 35 of the rule book (and clarified in DRAGON issue #67, page 13) or the high-explosive shell found in the Companion. It is based on the Mk3A2 and is a pre-packaged high-explosive charge in a fibre-board casing. The casing does not cause fragmentation damage, but "blast" does occur (i.e., enormous shock waves which stun and knock characters to the ground). The damage is calculated as in the rule book, but the damage is considered non-lethal, as this grenade is meant to incapacitate, not kill.

*[It is assumed that the concussion grenade is not the same sort as the stun grenade described below. If desired, referees may combine the statistics of these two grenades, using the additional effects noted for the stun grenade (deafness, paralysis, and loss of Coordination) for the concussion grenades. — Editor]*

**Thermite (TH or INCEN):** This is an example of a specialized grenade. It is cylindrical and made of sheet metal. When the delay element ignites the filler or magnesium oxide, the mixture burns for about eight turns (40 seconds), reaching a peak temperature of 4,300°F. This molten ther-

mite flows from emission holes on the top of the grenade; it does not explode. The mixture will melt through a half-inch of steel as well as asbestos walls and safes, setting the contents of a safe afire. It will weld machinery parts together as it flows between them. Any character unfortunate enough to come into contact with the thermite while it is burning suffers 10 points of damage per phase for up to five phases, or until he is no longer in contact with the mixture. If a character is within 5' of the mixture, he will suffer five points of heat damage per phase for up to five phases or until he is a safe distance away.

**Hexachloroethane smoke (HC):** These grenades are cylindrical and contain colored smokes used primarily for signaling. Available colors are red, orange, yellow, green, blue, purple, violet, white, and black. No smoke appears during the turn that the grenade lands; in the next five turns, a cloud of smoke will appear, extending downwind. The cloud will disappear over a period of two to three minutes.

**Gas (GAS):** These grenades contain anesthetic, tear gas, mace, sleeping gas, or poison. These five types of gas will all take the form of a 15' x 15' cloud. Anesthetic, tear gas, mace, and sleeping gas are colorless. All but sleeping gas have an odor. Their effects and durations are found on page 39 of the TOP SECRET rule book. Poison-gas grenades come in all six types listed in the rule book and cost the same as one dose of the appropriate type of poison; all other gas grenades cost \$20 each.

**Illumination flare (IF):** This grenade, as do the rest in this article, comes in two types: a hand-held grenade and a 40mm round. In this case, the round is much more effective. The flare grenade is not usually thrown, but is dropped or rolled. After the delay element has finished burning, the base of the grenade is blown off. This reveals the burning filler which produces a very bright light over a 50'-radius area, lasting 30 seconds. Looking directly at the light causes temporary blindness for 1-6 turns, reducing Coordination by 1-100% until the effect wears off.

The 40mm launched rounds are fired from one of the launchers described in this article. The round is shot into the air and slowly descends on a small parachute. While descending, it casts a light over a 30-yard radius, but is visible for 3 miles over still water and slightly less over land. A flare at the maximum height of 600' is visible up to as far away as 33 miles over a calm body of water. These flares come in red, yellow, green, and white, and they are used for both signaling and illumination.

**Stun (ST):** So far, no official statistics are available on this type of grenade. The description below was drawn from fictional accounts found in numerous espionage and adventure novels. This is, however, a real grenade, and an excellent reference to it is found on page 295 of *The Devil's Alternative*, by Frederick Forsyth. Readers are also directed to recent James Bond novels by

John Gardner for other descriptions of the grenade.

This is a very sophisticated and expensive device. It has found its greatest use in anti-terrorist operations, particularly by the British Special Boat Service (SBS) and its sister organization, the Special Air Service (SAS). Almost immediately after these grenades are thrown, they explode with a blinding flash. For game purposes, this results in temporary blindness lasting for 5d10 turns. The grenade also gives off a tremendous "bang" at the same time. This "bang" has a 90% chance of blowing out the eardrums of an unprotected human target (eardrums will heal over a period of 1-6 months) and will automatically cause an instant loss of concentration and partial hearing loss. In all, the flash and bang reduce the Coordination of a character by 1-100 + 50% for 1-5 minutes. In addition, if a victim's eardrums are blown, a tonal sound (the "crash") enters the middle ear and causes a 10-second paralysis of one's muscles. Because this grenade is quite powerful, the Administrator may wish to make it difficult for agents to obtain.

All grenades are marked according to their type and are lettered to indicate their fillers. These letters are shown in parentheses beside the titles of the grenades in the above descriptions. Body and letter colors are as follows:

Concussion and fragmentation — olive drab with yellow markings

Gas and chemical — gray or light green with black markings

Dummy (training) — black with white markings, or blue with black markings

Smoke (HC) grenades have a colored band around their middles, depicting the color of the smoke they produce.

### Grenade launchers

Grenade launchers obviously have no place in true espionage. However, the TOP SECRET game also encompasses short, commando-style raids, such as in module TS 002, *Operation: Rapidstrike!* Therefore, agencies have made three types of grenade launchers available to agents participating in such assaults: the M-79, the M-203, and the Mark-19.

The M-79 is a hand-held 40mm launcher. It takes grenade rounds as well as the 40mm ammunition given in the TOP SECRET Companion. It is a break-open, single-shot launcher with a wooden stock.

The M-203 is a weapon-mounted grenade launcher and uses the same statistics as the M-79, because they are essentially the same weapon but carried in a different fashion. The M-203 is designed to fit the M-16 assault rifle in the standard under-over configuration, although it will fit any assault rifle with some minor modifications. It is a single-shot, breech-loaded, pump-action launcher that comes with a quadrant sight assembly that must be attached to the rifle.

The Mk-19 is an infantry-support weapon, generally vehicle mounted, though

# FIRE SALE!



Subscribe to

# Dragon<sup>®</sup>

Magazine

## while it's hot!

No, we're not going out of business — in fact, we're more fired up than ever! DRAGON Magazine is 10 years old this summer, and we've decided to celebrate by giving you a special opportunity to subscribe to the world's biggest and best role-playing game magazine. If you order a subscription — a new one or a renewal — between now and Aug. 31, you can get 12 issues of DRAGON Magazine for only \$24 instead of the regular price of \$30. That figures out to just \$2.00 per issue — a bargain you can't afford to pass up!

Use the reply card in this issue of DRAGON Magazine to order, or simply send your name and address along with payment in advance to TSR, Inc., P.O. Box 72089, Chicago IL 60690. Just be sure your order is postmarked by Aug. 31, and then settle back and let us do the rest!



Weapon	PWV	PB*	S	M	L	WS	Rate	Ammo	cost	Decp	HWV
M-79	53	—	-45	-145	—	BA	1	1	350	NC	14
M-203	53	—	-45	-145	—	BA	1	1	350	NC	14
Mk-19	73	—	-38	-130	—	BA	3(1)	50(1)	500	NC	NA

\* — Launchers may not fire at point-blank range, since the round needs to build velocity or it will not detonate.

a tripod will do. This weapon takes belted 40mm ammunition or single rounds, depending upon how much firepower the agent wants. This is a powerful weapon and should be used only by experienced agents on dangerous missions.

In general, grenade launchers give agents the advantage of greater range and accuracy. The maximum range of a launcher is 800'. The statistics for the weapons assume that the character has taken the time to calibrate the sight for range, trajectory, etc. Launcher ammunition may be set to explode at a set altitude or upon impact. Ammunition set to explode at a specific altitude must be purchased with said altitude specified upon purchase; altitude may not be adjusted during a mission. The maximum altitude that a launcher will fire is reached at medium range.

All military projectiles are 40mm and fired from one of the above-described weapons. When using ammunition of such high caliber, there are two modifiers not used with thrown grenades. These are the Damage Modifier and the Vehicle Damage Modifier. The Stopping Power Modifier is used with both grenades and 40mm ammunition.

**Damage Modifier (DM)** is applied on a direct hit. The number on the chart below is equal to the number of injury points that should be added to the normal damage suffered by a character and is applied within the ECR.

**Vehicle Damage Modifier (VDM)** is applied when 40mm ammunition is used against vehicles. Add the appropriate modifier to the dice roll before consulting the Bullet Use Against Vehicles Table found on page 38 of the rule book.

**Stopping Power Modifier (SPM)** is used to determine if a character is incapacitated according to the Stopping Power Rules found in the TOP SECRET Companion, or on page 24 of DRAGON issue #49.

Type of round	DM	VDM	SPM
Fragmentation	+10	+80	120
Gas	+13	+30	480
Concussion	+31	+240	1560
Illumination	+16	+60	720
Incendiary	+16	+120	840

#### Scatter

Regardless of whether a character throws or launches a grenade or 40mm round, the

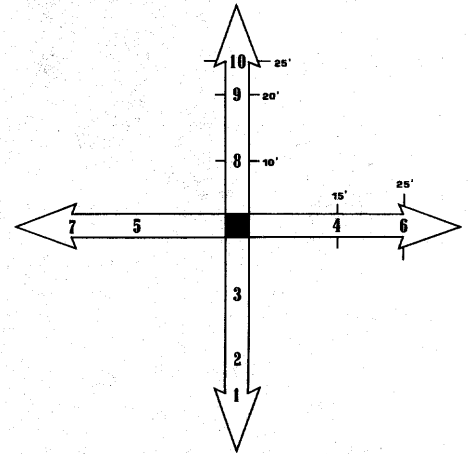

projectile must go somewhere if the character misses his intended target. The accompanying diagram is a pictorial form of the information given in the rule book. When a character misses, roll 1d10 and consult the diagram. If a character misses his target, but it remains stationary, add 5% to his chance to hit on his next throw or shot.

#### Booby traps

Grenades do not have to be thrown or launched. There are numerous documentations of booby traps involving grenades. In some cases, the pin was pulled, but the safety lever was held down. The grenade was then placed under a dead body or similar object. When the object was lifted . . . BOOM!

It is also very simple to secure the grenade to a post or tree and attach a sturdy line to the pin. The line can be drawn across a path at ankle level. When this trip line is pulled, the grenade will go off.

Whether a grenade is thrown, launched, or used as part of a trap, it is a useful tool limited only by the imaginations of the agents.

5

## SOME REFUSE TO DIE in the AFTERMATH!



AFTERMATH! is a role-playing excursion into a post-holocaust world for 2 to 6 players and a referee in search of a different kind of adventure

- Basic Rules book with multiple examples of play.
- Players' Handbook detailing character generation, equipment, and life after the Ruin.
- Referee's Handbook detailing construction of the environment and running the game.

AFTERMATH! provides for modern firearms, NBC weapons and protections, mutations, survival, high technology and more. The game is structured to allow the referee to decide the nature of the holocaust that destroyed civilization in the world in which play will occur. The boxed set also includes an introductory adventure, character sheet, and judge's screen with the three volumes of rules. AFTERMATH! is a step forward in the art of role-playing games. \$24.00

#### ALSO AVAILABLE:

- INTO THE RUINS: the city of Littleton. Adventures 20 years after the ruin. . . . \$6.00
- OPERATION MORPHEUS: a university setting some 100 years after the Ruin. . . . \$8.00
- SYDNEY: THE WILDERNESS CAMPAIGN: an entire city campaign pack. . . . \$7.00

CAN YOU SURVIVE?



Available from better shops worldwide, or direct from Fantasy Games Unlimited at P.O. Box 182, Roslyn, New York 11576. Please add \$2 for postage and handling. New York residents, please add appropriate sales tax.

### Label your letter

The address of DRAGON® Magazine is P.O. Box 110, Lake Geneva WI 53147, and that's all you need to make sure your letter gets here. But you can help us serve you more quickly by adding a line at the top of the address to tell us what department should receive your letter or package. Call it a "manuscript submission," "cartoon submission," "query letter," or any other short phrase that tells us what's inside, and it'll get exactly where it's supposed to go.

# When it comes to dungeon design, we have a lot to offer

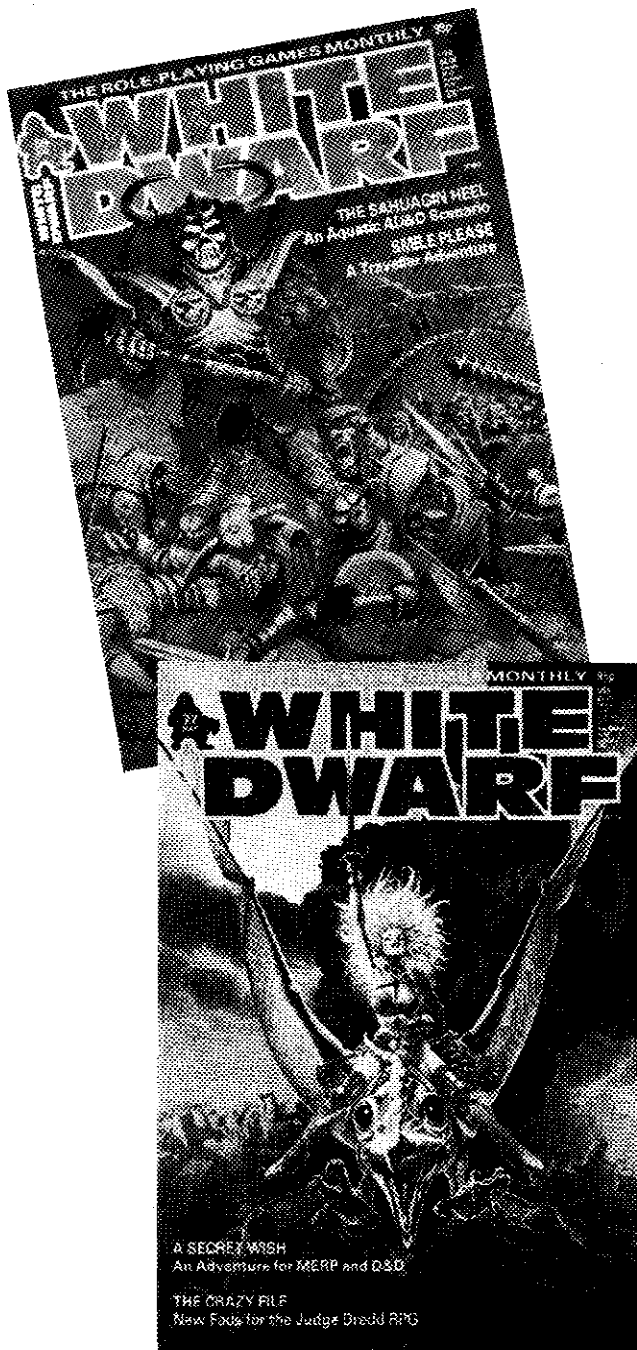

We've been building castles in Britain for over 900 years. The country is steeped in legend, myth, and history. It is not surprising, therefore, that scenarios in **WHITE DWARF** are praised for their realistic atmosphere and content. And it is hardly surprising that **WHITE DWARF** wins so many awards. **WHITE DWARF** is the leading British magazine dedicated to role-playing games such as **Advanced Dungeons & Dragons**®\* fantasy adventure game, **Runequest**®, **Warhammer**, and **Traveller**®. Each month it features articles, scenarios, reviews of miniatures and games, letters, and our own comic characters Thrud the Barbarian and Gobbledigook. The increasing demand has enabled us to realize significant savings on production costs. We are passing these savings on to YOU!

NOW ONLY  
**\$1.95**

Place an order today at your local game store, or send \$18.00 for a 12 month subscription—a fantastic saving of almost 25% off the cover price. Write to: **Games Workshop (US), 8920 Route 108, Columbia, MD 21045.**

\*Advanced Dungeons & Dragons® is a registered trademark of TSR, Inc. RuneQuest® is a registered trademark of Chaosium Inc. Traveller® is a registered trademark of Games Designers' Workshop.







he met him, as she had always dreamed she would meet her Mr. Right, in the university library where she worked. Dismissed for improper use of backbone by her supervisor, Mr. Ballard, from her post beneath

Our Lady of the Circulation Desk — a mural of churchly appearance, provenance unknown — she was doing penitential stack-work when their paths first crossed.

Like many a Yale student too lazy to make a selection from the shelf and go seeking an unoccupied carrel in which to read it, he sat on the floor at a dead-end narrow aisle between two rows of stacks. Legs drawn up into a flat-footed squat, at first glance his posture and occupation were old hat to any experienced librarian.

The old hat was squashed past recognition at second glance.

Naked, muscled like statues that made her nervous, skin aglow with healthy sweat and surrounding atmosphere pungent with the same, he was reading a back issue of *National Geographic* and blubbering. A deflated wineskin lay beside him, a little liquid still dripping and dribbling from the narrow neck to make a tiny puddle on the floor.

And of course there was the matter of the sword, a hefty double-edged blade whose long hilt demanded two hands to wield it. The miniature golden skull on the pommel gave her a saucy wink of diamond eyes.

Charlene shook in her Cobble Cuddlers to think what Mr. Ballard was going to say about all this. In an undertone she thanked her stars that she wasn't the one on stack-access duty today. If this person had a Yale student I.D., she was a rutabaga.

(Less kindly things had been said of Charlene Atwater, but all from the lips of unsatisfactory blind dates who were only after one thing.)

Softly, with the discretion of a lifetime of sensible, rubber-soled shoes, Charlene began backing the cart out of the aisle. Prudence guided her to duck her ash-blond head out of sight behind a quarto volume of Western European costume plates as she made her retreat.

A wise move, as it turned out. Though she was departing even more silently than she had arrived, circumstance was capricious. She heard a snort, a guttural cry of astonishment, the scuffle of bare feet on the stone floor, and a skin-tingling yell. Something went *whoosh* through the air, *thunk*, and the book cart slammed into the top of Charlene's bowed head with enough force to rattle her teeth and knock her off her Cobbies.

"Who are you?" The voice was a roar in her ears that made painful afterimages of blue and orange light bursts across her eyes. "Speak!"

Slowly, Charlene sat up, rubbing her crown. For some reason this made the whole back of her skull throb. The stack-cart was gone, but she knew it had been there only a moment ago. It had bowled her over splay-legged, in such a suggestive manner that Mr. Ballard would have had the giggles for a week. But where was it now. . . ? She looked left, right, and over one shoulder before she was rewarded with success.

A pile of flinders and gracefully revolving casters

# File Under "B"

By Esther M. Friesner

reposed on end, propped up by a barrow of unshelved books. From one remnant of the wrecked cart a black iron mace protruded, spiky head deeply imbedded in the soft wood. Here was a basic how-did-it-get-there problem. The library aisle was so narrow that there was no way Charlene's newfound *Geographic* fan could have wheeled the cart around her; and had he chosen to wheel it over her supine body, she would have known about it — she wouldn't have been surprised, but she would have known.

Which meant it had been tossed; just hefted up and tossed lightly overhead the length of the aisle.

Charlene made a grimace at the thought of explaining all this to Mr. Ballard. Her supervisor never did care for jocks let loose to root among the books. He was ticked enough with her already. He had sent her into the stacks for daring to snap back at a full professor who insisted that the volume he wanted *had* to be in the 800s and it was all her fault that it was not.

"A place for everything and everything in its proper place," she had told him. "That is the only sensible way to run a library." When she produced the errant volume and triumphantly pointed out the 300 classification on its spine, the man had complained.

Damage to the egos of tenured faculty was a misdemeanor, damage to library property a mortal sin. Mr. Ballard — and her own tidy soul — would demand justice, or at least retribution. She returned her attention to the perpetrator. At least he wasn't naked any more. He never had been, really. Charlene blamed his former crouching posture and her own myopia for allowing her to overlook the blessed scrap of chamois dangling fore and aft between his thighs.

She twisted the top button of her blouse for luck and said, "I am Miss Atwater, young man. I'll have to ask you for some identification."

She gave a little squeak as he thrust the skull-decked hilt of his sword an inch from her nose. Blue eyes narrowed, face a study in concentration, he traced a seemingly senseless pattern of swoops and curlicues in the air before her face. She only flinched twice, when he jabbed the golden skull at her eyes. He snorted again, nodded, and sheathed the sword, satisfied.

"I'm afraid that won't do, young man," Charlene said when she felt able to speak.

He ignored her. "Not one of *his* sendings. Good. Get up, woman."

"Young man, I must insist."

He gave her no chance to insist on anything. "I said get up!" He seized her wrist and gave it a playful tug that converted her from grounded to airborne in a whip snake's flick. She rebounded from his chest before landing on her feet. The fleeting contact was very warm and . . . not subject to immediate classification.

Charlene had trouble dealing with ordinary people. She was one of those poor souls that unprincipled tradesmen gloat over as they heartlessly cancel appointment after service-call appointment at the last minute, only to hear *her* apologizing profusely to *them*. Still, even the meek are human, and subject to the corrupting influence of power — more so than others, actually. It is an intoxicant that affects the novice worse than the habitué. In the outer

world, she might be nothing and no one, but here in the stacks with the whole weight of ALA backing her, she was Authority! (Barring the unscheduled arrival of Mr. Ballard.)

She pushed herself away from the swordsman and drew her shoulders back. "If you don't show me some acceptable identification at once, I am going to phone Security! You don't belong here, and I am going to see to it *personally* that you get out!"

She might get her head cut off, but she had done her duty for God, for country, and for Yale.

Instead of a casual lop of the sword, Charlene found herself in receipt of a nose-squashing hug that brought tears to her eyes — not that she was sentimental, but the impact dislodged one of her contact lenses. As she fumbled it back into place, she heard a stream of oaths invoking the names of a whole pantheon of exotic gods.

She assumed they were gods. The jumbled syllables sounded like the names of generic antihistamines, and this fellow was definitely not Yale Med School material.

"Beautiful lady, gracious goddess, blessed wench!" the Med School reject cried, kneeling at her feet with the sword a comfortable distance away. "Your wisdom pierces *his* malice! Yes, yes, who but a sorceress of the highest power would be able to tell at a glance that I *don't* belong here! Who but a goddess would have the boundless mercy to promise that she will get me out? *Personally!* The words of the Oracle of G'narchuk are fulfilled! *Into an alien world shall your enemies cast you, seeking your death, yet there shall a different death be found!* By Limbranol's spear, we'll give that demon-cursed wizard a surprise!"

Here he embraced her knees. Then, abruptly, he was on his feet and ready to discuss barbaric bottom lines. The skull-hilted sword was again in his grasp — Charlene watched awestruck as he flourished the two-handed blade with one hand only — which gave him a certain bargaining power that the School of Organization and Management never covered in its seminars.

"Well, wench, what's your price?"

"I *beg* your pardon!" Charlene tugged her straight twill skirt even straighter.

"What do you want from me?" he amended.

"Exactly what I've been requesting for the last half an hour, young man: your name, thank you very much."

The young man (not much older than Charlene herself, although by a calendar based on three moons, a red sun, and the mating cycles of wingless dragons) rubbed his deeply cleft chin thoughtfully with his wrist. It was the wrist attendant on his sword-hand, and the gesture brought the blade dangerously close to his own neck.

"My name. . . A weirding of great power, or I'm a grig. Yes, I have heard of such debts. To name is to own, yet what can I do? You are my only hope of seeing home again and washing my blade in Cambrac's blood. My name . . ." He grunted.

"Yes, if you don't mind," said Charlene. "Give me your name." She was relieved to see that the interloper was at last cooperating, even more relieved when he lowered that sword. Half-naked warriors in the stacks might be explained, given enough time, but if this one were

careless enough to commit accidental suicide . . . "I'm waiting, young man."

"Waiting for what? You have your price. In my land, few men hear a warrior's blade-name and live." He made a sound like a cranky bear. "There! Must you have it again, woman? Three times three, to work a spell that will enslave me to you forever?" He repeated the ursine sound nine times and got a minor nosebleed.

"You mean . . . that grunting noise. . . ?"

The man looked proud. "Only the third to have earned that name among my tribefolk in twenty generations! There, I have fulfilled your demand, now you must fulfill mine!"

Charlene felt that she had been here before, with the difference that this fellow had not yet bought her dinner, although he was a sight better-looking than her last blind date. Still, he was clearly only after one thing, and she *was* a lady.

"The runes! The runes of return! What, was my name not enough to purchase them?"

Charlene took a long cleansing breath of the sort her therapist recommended. Then, having mastered her emotions, she said, "My dear Mr. —" She grunted.

He wrinkled his nose in disgust. "Easterners' accent! Faugh! Even in this distant plane it haunts me."

"I am doing the best I can, Mr. —" Another attempt.

Another grimace. "Eastern ears . . . only good for hanging rings from," the mispronounced warrior grumbled. "Or collecting to dry." In a louder voice he added, "They call me Bonemaker in the legends."

"Mr. Bonemaker, I think we could both use a drink."

"Ha! Now you make sense." He turned to kick away the empty wineskin. "Strong drink to charge your spells with might and fill my sword-arm with power. And then

. . . *death to Cambrac!*"

"Lower your voice *this instant!*" Charlene hissed. With a self-assured toss of her head she added, "*This is a library.*"

Sometime later in the basement snack bar, wrapped in a janitor's coverall that Charlene had managed to snag for him, Bonemaker became simultaneously acquainted with decaffeinated coffee and despair.

"You mean . . . you're not a sorceress?"

"I am a librarian. I take care of books. You do have books where you come from, Mr. Bonemaker?"

In mute pain he nodded, then said, "And this . . . is not a powerful wizard's stronghold? A warrior-king's castle? The lair of fabulous monsters that can leap from one world to the next if a man has the wit and sinew to tame them?"

Remembering how she had found him in tears, Charlene reached across the table and patted his hand gently. "Only under 'F,' Mr. Bonemaker; for 'Fiction.' "

"Under where?"

"In the card catalog." She saw that he was giving her a look similar to one she'd given him on learning that his name was best pronounced by a dyspeptic grizzly. "Where we keep track of the books: which ones we have, where they are, when they were published, title, subject, author . . . Whatever you want to know can be found in the catalog."

Bonemaker crushed his cardboard cup, sending Sanka squirting. Charlene was still wondering whether it would leave permanent stains on twill as he frog-marched her up the stairs to the first floor where the vast card catalogs of Yale awaited.

"Find them," he growled in her ear. She could feel the insistent prick of a dagger blade in the small of her back. For a man who had showed up in her dimension with so little to wear, Bonemaker had managed to conceal an extraordinary amount of armaments on his person. "Find the runes of return."

"Now listen, you are clearly out of your mind," she whispered back. "I am a librarian, not a miracle worker!"

"You said that whatever I wanted to know is here. *Find them!*"

The dagger jabbed a little deeper, making her yip. One of the many students huddled at the high tables near the catalogs looked up. "*Shhhhh!*" he said.

"Find the runes of return," Bonemaker pressed. "Seek them where you seek the monsters, in the place called Undereff."

"You just won't understand, will you? 'F' is for *Fiction*. Runes of return would be under 'R' for — well, for 'Runes.' Or possibly 'Return.' But I assure you, you aren't going to find any such things in Sterling Memorial Librar— ee! "

Bonemaker lodged a rather pointed argument.

With a sigh and a shrug, Charlene said, "Fine, fine, don't take a trained librarian's word for anything. I suppose you've got tenure too, wherever you come from. We shall look under 'R,' but I'm warning you . . ."

She was a woman transformed by revelation (also under 'R') when she lifted her head from the rack of cards and



breathed, "It can't be."

She looked again.

"But it is. It's here. It's in the 600s, God knows why, but — Oh, come on!" She seized Bonemaker by the wrist, well above the dagger, and yanked him after her, pounding for the bank of elevators that would fly them to the stacks.

The grad student earning a part-time pittance on stack-access duty tried to stop the two of them for I.D. "Barbarian warriors don't go to Yale!" Miss Atwater shrieked in his face, and beamed him with the handle of her large companion's umbrella.

It had to be an umbrella.

It could be nothing else, and the grad student still remained adjudged relatively sane.

An umbrella. Of course.

If so, in a distant land the evil wizard Cambrac met his long-deserved fate impaled on the enchanted blade of Bonemaker's skull-hilted . . . umbrella.

This denouement came about only after a lengthy, spec-

tacular battle of sorcery. Evil wizards are seldom gutted without some fuss and a lot of magical preliminaries. In the songs that later bubbled up out of Cambrac's cooling innards, the bards sang of how Bonemaker's lovely female ally single-handedly destroyed wave after wave of the wizard's hell-spawned familiars. To this end — though it never quite made it into the songs — she employed the same reference volume which had transported them to Cambrac's den in the first place, viz.: *Runes for All Reasons* (Unabridged). The index alone was indispensable.

When the dust settled and the ichor stopped spurting, Bonemaker gave his full attention to Miss Atwater. Her hair was a mess, her twill skirt in tatters, and her Cobbie Cuddlers lost somewhere between dimensions. However, her contact lenses were still secure, and the recent excitement and exercise had done wonders for her color and chest expansion.

Soulfully grunting the blade-name he had chosen for her, Bonemaker took her in his arms. He was clearly only after one thing. She let him have it.

AC 6 A DUNGEONS & DRAGONS® Game Accessory 9037

**DUNGEONS & DRAGONS®**  
Official Game Accessory  
Now on the NEW BACK FLIP! COMPLETE FOR PLAYERS AND MASTERS!

With the revised official D&D® Player Character Record Sheet package. Individual sheets for all official character classes give you ample room to list all stats, spells, and equipment . . . all the way through the Master level!

**TSR™**  
TSR, Inc.  
PRODUCTS OF YOUR IMAGINATION™

DUNGEONS & DRAGONS, D&D, PRODUCTS OF YOUR IMAGINATION, and the TSR logo are trademarks owned by TSR Inc. ©1986 TSR Inc. All Rights Reserved.



# Ares™

## SCIENCE-FICTION GAMING SECTION

WHOEVER YOU ARE, YOU'VE JUST  
MADE A BIG MISTAKE.



Super-powered heroes are tough, but how tough can they be and still be playable? This special issue takes the top four hero games and tackles the problem, using the combined might of the four most powerful super-heroines in existence! (And there's a special surprise from Jeff Grubb as well.)

Dark Phoenix™ in action  
Artwork by Terry Austin and John Byrne



# Phoenix Phoenix Phoenix Phoenix

*The outer limits of the  
MARVEL SUPER HEROES™ game*

by Roger E. Moore

Who is the most powerful hero that one can play in the MARVEL SUPER HEROES™ game? One thinks of characters like Thor™, the Hulk™, and Doctor Strange™, yet there are a few who transcend even these beings in sheer power and ability. Are these beings playable in the game? If

so, how can they be managed?

Without question, one of the most powerful heroes in the Marvel Universe™ was the being known as Phoenix™. In her short career, she both saved and nearly destroyed the known universe with her powers. This article focuses on Phoenix (and Dark Phoenix™) in the MARVEL SUPER HEROES game and on ways in which she and others like her may appear.



Phoenix-force would appear around her in the shape of a huge, flaming bird of prey. This flaming bird was composed of cosmic flame, which could cover a variable area from 1-100 areas, depending upon her desires and the amount of power she was using. Though the "bird" was not known to touch anyone, it could do Unearthly flame damage if used as a weapon.

The various aspects of her phoenix-force powers are described below; these scores are for her *maximum possible safe output*, the limits beyond which she cannot go without risk of loss of self-control (and playability).

Note: Any action requiring a Green Psyche FEAT roll to keep from changing into Dark Phoenix (see limitations) also results in the loss of 100 Karma points. Yellow FEAT rolls involve the loss of half of all existing Karma or 100 Karma points, whichever is greater, and Red FEAT rolls are accompanied by the loss of all Karma. No Karma may be added to any Dark Phoenix check.

*Telekinesis:* Phoenix could telekinetically lift weights as if she had Unearthly Strength, affecting objects at Unearthly range in her line of sight. A group of objects in one area was carried as one object.

Using telekinetic control over molecular structures, Phoenix could fire concussive force bolts from her hands with Unearthly

## PHOENIX™

"Jean Grey™" (no real name)  
Unknown energy being

Fighting:	GOOD	(10)
Agility:	GOOD	(10)
Strength:	TYPICAL	(6)
Endurance:	UNEARTHLY	(100)
Reason:	GOOD	(10)
Intuition:	EXCELLENT	(20)
Psyche:	CLASS 1000	(1000)
Health:	126	
Karma:	1030	
Resources:	Class 1000	
Popularity:	50 (Phoenix)	
	-100 (Dark Phoenix)	

## Known powers:

PHOENIX FORCE: Phoenix had access to incredible power on a cosmic scale. In effect, the normal mutant abilities of Jean Grey as Marvel Girl™ — telekinesis and telepathy — were magnified a thousand-fold in the phoenix-being. However, depending on her emotional state, imagination, experience, and mental restraints, Phoenix often functioned at levels far below her maximum capability. Phoenix could use three of her powers at once without effort, and more powers if she made a Yellow FEAT roll for each extra power used.

When Phoenix used her powers, the

power and Class 1000 range, and could produce a personal force field capable of absorbing Class 1000 amounts of any damage (save from mental, psionic, or magical attacks). Because of her control over molecules (similar in many ways to that now used by the Molecule Man™), Phoenix could fire blasts of Unearthly heat or cold as well as telekinetic force bolts. She could also cause objects to freeze or burn spontaneously by mental command if they were within Unearthly range, inflicting up to Unearthly damage each turn.

Phoenix was also capable of telekinetic flight, propelling herself at up to Class 1000 speeds in space. If flying in an atmosphere or carrying passengers with her telekinetic powers, however, she kept her maximum speed at Unearthly levels and protected the passengers with Unearthly-class force fields. Phoenix was able to combine her speed and use of a force field to turn herself into an unstoppable ram, punching through starship hulls with ease.

By altering her own internal molecular structure, Phoenix was able to completely regenerate all of her wounds in one turn. She could ignore the extremes of heat and cold with Class 1000 ability so long as she was conscious, and could withstand arctic cold or the furnace at the heart of a star. She could make herself immune to all corrosive atmospheres and substances, and could exist in any environment.

Her molecular control allowed her to control weather as well, and she could summon or create any form of atmospheric phenomenon (windstorms, tornadoes, lightning, rain, etc.) within Unearthly range, and having up to Unearthly effects.

Use of her telekinetic powers to slay another being brings about an immediate Red Psyche FEAT roll to avoid turning into Dark Phoenix, if the killing was combat-related but entirely accidental. This roll may be reduced to a Yellow FEAT if the slaying was not combat related and was by accident, but the resulting emotional upheaval Phoenix experiences will be strong in any event. Premeditated murder brings an automatic change to Dark Phoenix.

*Atomic transformation:* At first believed to be an advanced form of her telekinesis power, this Unearthly ability allowed Phoenix to transform any one substance into another. She could even transform living substances into nonliving materials (such as turning a tree into gold, or a houseplant into solid crystal), and was able to turn the solid-steel body of Colossus™ back into flesh against his will – and keep it that way. On a mundane level, Phoenix used this power to alter her clothing and costume (and those of everyone within line-of-sight range). Assumedly, Phoenix could create corrosives and poisons – but doing so against a living opponent would cause her to make a Yellow Psyche FEAT roll to keep from changing into Dark

Phoenix, with a Red FEAT roll following if her opponent died (with automatic failure if murder was intended).

If Phoenix uses this atomic transformation power on a living being, she must make a Psyche FEAT roll to prevent reversion to Dark Phoenix. Using it on unintelligent life like plants produces a Green FEAT roll; if used on living creatures (reptiles, mammals, etc.) that are not considered to have human-level intelligence or be capable of developing a civilization, she must make a Yellow FEAT roll. Using this power on an intelligent, thinking being of any sort (which Phoenix would be able to identify at once by telepathy) causes a Red FEAT roll. At the worst, using this power to purposefully kill an intelligent, living being causes automatic reversion to Dark Phoenix form.

*Power absorption:* Phoenix was able to increase her Health by absorbing raw energy in the area around her. She could draw in Class 1000 amounts of power in a single turn, but could take no other action in that turn. However, drawing in power induced a craving for more power and threatened to bring out the Dark Phoenix within her. If absorbing energy of up to Excellent levels, Phoenix must make a Green Psyche FEAT roll or revert to her Dark Phoenix form. If taking in energy up to Amazing levels, a Yellow Psyche FEAT roll is required. Energy absorption of up to Shift X power requires a Red FEAT roll, and absorption of Class 1000 power automatically causes a reversion to Dark Phoenix.

*Telepathy:* Phoenix was capable of reading thoughts at Unearthly distances with Unearthly power. She could fire bolts of Unearthly mental power at the same range, doing Unearthly damage or stunning victims for 10-100 turns. Because her telepathic ability was uncontrolled to a certain extent, she commonly read the thoughts of everyone within three areas of her and suffered no Karma loss for mind-reading.

Phoenix was easily capable of altering the thoughts and personality of an opponent in the manner of Professor X™, though she did so in desperation. She drove Mastermind™ insane, but did so in order to save her personality. An attempt to alter someone's thoughts, personality, or sanity produces a loss of all Karma and a Green Psyche FEAT roll to avoid turning into Dark Phoenix. Phoenix need only make a Psyche FEAT roll to accomplish the above, shifting to the left one column for every rank of Psyche over Typical possessed by her opponent.

*Space-warp creation:* As an outgrowth of her abilities to rearrange matter and energy, Phoenix could create space warps through which she would travel across the universe at hyper-light speeds. This power functions as a sort of teleportation ability at the Class 1000 level, reaching intergalactic distances with ease.

Note: Phoenix could increase any of the above-mentioned Unearthly limits on her powers, but doing so risked bringing on her Dark Phoenix form. A shift X power usage means a Green Psyche FEAT roll to prevent the reversion, while Class 1000 use means a Red FEAT roll.

**Talents:** Fashion modeling (Good ability)

**Personality:** Phoenix duplicated the majority of Jean Grey's behavior and attitudes. She tended to be absorbed in her own problems, but she possessed a strong moral character and desired to do good. She was proud of her "mutant" heritage (still believing herself to be the original Jean Grey) and would go to great lengths to help her fellow X-Men™.

Phoenix had extremely close ties with numerous mutant heroes. Cyclops™ was her lover and was closest to her. Storm and Colossus were like sister and brother to her, and Moira MacTaggart™ thought of Phoenix as her daughter. Wolverine™ bore a secret love for Phoenix, and Professor X was her mentor (and a distant fatherly figure as well). Of course, the events of the Dark Phoenix period and Marvel Girl's reappearance may have altered these conditions.

Because of her past dealings with Sentinels™, Magneto™, the Hellfire Club™, the Shi'ar™, and Mastermind, a reborn Phoenix may harbor considerable dislike for these beings. She would try to handle it appropriately, but may find herself seriously considering a more lasting revenge against them. If she fails a Green Karma FEAT roll upon encountering these beings, she may take steps to ensure that they never have the chance to harm her or her friends again (player's choice as to the handling of this matter, but the Judge should keep Karma losses and chances for Dark Phoenix appearance in mind).

**Limitations:** Phoenix was essentially an energy being who adopted Marvel Girl's human form and personality, but was not able to eliminate or control its original nature. The phoenix-force represents the emotional principle of rebirth through destruction, and this conflicted with Jean Grey's personality, which sought to use reason, create, and do good. So long as "Jean Grey" was in control of Phoenix, she behaved in a responsible and self-sacrificing manner.

However, the Jean Grey persona was continually tempted by the lure of her own powers and rattled by mental assaults from criminal forces, particularly Mastermind, which eroded her self-control. It is possible that Phoenix was driven insane by her own dual nature and conflicting desires to do good and to destroy. Any action that led to the death of another being, the altering of its essential nature or personality, the absorption of high levels of power (feeding her passion and

bringing out her darker side), or the loss of her self-control (if she is mind-controlled by another being, for instance) would push Phoenix toward reversion into Dark Phoenix, her destructive counterpart.

If mentally attacked by another being, Phoenix is considered to have a Psyche of merely Excellent, reflecting her internal conflicts that make her susceptible to mental control. She may make a Red Psyche FEAT roll every 1-10 turns in order to throw off someone else's domination of her free will. If she loses control of herself by another being's actions, she must make a Yellow Psyche FEAT roll upon her recovery or else revert to Dark Phoenix form in 1-10 turns. She can give warning of her loss of mental control to her allies. Any form of immediate comfort offered her will alter the roll to a Green one.

Dark Phoenix is essentially an insane and destructive goddess who will do all in her power to gain even more power, without regard to the effects on anyone else. Dark Phoenix may briefly retain certain moral inhibitions (such as those preventing her from killing heroes who were closest to Phoenix), but otherwise she cares nothing for anyone but herself. The murder of billions of innocents would not even make her blink, and she takes great pleasure in toying with her prospective victims. The green areas of Phoenix's costume turn red when this reversion occurs.

As noted above, certain actions may cause Phoenix to revert to Dark Phoenix form. Once this happens, the Dark Phoenix persona remains in control for 10-100 turns (and is controlled by the Judge). After this, a new Red Psyche FEAT roll may be made; success indicates that the good Jean Grey personality (the player) comes into control. Reversion to Dark Phoenix means an automatic loss of all Karma. Pleas from Jean Grey's closest friends may also bring about a change from Dark Phoenix to Phoenix. Cyclops can induce a Red Psyche FEAT roll to stop Dark Phoenix, because of Jean Grey's love for him and because of their telepathic communion. Storm™, Moira MacTaggart™, Wolverine™, and Colossus each have one chance in 100 (roll 00) of stopping Dark Phoenix with their appeals. Professor X may attempt to draw out the Jean Grey persona by using his telepathic powers, though it will take a Psyche FEAT roll on the Feeble column for him to do so. Few other beings even have a chance to cause a Dark Phoenix-to-Phoenix reversion.

As a final limitation, Phoenix's Karma cannot be pooled with any other being or group. She is a breed apart and cannot share herself fully with others.

**Background:** The story of Phoenix begins with Marvel Girl, who piloted a space shuttle through re-entry in Earth's atmosphere after a space-station battle

between the X-Men and renegade forces of Project Wideawake™. During the re-entry, radiation bombarded the shuttle, and Jean Grey was believed to have died from exposure to it — only to be reborn as Phoenix after the shuttle crashed in Jamaica Bay.

Phoenix claimed that she was in reality Jean Grey and had been restored to life by the power of the phoenix-force, a primal energy being associated with the living force in the universe. In later years it was learned that Jean Grey had actually been approached by the phoenix-force and offered the chance to save her friends aboard the shuttle, in exchange for giving up her identity to the force and letting her own body lie undiscovered at the bottom of the sea while it healed from its radiation-induced injuries. The being known as Phoenix fully believed, to the very end, that it was truly Jean Grey.

Shortly after her "rebirth," Phoenix literally saved the universe from the mad Emperor D'ken in the Shi'ar Galaxy. Using her powers to their fullest, she entered the M'krann Crystal, a device holding a neutron galaxy in check with stasis fields, and single-handedly knit the stasis fields around the galaxy together again, a feat that no living being could imagine happening. Afterwards, she appeared to have burnt out her powers, and possessed Marvel Girl's powers in all respects.

However, Phoenix had merely imposed unconscious limits on her own powers. As time went on, it became apparent that Phoenix's powers were gradually increasing again, with no upper limits in sight. Tests run by Moira MacTaggart indicated that Phoenix would soon operate on god-like levels. Her teammates in the X-Men became concerned over Phoenix's rise, and Jean Grey's lover, Cyclops, was especially disturbed.

The crisis came to a head when Mastermind manipulated Phoenix's mind in order to make her a pawn of the Hellfire Club™. He succeeded in turning Phoenix to evil as the Black Queen, but Phoenix broke free of his control long enough to drive Mastermind insane. Her mental control shot, she suddenly reverted to Dark Phoenix form and attacked her fellow X-Men.

Dark Phoenix defeated the X-Men with ridiculous ease, then gated herself across the universe to the Shi'ar Galaxy, where she caused a sun to go nova to feed her craving for power. The nova incinerated five billion aliens on a neighboring world, and a Shi'ar warship that fired on her was promptly destroyed, too — but not before its captain warned Empress Lilandra™ of Phoenix's appearance. The armed might of the Shi'ar Empire then gave chase.

Dark Phoenix returned to Earth with murder on her mind, but was successfully exorcised of her madness by Cyclops and Professor X. However, the avenging Shi'ar teleported Phoenix and the X-Men aboard one of their starships and revealed the

extent of Dark Phoenix's rampage. To prevent Phoenix's immediate execution, the X-Men fought the Imperial Guard™ in a trial by combat, believing that she should not have to pay for her deeds when she was insane. The X-Men lost, but Phoenix (realizing she couldn't control her destructive urges any longer) activated an ancient war machine by telekinesis and killed herself.

In later years, another heroine named Phoenix appeared from an alternate universe. This Phoenix was the daughter of Jean Grey and Cyclops, but Jean Grey had lost all of her Phoenix powers. This new Phoenix is described in MHSP 2, *Secret Wars™ II*, and she has little of her mother's phoenix-force powers (save for what the Beyonder™ gave her for a time).

### The Phoenix arises again

Though she is believed to be dead at present, it is entirely possible that Phoenix could reappear in the Marvel Universe. The Phoenix of legend was able to arise from its own ashes, and Marvel Girl (or another telepathic/psionic hero) might accidentally summon Phoenix *in extremis*. A Phoenix from an alternate or divergent universe (such as the one who survived the annihilation of her own universe at the hands of Korvac™ and went off looking for a new universe to call home in the WHAT IF?™ series) might find her way to the campaign world.

Should Phoenix reappear, her first task will be to stay alive. All super-hero forces on the planet (and many elsewhere in the universe) regards Phoenix as an evil, insanely destructive entity, and will attack her on sight with all the ferocity that the heroes showed the first Phoenix and later the Beyonder. The Avengers™, the Fantastic Four™, the Shi'ar Imperial Guard, and even criminal groups such as the Hellfire Club (which felt her power once before) would spare no expense and take no quarter in trying to destroy her. In addition, she is regarded as a threat by the Shi'ar, Skrull™, and Kree™ empires, and all three would lay aside their in-fighting in order to hunt Phoenix down and annihilate her. If Phoenix is still having internal conflicts over her good and evil sides, this certainly isn't going to help her.

Of all those who knew Phoenix, only a few might have a chance of overcoming their urge to destroy her. Cyclops and the others mentioned above who were closest to her would be most likely to try to come to terms with her, but this cannot be guaranteed. (After all, the *real* Jean Grey is alive and well now!) Hiding her presence would be hard for Phoenix, who liked showy displays of power. Her power usage could be detected by Spider-Man™'s spider sense, the Silver Surfer™, Doctor Strange, Professor X, complex monitoring equipment maintained by the Fantastic Four



and other organizations, and by Cyclops's telepathic awareness that he gained from close contact with Jean Grey.

### Class 1000 adventures

If her existence could be hidden from the interstellar empires and Earth's heroes at large, Phoenix might find adventure interacting with other equally powerful beings — among them Molecule Man, Odin™, Zeus™, the Celestials™, Death™, Eternity™, the In-Betweener™, Korvac, Mephisto™, the Elders of the Universe™, Ego™, Thanos™, and Galactus™. Note that several of these beings are supposed to be dead — but this, of course, could be altered.

The MARVEL SUPER HEROES game begins to lose its balance as a character's abilities enter the Class 1000 level, but with the proper restrictions even the mightiest characters can be played. In the case of Phoenix, most of her powers are balanced by the danger of turning into Dark Phoenix (and being turned into an NPC run by the Judge). The player who uses Phoenix should be finely aware of the responsibility that comes with endless power; indeed, Phoenix herself was in the habit of applying an upper limit to her power use (assumed here to be on the Unearthly level).

It is conceivable that a group of players may wish to use several Class 1000 heroes on an adventure. Imagine trying to come up with a scenario to challenge Phoenix, Molecule Man, Galactus, and Zeus! It can be done, however (though it will take a little time). Note, for example, that several of the Class 1000 beings above are (or were) villains. Some, like the Celestials, seem to surpass all but the Beyonder in power. A Class 1000 being can be challenged by a fleet of starships, an invasion of Unearthly-class demons from Mephisto, a reanimated suit of Destroyer™ armor, and so forth. Masses of low-level sorts can be as effective as tougher ones (just as a swarm of wasps can be as bad as a single wolf).

Then, too, one must consider the personality of the characters involved. Phoenix is an adventurer at heart, true enough — but Molecule Man wants to be left alone to live with his girlfriend Volcana™, Zeus usually has governmental matters on his mind, and Galactus is basically interested in raiding the stellar ice-box all day to feed his hunger. It might be better to arrange for adventures in which Phoenix is played with an assortment of Unearthly-class heroes, such as Hercules™, Thor, and the rest — but then you run into the old problem of convincing the good guys that Phoenix is a good guy, too. The chances of that happening might be very, very slim. Perhaps the easy-going Molecule Man (who tutored the Beyonder, after all) would help out, and the Silver Surfer would be a good bet to befriend her. Beyond that . . . ?

When designing ultra-tough adventures for Unearthly-class characters (and above), the following points should be kept in mind:

1. Avoid always threatening the existence of the Earth or the universe. Secret Wars II did a nice job of threatening everything there was, and saving the Earth becomes an old theme after a time. But outer space is full of places that could challenge the abilities of any hero or villain. Aliens could come to Earth and request aid to save their people from extinction or conquest. A mammoth starship could enter the solar system on an unknown mission. An alien life-force could have invaded Galactus's world-ship and placed him in suspended animation, and his Herald Nova™ might need help in removing it. Then, there is always the Secret Wars I model (kidnapped heroes fight kidnapped villains in cosmic arena). This can be overdone, of course, though the Grandmaster™, the Collector™, and Kang™ seem to enjoy this.

2. Use a wide assortment of foes. If high-strength heroes fight only other high-strength heroes, the Judge will see yawns from the players before long. Use variety when choosing villains: magic-using foes, mentalist foes, multipowered enemies, etc. If a hero has a weak spot, hit it now and then (though this could prove fatal to everyone in Phoenix's case; use good judgement here).

3. Vary the damage done by attacks. The reason for this becomes obvious when an Unearthly-class attack is pitted against Unearthly armor, or any other such situation. It stands to reason that some damage must get through sometime. One solution to this is to vary damage done by attacks, while keeping armor values constant. One table that varies attack damage within a range of 20% higher or lower appears below. Damage values below Good are too low to bother with; those at Class 1000 level are too high.

Attack power	Base rating	Variable rating
Good	10	2d4 + 5
Excellent	20	2d4 + 15
Remarkable	30	2d6 + 23
Incredible	40	2d8 + 31
Amazing	50	2d10 + 39
Monstrous	75	3d10 + 59
Unearthly	100	2d20 + 79
Shift X	150	3d20 + 119

4. Spell out a powerful character's powers as completely as possible, and allow only one character per player. If the characters powers are specific (as well as its limitations), then the player will have a clearer idea of what sorts of things he or she can try, and the player will have his hands full anyway figuring out what to do next.

5. Use mystery and problem-solving in addition to straightforward punch-'em-out fights. If Phoenix cannot hit a foe with a force-bolt, maybe she could talk him out of his crime — or even apply a gentle, friendly threat that harms no one. Problem-solving adventures, involving careful planning, strategy, and creative thought, are always good ways to keep even Phoenix and Molecule Man busy.

6. Finally, apply limitations to Class 1000 abilities that could threaten game balance. Phoenix, as given above, can reach Class 1000 power in almost any area — but doing so is very risky for her, and she should set her limits lower than that. Applying fixed limits beyond which certain penalties come into play is a good method of controlling the character's actions, and on-the-spot judgements on Karma losses and so forth are also helpful. Any Karma loss should be considerable for powerful characters, particularly since the PCs have a greater responsibility to check their powers. Acting out of character may also cause a substantial Karma loss (100 points minimum). Another limitation for any Class 1000 character is to prohibit the use of Karma pools; otherwise, game balance takes a walk.

### The NPC Phoenix

Much of the above information should be useful in figuring out adventures for an NPC Phoenix controlled by the Judge — which in the long run might be the best way to handle her in most campaigns. Phoenix (even at the somewhat scaled-down levels above) may prove too overwhelming to use, though it could prove to be interesting in the sorts of player-to-player interaction it produces.

Should Phoenix ever turn to Dark Phoenix, the Judge should play her to be as savage, vicious, vindictive, ruthless, and destructive as possible. If you don't want to kill heroes, be sure to scare them! Undoubtedly, this might be a good time to trot out Molecule Man to clean up after her, and a contest of wills between the two would be an interesting problem. Perhaps the players could take the roles of several Class 1000 beings who are trying to hunt down Phoenix and destroy her, if the Judge feels up to it. Otherwise, the players will be concerned with staying out of the way as Phoenix mixes it up with the other Class 1000 types.

Finally, a series of scenarios could be played out in which an NPC Phoenix returns and the heroes have to decide how to handle her. Since she might not initially be in Dark Phoenix form, it would be wise to handle her carefully (as with the Beyonder). In time, she might be convinced to leave for parts unknown, rejoin the phoenix-force, or turn fully human (and become completely normal). The possibilities are endless.

# Maxima

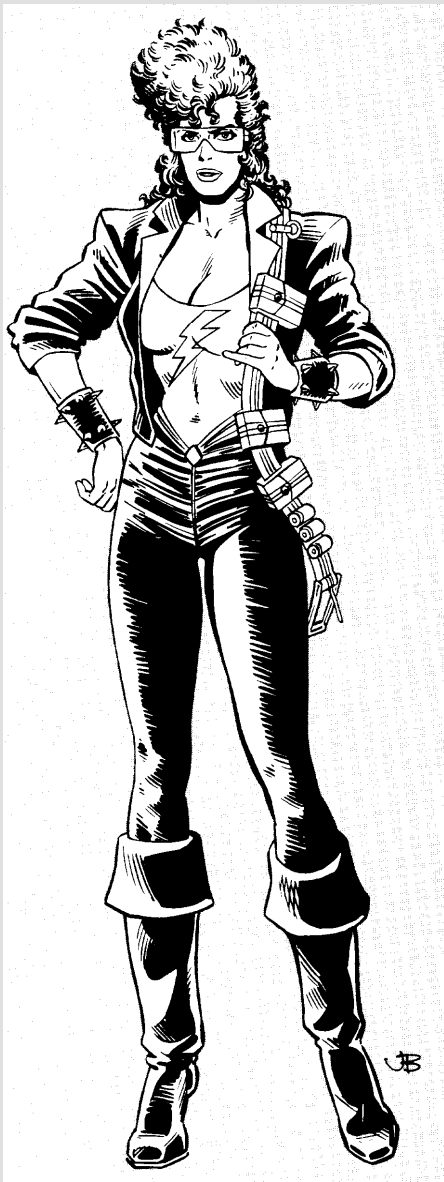

*Back from the future in*  
**VILLAINS & VIGILANTES™**  
*gaming*

©1986 by Jack Herman

VILLAINS & VIGILANTES is a trademark of Fantasy Games Unlimited. Maxima is copyright ©1986 by Jack Herman. All Rights Reserved.

## MAXIMA

**Side:** Good (independent)  
**Experience:** 269,000  
**Age:** Special

**Sex:** Female  
**Level:** 20  
**Training:** Scholar

### Powers:

1. Armor Device: Genetic implant, ADR 130, increases body density with no Agility loss, 100% human in appearance, Strength = 1/hour or turn of Defense), Regeneration
2. Heightened Speed: + 1000" to movement, + 33 to initiative
3. Invulnerability: 30 points
4. Heightened Strength: + 30
5. Heightened Endurance: + 30
6. Heightened Agility: + 30
7. Animal Powers: Strength + 20, Endurance + 20, Agility + 20, Intelligence + 20, Heightened Senses (Detect scores x 3), Natural Weaponry (+ 3 to hit, +6 to damage HTH)
8. Lowered Intelligence: Massive memory loss

**Height:** 7'6"  
**Weight:** 663 lbs.  
**Agility Mod.:** -  
**Endurance:** 86  
**Intelligence:** 40  
**Reactions from**

**Good:** +3  
**Damage Mod.:** +18  
**Accuracy:** +12

**Carrying Cap.:** 384,604  
**Basic HTH Damage:** 7d10  
**Detect Hidden:** 84%  
**Inventing Points:** 80

**Hair:** Blonde  
**Basic Hits:** 14  
**Strength:** 105  
**Agility:** 85  
**Charisma:** 20

**Evil:** -3  
**Hit Points:** 19,374  
**Healing Rate:** 37.8/turn  
(189/turn for armor)

**Power:** 316  
**Movement:** 1276" (290 mph)  
**Detect Danger:** 96%  
**Inventing:** 120%

**Origin and background:** In some uncountable future era, mankind awaited his own extinction, brought about by his own hand. Atomic, bacteriological, and chemical warfare rendered the ground radioactive, the air infectious, and the water toxic. Barely one human in ten million survived the blast of war.

Seven of the last remaining scientists on Earth retreated to a labyrinthine series of tunnels, the remains of an old military base, beneath the deserts of what was once New Mexico. Together, they formed The Covenant; their mission — to save the human race. While two of the team set to work on theories and mechanisms involving the esoteric science of time travel, with the ultimate goal of visiting the infamous "Day the Bubble Burst" and setting things aright, the other scientists (being more pragmatic) devoted themselves to genetic engineering. The latter five hoped to create a special strain of human being who could not only survive but thrive in the ruined Earthly environment.

Despite the pressures of diminishing resources, power, and time, and despite the deterioration of their natural lifespans and health from exposure to radiation, toxins, and bacteria, the desperate scientists produced not one but two miracles. First, they created a one-shot time capsule with a range of a few dozen centuries. Second, they created a perfect specimen of their ultimate human being — an artificially grown female named Maxima. Her skin was stronger than steel, her speed and molecular density drastically increased, and her healing and immunity processes incomprehensibly fast. Maxima's animalistic tracking skills and instincts more than compensated for her lack of formal martial-arts and survival-skill training. Though she appeared to be in her mid-30s, Maxima was a month old when sent on her mission.

The complexities involved in creating Maxima, as well as the lack of time and material, precluded producing any other beings like her. The scientists decided that the human race was doomed unless they could send Maxima, as an agent of The Covenant, back into time to prevent the destruction of the world.

After a hurried, computer-programmed education, in which Maxima was hypnotically implanted with specific instructions on diverting the Apocalypse, the time machine was set for the latter half of the twentieth century. Maxima entered the machine, a button was pushed, and she was gone. . . .

Despite the precautions, a virulent germ played havoc with Maxima's immunity system. When she arrived in New Mexico in 1986, she had a raging fever and was near death. Luckily, she was found and nursed back to health by Neville Taylor, a reporter for the *Weekly World News* who had come to New Mexico to investigate a UFO sighting. Maxima soon recovered, but found to her horror that the fever had erased many of the exact details of her mission from her mind. All she could now recall was that her mission involved the destruction of something called "Prima 1" — whatever *that* was. What few details she could remember of "Prima 1" now seemed ambiguous, conflicting, or obviously false.

Taylor, who fell secretly and hopelessly in love with Maxima, offered his services as her guide through the twentieth-century world around her. She accepted the offer, and ever since then their lives have been one breath-taking, blood-curdling adventure after another.

### Using Maxima (and those like her)

Despite the horrendously heavy stress to what we in super-powered hero gaming circles smirkingly call "game balance," I would be hard pressed to turn down a player who wished to play Maxima in a campaign that I was running. Her background is well developed and interesting, and her origin alone would provide plotlines for dozens of adventures.

I would, however, be careful in designing adventures and combat situations, so as to avoid the two most common pitfalls where characters like this are concerned:

1. Putting the player-character group in situations that Maxima could easily handle all by herself; and,
2. Putting the PC group in situations that only Maxima would be capable of handling.

A good example of the former would be a fight against a group of fairly weak criminals that the PCs don't wish to bother with. Instead, they step back and let Maxima pound the villains. The other extreme would be a fight against several villains, each of which could take Maxima on all by himself. All of the PCs except Maxima are hopelessly outgunned and doomed to defeat.

The solution lies in casting your villains carefully, gauging their strengths against those of your PCs. If every character in the PC group has at least one worthy opponent to face, regardless of the variety in levels or powers, then there will be sufficient suspense generated to make the game interesting for all players.

Maxima herself is hardly invincible. She has much fewer defenses against mental attacks than physical ones, and entrapment or removal from combat using other means is just as effective as a physical defeat. Still, I pity anyone who goes against her hand-to-hand.

With such a fatefully important task as Maxima's, it is quite possible that her mission to save the world might take over the actions of all the players in the group. Having the thrust of a campaign revolve around the goals of just one player character may tend to get boring after a time. Other players may feel cheated or obliged to put aside their own personal goals for their characters. This situation can and should be avoided.

With the open-ended nature of "Prima 1" as it is, the Game Master can make it anything he wants it to be. Some of the PCs' personal arch-enemies may be involved, or the goals of one PC may overlap with those of Maxima for a time. An interweaving of plot-threads that involve each of the PCs helps keep the game interesting for all the players, and it promotes cooperation and camaraderie among them.

And remember — it may be years before any leads on "Prima 1" are found at all. . . .

# DAREDEVILS™

## HAVE ADVENTURES!

You can too! *DAREDEVILS* is a game of role-playing action and intrigue set in the 1930's. Players design and develop their characters who may be investigative reporters, private investigators, globe-trotting soldiers-of-fortune, mysterious cloaked crimefighters, or any of the heroes fostered by the popular culture of the era. The Gamemaster incorporates these characters into fast-paced adventures full of master villains, mysteries, fog shrouded streets, furious gun battles, and cliff-hanger escapes.

So, come and join the adventures.  
Become a Daredevil!

*DAREDEVILS* comes as a boxed set that includes the rulebook, a referee's screen with useful charts and a political map of the world, and *DAREDEVIL ADVENTURES*. This last is a collection of four adventures which allows you to begin play with a minimum of preparation.

The boxed set is available for only \$15.00.

ALSO AVAILABLE:

- *Daredevil Adventures 1: featuring Deadly Coins*
- *Daredevil Adventures 2 with Menace Beneath the Sea*
- *Daredevil Adventures 3: Supernatural Thrillers*

Each adventure is \$5.00

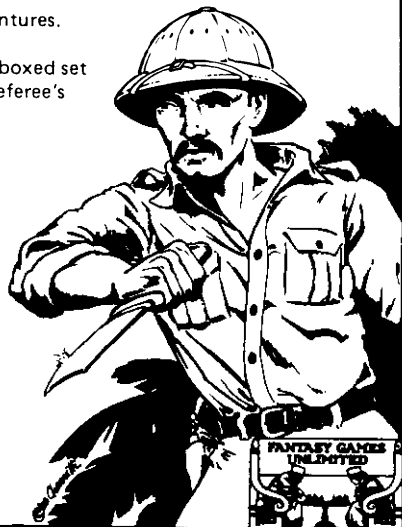

# Lands of Adventure™

A new and exciting Fantasy Role Playing Game with add-on culture packs to adapt the basic rules to various cultures from both history and myth. The basic rules cover everything from character creation and advancement to combat, skills, and magic. Cultures are fully explained for detailed and believable worlds.

The basic game comes as a boxed set including the basic rules, character sheet, and a double culture pack describing the worlds

of Medieval England and Mythic Greece.

Each Culture pack also includes scenario and adventure outlines.

*Lands of Adventure* is a complete adventure role playing game for only \$12.00.

Available from local shops or direct from us: P.O. Box 182, Roslyn, N.Y. 11576

Please add \$2 for postage



New York residents, please add sales tax.



# SUPERGIRL™



## **SUPER GIRL** Kara Zor-el alias Linda Danvers

DEX:	26	STR:	48	BODY:	36
INT:	13	WILL:	19	MIND:	13
INFL:	10	AURA:	8	SPIRIT:	4
INITIATIVE:	49				

### **POWERS:**

Directional Hearing: 10	Super Breath: 20
Extended Hearing: 10	Super Hearing: 10
Flight: 45	Super Speed: 24
Heat Vision: 28	Super Ventriloquism: 15
Invulnerability: 45	Systemic Antidote: 15
Microscopic Vision: 15	Telescopic Vision: 15
Recall: 28	Thermal Vision: 15
Sealed Systems: 20	X-Ray Vision: 20
Solar Sustenance: 50	

### **SKILLS:**

Artist/Actor: 7	Scholar: 10
Charisma/Persuasion: 18	European 1, European 2,
Detective: 7	Literature, Psychology,
Scientist: 10	History

### **EQUIPMENT:**

- Super Uniform (DEX: 0, STR: 0, BODY: 20)  
Uses: 4, Duration: 26, Skin Armor: 10

### **LIMITATIONS:**

Loses all powers under red sun radiation

**VULNERABILITIES:** All of Supergirl's loss Vulnerabilities affect her Attributes, Powers, and Skills.

Green Kryptonite: Rare Fatal and Loss Vulnerabilities, Range 3 APs

Gold Kryptonite: Rare Miscellaneous Loss – permanent loss, Range 3 APs

Red Kryptonite: Rare Miscellaneous – bizarre changes, Range 3 APs

Magic: Miscellaneous – All abilities are reduced to 4 APs against magic (including Mystical Powers or objects).

Miscellaneous Loss – Gravity Attacks subtract their RAPs from all of Supergirl's abilities, but her abilities cannot be reduced below zero from such attacks.

### **CONNECTIONS:**

20th Century  
Chicago (high level)  
Metropolis (high level)  
Midvale (high level)  
San Francisco (low level)  
STAR Labs (high level)  
United Nations (high level)  
White House (high level)  
30th Century  
None

**WEALTH:** Comfortable

### **JOB:**

20th Century	Student
30th Century	Legionnaire

**RACE:** Normal Humanoid

**MOTIVATION:** Upholds Good

### **HERO POINTS:**

20th Century	200
30th Century	150
Crisis period	300

*The Maid of Steel  
in the DC HEROES game*

© 1986 by Greg Gorden



Was Supergirl the most powerful female in the DC Universe? Well, she could cruise to Alpha Centauri in an hour, or circle the world dozens of times a second. She could take a simultaneous hit from every nuclear weapon on planet Earth and fly away unscathed. Supergirl once kicked the Moon out of its orbit; if really pressed, she could have kicked the Moon out of the Solar System. She could live without food, water, or air, and was immune to virtually every man-made toxin. Supergirl could punch through the Empire State Building, battle a hurricane with her Super Breath, and weld together an aircraft carrier from several thousand miles away. As for her mental abilities . . . in about the time you and I would spend reading this paragraph, Supergirl could, at peak efficiency, memorize every single volume in the Library of Congress.

While other DC characters, such as Harbinger in the Crisis On Infinite Earths, have had incredible powers, these powers are only used for a limited number of adventures. The character is then "downgunned." I have found the most consistently powerful female in the DC Universe to have been Supergirl.

### Beginnings

Supergirl's real name was Kara Zor-el, the daughter of Zor-el and Alura, who lived in Argo City. Argo City was the last surviving settlement of Krypton. Kara's parents discovered that Argo City was as doomed as Krypton before it. Following the plan of Zor-el's brother Jor-el, they built a rocketship for the young Kara and sent it into space. Zor-el knew that Jor-el's son had been rocketed to Earth and had grown into Superman. So, Kara's parents put her in a suit resembling Superman's costume in the hopes that Superman would find and care for the girl. Zor-el's planning paid off.

Superman decided to hide the 15-year-old girl, saving her as a

### The 20th Century

After a short period in the Midvale Orphanage, Linda Lee was adopted by Fred and Edna Danvers.

Linda Lee Danvers wore a brunette wig to disguise her blonde hair. Fashioning herself after Superman's Clark Kent, Linda wore glasses. Linda Lee was meeker than Supergirl, but she was rarely had the cowardly reactions which seemed to be Clark Kent's stock in trade. Linda Danvers molded only minimal portions of her Supergirl personality. If adopting a "Linda" attitude differing from Kara's would protect the Supergirl identity, the attitude was adopted. Otherwise, Kara and Linda were quite similar, in contrast to the Batman/Bruce Wayne or Superman/Clark Kent identities.

After proving that she could be both Supergirl and Linda Lee Danvers, Supergirl announced her secret identity to her foster parents. Superman then announced the existence of Supergirl on world-wide television.

Linda Danvers became a student at Midvale High School. Dick Malverne, who had met Linda when the two of them were in the orphanage, was Linda's best friend. The couple had a steady, if not sizzling, romance. Linda also befriended the sister of Lex Luthor, Lena Thorul.

Supergirl moved around quite a bit, changing her base of operations as frequently as she changed costumes. She left Midvale High School before graduating, taking several classes at Stanhope College. She returned to Midvale to take a position as a counselor at the New Athens Experimental College. The Enchantress also happened to have a position at New Athens (see below). The Enchantress was not always a villain. She tried to gain unlimited power and eliminate evil from the Earth, but absorbing such power would have destroyed the physical laws under which the world operated. In order to prevent this, Supergirl kicked the Moon out of its orbit so that the celestial objects would not have their proper alignment. Thwarted in her attempt to become the ultimate hero, the Enchantress turned to evil and became

secret weapon against crime. Doubtlessly influenced by the other "double-L" names of the women in his life, Superman gave Kara the name of Linda Lee. He then placed her in Midvale, a town halfway between Smallville and Metropolis, in the Midvale Orphanage. Supergirl's career began in secret, a heroine unknown to the world.

### In the 30th Century

During this period of secrecy, Supergirl was visited by time travelers, members of the Legion of Superheroes. The Legionnaires offered Supergirl a special membership, one which would allow her to continue her life in the 20th century. Eager to be the hero Superman was, Kara accepted.

Supergirl failed in her first attempt to join the Legion. Red Kryptonite, a rare mineral causing bizarre changes in Kryptonians, changed Supergirl from a girl of 15 into a woman of considerably greater age. The Legion had an age limit of 18, so she had to cool her invulnerable heels in the 20th century until the next test.

At the next session, she and Brainiac 5 were admitted as members. Brainiac 5 and Supergirl began a relationship which continually fluxed between friendship and serious romance. The one constant in their relationship was that it was more important to Brainiac 5 than to Supergirl.

Supergirl eventually resigned from active membership in the Legion of Superheroes. She continued to be available for emergency duty, but her appearances with the Legion became quite infrequent.

Saturn Girl implanted a post-hypnotic command in Supergirl in order to avoid complications arising from Supergirl having knowledge of the 30th century. The command made Supergirl forget the information she had learned of her own future and of the future of Metropolis. She would return from Legion adventures and live a normal life in the 20th century.

Supergirl's arch-foe.

During this time, Fred Danvers became the head of a S.T.A.R. Labs research facility, and Linda had the misfortune to keep falling in love with men who were the secret alter-egos of supervillains. Generally, Kara was the one who broke off these relationships, usually by physically breaking up the bad guy.

Supergirl soon moved to New York to take the choice role of "Margo Hatton" in the hit soap opera, "Secret Hearts." Her acquaintances included Lena Colby (nee Thorul, who had moved to New York from Stanhope), her producer Alan Ward, writer Greg Gilbert, actors Hal Kyle and Cindy Walter, and Jeremy Kane, the show's director. Linda Danver's life in Greenwich Village soon became as convoluted as the scripts from her show. If a relationship could be misunderstood, it was; dark pasts and shady motivations touched everyone. Additionally, Kara discovered New York was positively crawling with heroes and villains. These social complications may have prompted her to make her next move. She wanted to go somewhere where she was unique and a little less harried.

Supergirl returned to Midvale and finally graduated from high school. After a stint in San Francisco and SFTV, she enrolled at Lake Shore University in Chicago. As Chicago's only superhero, she had her hands full with villains who had come to treat the Windy City as their private game reserve. The Council was a constant problem, causing troubles ranging from robot attacks on O'Hare Airport to creating miniature duplicates of Supergirl.

As Linda Danvers, Kara worked for a man who was the operational definition of disorganization: Dr. Metzner. She also became romantically involved with another mysterious man, Phillip Decker, and weathered the return of Dick Malverne. Then came the red rains and the storms of the Crisis On Infinite Earths.

### Crisis On Infinite Earths

To be brief, the Monitor wanted the positive-matter universe to survive, and the Anti-Monitor wished to destroy it. The Monitor



banded together as many heroes from as many worlds as he could before the universe was destroyed to stop his foe. The Anti-Monitor, however, caused the death of the Monitor, and his plan to destroy the universe proceeded more smoothly. Supergirl and fourteen other heroes attacked the stone fortress of the Anti-Monitor, located in the anti-matter universe. The fortress held the machine which would destroy all the positive worlds, as well as the Anti-Monitor himself.

The Anti-Monitor would have killed Superman if Supergirl had not intervened. Supergirl sacrificed herself in battle with the Anti-Monitor. In doing so, she saved Superman, ruined the machines, and destroyed the body of the Anti-Monitor. Her valiant death proved to be the turning point in the war for the fate of the universe. She was only 19 years old.

### Supergirl's Foes

Supergirl seemed to be plagued by myriad one-shot villains. A few foes managed to return several times, and tended to break down into one of four basic types. Examples of each type follow.

**Blackstarr** – Here was a villain who was physically equal, and perhaps superior, to Supergirl. Blackstarr could manipulate the forces which held the universe together, from quarks on up. She attacked Supergirl with “the full force of gravity . . . a thousand billion times more powerful than can be found on Earth. . .” Even that power was not enough to stop Supergirl. Blackstarr was a world-breaker, but so was Supergirl. Supergirl usually could not overpower Blackstarr; she had to trick the villain in order to win.

**Ms. Mesmer** – A member of the Gang, Ms. Mesmer had great mental powers. She could not take on Supergirl alone, as she was physically no match for the Maid of Steel, but her powers could defeat Supergirl’s mental defenses. In concert with another villain, or villains, who could temporarily withstand the assault of

Supergirl, Ms. Mesmer could finish off the heroine.

**Enchantress** – A villain with magical powers, against which Supergirl had only the defenses of an ordinary human being. A fight between the Enchantress and Supergirl resembled a chess match, each trying to bring their special powers into play to close out their conflict.

**The Council** – A technologically oriented villains’ organization, it survived Supergirl’s assaults because the Council was arranged in separate cells. Destroying one cell did not destroy the organization, and secrecy kept the other cells safe. They posed little threat to Supergirl directly, but stopping their plans was difficult.

### Using Supergirl in a campaign

Well, she’s dead, isn’t she? In the DC Universe of the comics, she IS dead – but, in a campaign, this is not necessarily true. Switching the roles of Kara and the Superman of Earth II in Crisis would kill off the older Superman and leave Supergirl alive, and I do not believe the outcome of the Crisis would have been significantly altered. She could also time-travel into the post-Crisis era, though no one will know who she (or Linda Danvers) is!

Currently, the Batman seems to be DC’s choice as the character who forges together new hero groups. I think Supergirl would be a great alternative as the instructor of another group of new heroes. Supergirl and the Batman hold radically different views of good. If the player characters were trained by one hero and an NPC group of heroes was being trained by the other, adventures could be spiced up with the competition between them.

If a player wants to run Supergirl as a character, the GM may have to handle two problems. The first problem is the player who wants to run Supergirl as a supervigilante, totally ignoring her motivations and established personality while gaily incinerating small villages in order to get the one terrorist who is in hiding. A

GM has to enforce motivations, especially for established DC characters. A player may appeal the ruling after the session by showing the GM and the other players a comic in which his character does the sorts of thing the player was trying to have the character do. If the GM is convinced the character would have acted as the player wished, he should give the character an extra miscellaneous award when the adventure is completed. The other players and the GM should examine the circumstances of the action as well as the action itself. Supergirl always went to great lengths avoiding the taking of life. But, when faced with the Anti-Monitor, a being who had murdered untold billions of people, slaughtered Super Heroes, and was about to kill Superman, Supergirl pulled no punches. She was trying to destroy the Anti-Monitor. Unless Supergirl were in a similar situation in an adventure, she would never kill.

The second problem is how to build adventures to handle Supergirl. If one player has Supergirl, the other player characters have to be very powerful or they become irrelevant. With all that power floating around, how do you make adventures challenging? How do you keep a game world intact when you have characters whose biceps produce more energy than all the bombs dropped in World War II?

Part of the solution is to take examples from the comics. In DC comics, the more powerful characters are almost caretakers of the world. They have a responsibility to prevent battle damage from affecting the lives of innocent bystanders. If a head-on collision between a hero and a villain produces a shockwave which starts a tidal wave, the hero had better find a way to stop the wave before it reaches land. If the villains create a diversion which threatens innocent lives, the diversion has to be dealt with before dispatching the villains. Now, powerful villains are even more of a threat, due to the ripple effect of a confrontation.

In the comics, the adventures will sometimes take place in space.

You can let the players vent their spleen in space — assuming there are no inhabited planets nearby. Of course, the villains, freed from the constraint of destroying the ecosystem which keeps them alive, will probably be a tad more vicious as well.

Developing occasional story lines or subplots in which the character's powers are not (or are only marginally) useful is an additional challenge to players. Personal story lines, such as snooty neighbors, romantic interests, or a hostile press are well-tested methods of forcing the character to act as something other than a mobile package of super powers. The only real trick to creating these stories is to make sure that the use of force is ineffective or actually worsens the situation, and that the players do have a chance for a positive outcome if they try other approaches. Give them a chance and a reason to use non-combat powers and skills. Reward them for being characters rather than megapowered fists.

An example of such a situation might be eliminating famine in a developing nation. Problems might include political upheaval, villainous opposition (they may prefer to use the impoverished nation as a terrorist breeding ground), and altering the agricultural infrastructure so the nation's farmers could feed the whole country. Perhaps even the climate must be altered; now, there's a tough job even for Supergirl. If this project were run as a continuing sideshow to the more traditional adventures, the players' characters would become involved with the welfare of the people they are protecting. And, after a few sessions of effort have gone into building up the country, you can bet they will take a personal interest in some villain's threat to destroy their handiwork.

When running really powerful characters, think big. Think big in terms of the villains, and think big in the sort of constructive tasks such powerful heroes may be able to perform. The job is no easy, but you are building adventures for the most powerful of the heroes. Running characters as powerful as Supergirl requires the full power of a Game Master's abilities.

**THE ORIGINAL  
BRUCE LEE  
MARTIAL ARTS  
GAME**



**THE LEGEND LIVES  
LIMITED COLLECTOR'S  
EDITION**

## NIGHT of the NINJA

Can you think like a Ninja?  
Do you expect the unexpected?  
Role-playing that's quick & easy!  
Tasks that are real & deadly!

N  
E  
W

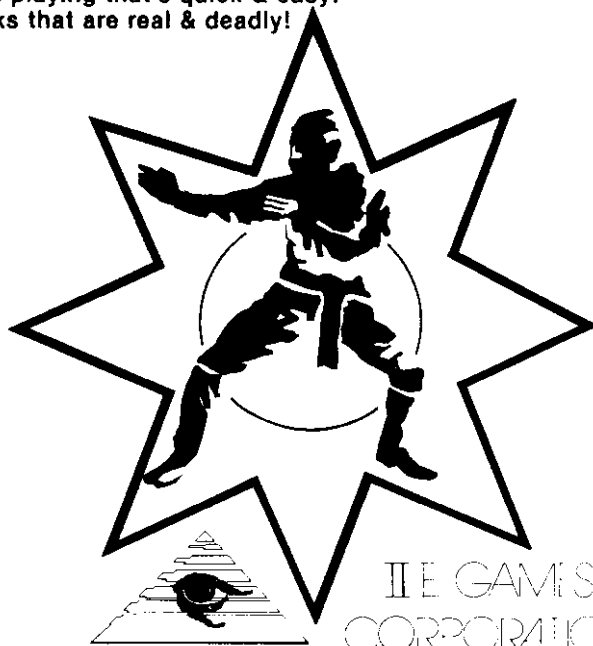

THE GAMES  
CORPORATION

962 James Street, Penticton, B.C., Canada V2A 4A7

"Marketing Tomorrow's Products Today"  
(604) 493-5420

# The Marvel<sup>®</sup>-Phile

by Jeff Grubb

All Marvel character and the distinctive likenesses thereof are trademarks of the Marvel Comics Group. MARVEL SUPER HEROES and MARVEL SUPER VILLAINS are trademarks of the Marvel comics Group. Copyright ©1986 Marvel Comics Group, a division of Cadence Industries Corporation. All Rights Reserved.

*Jeff Grubb had a marvelously written introduction to this article, all of which was cut so this would fit in an issue already crammed with super-powered heroes. He introduced the basic mechanics of the MARVEL SUPER HEROES™ Advanced Set, which should be in your stores about now, and announced that the Marvel®-Phile will be presented in Advanced Set format from this day forward. Sorry, Jeff. At least the long shot came in. — Editor.*

## LONGSHOT™

Real name unrevealed

F	RM	30	Health: 90
A	RM	30	
S	GD	10	Karma: 66
E	EX	20	
R	TY	6	Resources: Fe (2)
I	EX	20	
P	RM	30	Popularity: 0

## KNOWN POWERS:

**Probability Manipulation:** Longshot has the ability to unconsciously manipulate probability fields. Any percentile roll made by a player running Longshot is read with the "high" number as the "tens," regardless of which die is thrown first. If a 1 and a 9 are rolled, the result is 91, not 19. An 11 or any other doubles remain as rolled. Each time the hero rolls a "0" (zero) on one of the two die, the judge rolls a single 10-sided die secretly. That d10 roll indicates which upcoming die roll will be inverted (a stroke of "bad luck," meaning a roll of 9 and 1 would be a 19) for Longshot or his allies. If the player rolled a "0" and a "2", the Judge would roll a die in private, say, getting a "3." Thus, the third roll after that particular FEAT will have reversed numbers, indicating a stroke of bad luck. No further checks for bad luck should be made until the first bad luck occurrence is resolved, so bad die rolls are not cumulative. The Judge should not inform the player that the particular roll is for "good" luck or "bad" until after the decision to spend Karma to alter the die roll is made.

This sudden occurrence of bad luck applies to Longshot's allies as well as Longshot himself. Longshot's opponents never suffer from this good luck/bad luck power. There is no power rank for this power.

**Aura Reading:** Longshot may read the psychic aura of an object with Incredible

ability, such that he may understand the thoughts of those that have handled or will (in the future) handle the object. The auras of those with the strongest emotions (fear, anger, etc.) will be read best. In game terms, Longshot is able to discern the thoughts of some who will handle the object only if the Judge has defined plans for the object in the future; otherwise, he reads auras in the past, and only reads the thoughts the character had while holding the object. Failure of a power rank FEAT will indicate no auras are discernable, the image is blurred from multiple images of equal intensity, or some outside force prevents the reading. Only one attempt may be made per object.

**TALENTS:** Longshot is a stuntman in his own world, and as such has Acrobatics and Tumbling skills. He has Martial Arts A and E, and is skilled in the tossing of cleaverlike blades that inflict Good damage (+ 1 CS to agility FEATs to hit). He is also skilled in the use of jetpacks (allow Flight at Excellent air speeds (six areas/round), Agility FEATs to steer).

**CONTACTS:** Longshot's experiences on Earth have been limited, but he has been befriended by Doctor Strange® and a stuntwoman named Ricochet Rita™. In his own dimension, he is the leader of a rebel organization with Excellent resources.

**BACKGROUND:** The being called Longshot was created in another dimension as a slave for a race known as the Spineless Ones™. Longshot was endowed with super-human abilities, and used them to lead a rebellion against the his masters. The rebellion was crushed and Longshot was given amnesia. He fled from his captors, stumbling into a interdimensional portal and ending up on our Earth. Given the name Longshot as a result of his manipulation of probability to make unlikely attempts come true, Longshot battled his pursuers, his owner Mojo™, and Spider-Man® and She-Hulk®, who thought him a criminal. With the aid of Doctor Strange, Ricochet Rita, and Quark™, another former slave, Longshot defeated Mojo and forced the Spineless One back into his own dimension. Longshot followed him to lead a new uprising among the people enslaved by the Spineless Ones.

While Longshot appears humanoid, he is a genetic construct modeled after "demons" in the Spineless One's mythology. He has only three fingers and a thumb on each hand.

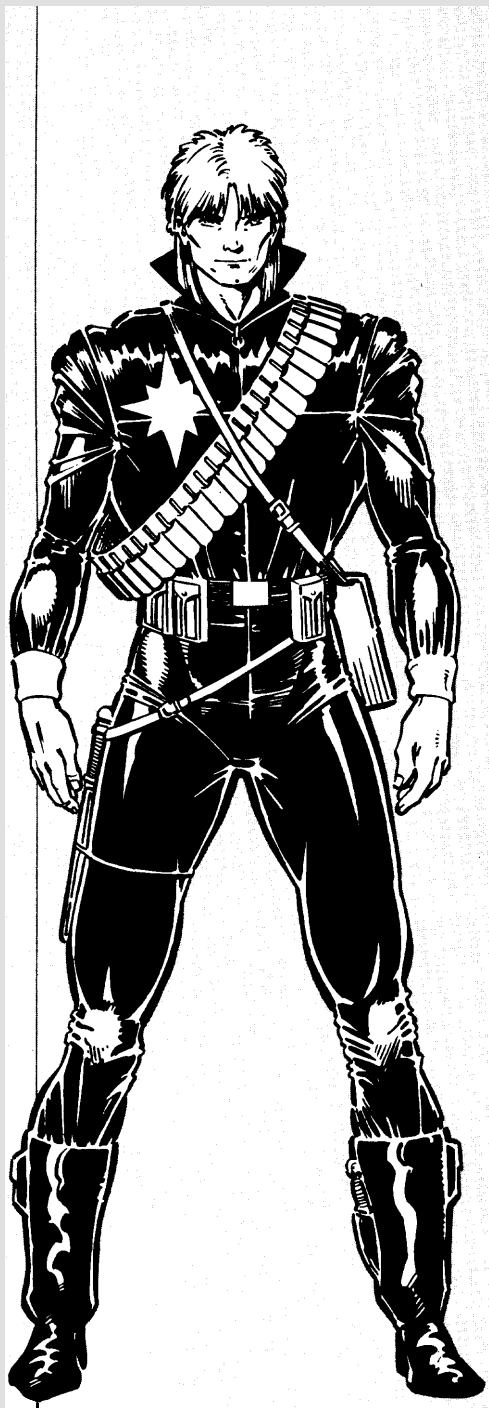

*O, Lucky Man!*



# THE HERO SYSTEM WILL KNOCK YOUR BLOCK OFF!

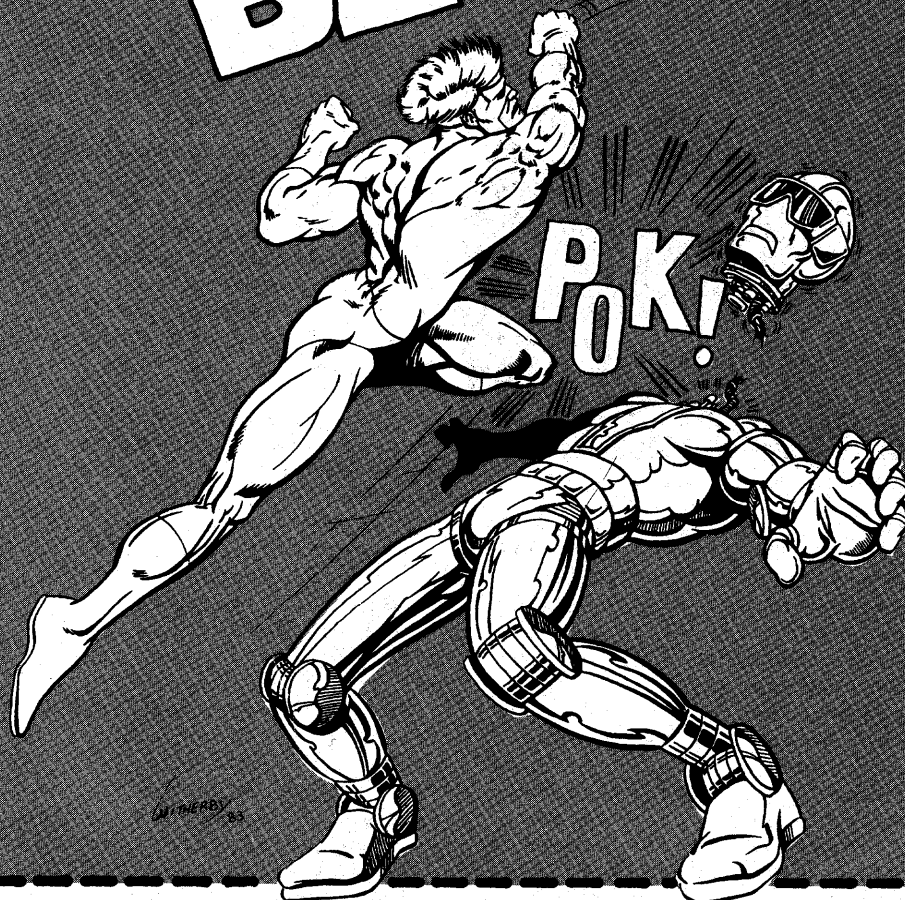

*Champions*, the super role-playing game, is a knockout! The *Hero System* is more than *Champions* though — it's an interlocking system of games, adventures, sourcebooks and player aids. Together they form an action-packed playing environment. Two-fisted *Justice, Inc.* adventurers can battle evil side by side with *Champions* superheroes in the modern world of *Danger International* or in the mythical realms of *Fantasy Hero*. The compatibility doesn't stop there! *Hero System* adventures include game statistics for *Call of Cthulhu*, *Middle-earth Role Playing*, *Daredevils*, *Mercenaries*, *Spies and Private Eyes* and other popular systems. So get a head start — order now and play the *Hero System*.

**PLEASE RUSH ME:**

- CHAMPIONS** (all the rules you need to be a hero) ..... (US) \$12<sup>00</sup>
- FANTASY HERO** (complete guidelines for your fantasy universe) ..... (US) \$15<sup>00</sup>
- JUSTICE, INC.** (relive the pulps & serials) ..... (US) \$10<sup>00</sup>
- DANGER INT.** (rules for high-tech modern adventure) ..... (US) \$15<sup>00</sup>

For each order add (US) \$1<sup>25</sup> postage & handling, Canadians add (US) \$2<sup>50</sup>.  
Send check or money order, no cash or COD. VISA & MASTERCARD orders call (800) 325-0479. VA residents, Canadians & overseas customers call (804) 295-3917.  
1986 HERO GAMES.

NAME \_\_\_\_\_

ADDRESS \_\_\_\_\_

CITY \_\_\_\_\_

STATE, ZIP \_\_\_\_\_

SEND TO:  
HERO GAMES  
c/o IRON CROWN ENT.  
P.O. BOX 1605

CHARLOTTESVILLE, VA 22902

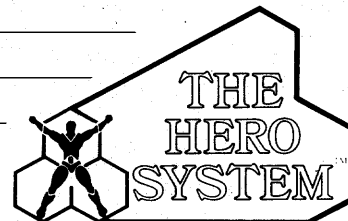

# Quantum



## Power and Super-Power in the CHAMPIONS™ game

CHAMPIONS is a trademark of Hero Games. Quantum is copyright © 1986 by George Mac Donald. All Rights Reserved.

©1986 by George Mac Donald

All heroes want to be powerful so that they can be effective in their own campaign. But when is a hero too powerful in relation to the campaign in which he plays, and how does the Game Master deal with such a hero? This article discusses what makes a hero powerful, offers some ideas on how to use powerful heroes in a scenario, and presents Quantum, a heroine whose power ranges from mild to overwhelming.

### What's powerful?

Super-powered hero games are called "power games," because the heroes can do things far beyond the abilities of normal men. But every player's hero can do things normal people can't do. The measure of power lies not just in what your hero can do; it's what your hero can do better than everybody else's hero.

For the purposes of our discussion, the average power level of a CHAMPIONS™ campaign is based on a hero who can do 10-14D6 Attacks, has Defenses of 20 to 30,

an OCV of 8 to 11, a DCV of 7 to 10, a Dexterity of 20 to 30, and a Speed of 4 to 6. Your campaign may have different power levels, but it is important to know what your campaign's power levels are so that you can judge how powerful a hero is in your particular game.

A general rule is that a hero who exceeds the campaign's power level by 20 power points in any one category will be considered very powerful in that category. Thus, a hero with an extra + 4D6 Attack, + 10 Defenses (there are two defenses), +4 OCV, +4 DCV, + 6 DEX, or +2 Speed over everyone else has a powerful advantage. A hero who combined all of these advantages with no obvious limitations would be more powerful than two or three ordinary heroes.

There are other, more subtle ways a hero can be powerful. A hero may have all of the special defenses like Power Defense and Hardened Defenses, making that hero is less affected by attacks that could overwhelm an otherwise powerful hero. A hero could have lots of Body and Stun

Points and a high Recovery, so that he could weather many more attacks than his defenses might suggest. A hero could also use Special Attacks like Power Drains and NNDs to defeat opponents who have large regular defenses, but are too "narrow" to have Special Defenses.

The least obvious way to be a powerful hero is to be very flexible. Different opponents have different strengths and weaknesses. If your character has fast movement and a variety of attacks, then he can avoid his enemy's strengths and exploit their weaknesses.

### Dealing with power

Given the above, what should the Game Master do when presented with a hero who is exceptionally tough? Such a hero can come from several sources. A new player may bring a hero from a higher-powered campaign. A hero with lots of experience points may play in a game with a group of beginning heroes. Or, the Game Master may let one hero be very powerful in one respect by applying additional restrictions on the hero, perhaps to promote diversity in the campaign.

There are many things a Game Master *shouldn't* do when he allows a powerful hero in his campaign. He shouldn't let the hero be so powerful that he obviates the need for the other heroes. The powerful hero can be given a narrow specialty or a crippling weakness, so the other heroes can all have their turn to shine.

Also ensure that the powerful hero doesn't dominate the game and take up too much of the Game Master's time. The Game Master should center storylines and subplots around all of the different heroes in his group, and resist the temptation to make the powerful hero the center of all attention.

Finally, the Game Master must make sure the powerful hero doesn't gain control of the storyline. The Game Master must make sure the challenges and problems that are the basis of the storyline cannot be wiped away by an unusual wrinkle in that hero's abilities.

There are also several things a Game Master *should* do when he runs a game with a very powerful hero. Most of these are things a Game Master should consider whenever he runs a scenario, but they are especially important when there is a power imbalance in the game.

The first thing to remember is to provide a hero with challenges commensurate with his abilities. If a very powerful hero has a high Strength, you should make sure the tasks he has to deal with are right at the limits of his abilities. If a hero has very fast Flight, make him chase a missile that is just as fast as he is. These challenges make the hero flex his abilities and make it obvious that this hero is "the only one who can do the job!"

The other option is to provide the hero

**QUANTUM**  
**Wendy Lee**

**Quantum power level**

1	2	3	4	5	Characteristics
25	35	45	55	65	STR
23	28	33	38	43	DEX
23	33	43	53	63	CON
10	15	20	25	30	BODY
15	20	25	30	35	INT
10	15	20	25	30	EGO
10	20	30	40	50	PRE
12	18	24	30	36	COM
10	15	20	25	30	PD
10	15	20	25	30	ED
4	6	8	10	12	SPD
10	15	20	25	30	REC
50	100	150	200	250	END
50	100	150	200	250	STUN
8	9	11	13	14	Base CV



**Powers and skills**

1	2	3	4	5	<b>Powers</b>
+10	+15	+20	+25	+30	PD and ED Force Field at ½END Cost (2 END)
—	10	20	30	40	Power Defense
—	10	20	30	40	Ego Defense
—	5	10	15	20	Flash Defense
—	5	10	15	20	Lack of Weakness
7"	17"	27"	37"	47"	Flight at ½END Cost (0 END)
+1	+2	+3	+4	+5	Levels with Photonic Ultra
—	+1	+2	+3	+4	Overall Levels
X	X	X	X	X	Ultraviolet Vision
+2	+3	+3	+3	+3	Enhanced Vision
—	—	X	X	X	Infrared Vision
—	—	X	X	X	Instant change to any clothes
—	—	—	X	X	Regeneration: 2 BODY per Recovery
—	—	—	X	X	Danger Sense, 11 or less
—	—	—	—	X	Faster-than-light Travel
—	—	—	—	X	Life Support (underwater, outer space, and vs. all gasses)
<b>Photonic Ultra (all at ¼END Cost)</b>					
10	14	18	22	26	D6 Energy Attack (2 END)
3+1	4½	6	7+1	8½	D6 Ranged Killing Attack (2 END)
6½	9+1	12	14½	17+1	D6 Endurance Drain at Range (2 END)
5	7	9	11	13	D6 Flash (Radius = # of D6) (2 END)
5	7	9	11	13	D6 Entangle (Defense = # of D6) (2 END)
10	14	18	22	26	PD and ED Force Wall (Length = Defense) (2 END)
—	70	90	130	130	Strength Telekinesis (3 END)
—	14	14	14	14	Body Desolidification (3 END)
—	X	X	X	X	Invisibility to visible light, IR, UV, X-ray, N-ray, and radar with no Fringe (3 END)

The Game Master should decide at which level Quantum is currently operating, and then may look down that column to find the magnitude of her powers and characteristics. If a column has an "X," then that power is available at the basic level and does not increase as Quantum becomes more powerful. Each Quantum level increases the Endurance Cost of each power by one point. At level 1, Quantum costs 300 Power Points, and each additional Quantum level is worth 300 more Power Points. Quantum's Total Cost is calculated as follows:

Quantum level	Cost
1 (basic)	300
2 (at +1 Limit .)	+150
3 (at +2 Limit .)	+100
4 (at +4 Limit.)	+60
5 (at +8 Limit.)	+33

Total Power Point Cost 643

**100 + Disadvantages**

15	DNPC: Doris Jones (roommate, programmer, detective). Normal, 11 or less
20	DNPC: Sam Lui (lover and reporter for the Daily News). Normal, 14 or less
35	Hunted by Doctor Destroyer and minions, 11 or less
35	Hunted by VIPER, 11 or less
20	Psychological Limitation: Easily angered, tends to jump to conclusions and go off half cocked
20	Psychological Limitation: Guilty, always believes things that go wrong are her fault
15	Secret Identity: Wendy Lee (known to a large number of heroes)
15	Susceptibility: 3D6 while at Quantum level 2 or higher and cut off from all light (including visible light, IR, and UV)
15	Unluck: 3D6
20	Vulnerability: x2 STUN and BODY from Darkness-based attacks
333	Experience
643	Total Power Points

with challenges in which his powers make no difference. A hero forced to make a judgement call, like surely saving one bystander or only possibly saving two bystanders, has the same moral decision regardless of his powers. A hero who must convince an alien that he is friendly must use his speaking abilities much more than his combat abilities. Such challenges bring all heroes to the same "human" level.

In combat, the Game Master must be particularly careful when matching villains to heroes. One way to balance combat is to make one villain obviously more powerful than any of the others. Power

tends to draw power, and the two powerhouses will usually fight it out together. The Game Master can insure this by having the most powerful villain purposefully seek out the powerful hero and challenge him.

Another way to utilize a hero who is powerful in combat is to match a particular enemy's powers to the hero's powers. Thus, you might send a hero with a strong attack against a villain with very strong defenses, so that the characters' specialties cancel each other out.

The Game Master can pit characters of dissimilar power together when he wants

to make sure a hero wins or loses a battle. This may be done to move a storyline along or to make a specific point to the hero. Sending a powerful hero against a group of enemies who can do little to stop him is a great ego builder. Sending the same hero against foes who are less powerful but who have abilities targeted against the hero's weaknesses can teach any hero a hard lesson.

The following is an example of a very powerful hero: Quantum, a heroine with over 300 experience points. She is built to be usable in any campaign, because her power levels range from mild to over-





whelming. Quantum's power is fully determined by the Game Master, while giving the player a chance to do extraordinary things!

**Physical description:** Wendy is a 5'9" tall, 130-pound Oriental female. She has long, straight, black hair and green eyes. When functioning as Quantum, she wears a shiny gold-and-red body suit that includes gold boots and red mask and gloves.

**Personality:** Wendy is quick to anger, but also quick to forgive all but herself. She is an idealist, easily offering a comment, a laugh, or a suggestion on any subject. Wendy often accepts blame when things go wrong, even when she was not at fault. Because of this, she carries a lot of guilt about her past mistakes.

**Origin:** Quantum's history crosses those of many villainous forces, including Doctor Destroyer (CHAMPIONS Adventure #1, *The Island of Dr. Destroyer*), Mechanon (CHAMPIONS game book, page 79), and VIPER (VIPER's Nest adventure for boxed CHAMPIONS set).

Doctor Destroyer had assembled the resources of VIPER and Mechanon, along with his own mad genius, to create the awesome Dimensional Interface Generator at a secret base in the Rockies. When

activated to overload status, the generator would flood Doctor Destroyer's armor with power and make him virtually invincible.

The energy waves emitted while the generator was warming up alerted dozens of heroes and super groups that a dastardly plan was afoot, and they made an immediate assault on the VIPER base. The base was guarded by battalions of VIPER agents and dozens of Mechanon's Killbots; soon, a pitched battle raged as the heroes raced against time to penetrate the base and stop Doctor Destroyer before the generator reached overload. But the final defense was a group of hostages, taken from a hijacked plane, ringing the energizing chamber of the Dimensional Interface Generator. Sure that no hero would risk the life of an innocent, even to stop a villain from gaining ultimate power, Doctor Destroyer planned for victory.

Wendy Lee, a second-generation Chinese American, was one of the hostages. She had previously heard the mad Doctor gloat over his plans and sarcastically thank the hostages for their help. Wendy struggled to escape throughout her captivity, but as the Doctor's plan came to its conclusion, she was still shackled to the generator.

As the Dimensional Interface Generator reached overload status, a squad of heroes blasted through the floor and into the generator room. Over the whine of the generator, Doctor Destroyer boomed, "Disturb this generator and all of the hostages die a horrible death!" The heroes, caught in a dilemma, hesitated.

But the heroes' entrance had damaged the energy shackles holding Wendy Lee. She struggled free, grabbed a large wrench which had been left in the hurry to complete the generator, and rushed at the vulnerable energy channels that were hidden from the befuddled heroes. Willing to sacrifice herself to stop the mad Doctor Destroyer, Wendy struck. The Dimensional Interface Generator burst with its overload pulse, enveloping both Doctor Destroyer and Wendy in blinding power.

Doctor Destroyer received some of the energy, and his powers were temporarily supercharged. But Wendy took the brunt of the blast — the blast which destroyed the Dimensional Interface Generator, forever tied Wendy to the vagaries of the unseen Dimensional Interface, and gave her the powers of Quantum.

Wendy then battled the supercharged Doctor Destroyer to a standstill, while the other heroes saved the hostages. Seeing reinforcements arriving, and realizing that his supercharging was temporary, Doctor Destroyer used the last of his power to escape, declaring that he would have his revenge on the heroine who had thwarted him.

After the battle, Wendy's powers decreased tremendously but did not disappear. Some heroes who had witnessed the

battle figured that Wendy's extra power, like the Doctor's, was gone forever. Confused but enthusiastic, Wendy went to New York with some of the heroes to sort out her abilities and her life. There, testing her new-found powers again and again, she found the results were often wildly different. It became obvious that Wendy's powers fluctuated among several discrete power levels, each level many times more powerful than the one before. The fluctuations were seemingly random; sometimes Wendy's emotional state seemed to have an effect on her powers, and other times not.

After careful consideration, Wendy decided to use her powers as a costumed hero. She borrowed her fighting name from a principle of atomic physics, in which electrons jump from one quantum energy level to another, each jump producing photons, or particles of light. Because of her variable energy levels and light-based powers, Wendy called herself Quantum.

Quantum has had a long history of crimefighting in and around New York City. Her career has been a varied one, with fantastic victories over seemingly impossible odds to inexplicable losses against inferior foes. Some high points in Quantum's life include the Skullfleet invasion, in which she held an entire invading armada of starships in its warp gate while other heroes successfully destroyed the warp generator, and the attack of the Supervillain Army, in which she destroyed Mechanon XII in a climactic one-on-one battle.

Quantum has joined super-teams twice, but has voluntarily left each time, believing her teammates could never depend on her fluctuating powers. She is still willing to work with other heroes on a case-by-case basis. Quantum is basically gregarious, but won't make a long-term commitment to any group.

**Current status:** Wendy Lee now keeps an apartment in Manhattan. She lives with her roommate, Doris Jones, a computer programmer and amateur detective, who still doesn't know of Wendy's double identity. Doris is a confirmed snoop and often finds herself in the middle of important cases by accident.

Wendy uses the income from Quantum's toy, book, and poster licensing to support her modest lifestyle. Wendy's cover for her income is that she is the beneficiary of a trust fund from a rich uncle. A helper by nature, she spends her days doing volunteer work for the Asgard Foster Children's Center and the Storefront Legal Defense Group in Hell's Kitchen. No matter how much she does for the community, as either Wendy Lee or as Quantum, she still doesn't feel she's doing enough.

When Wendy isn't doing volunteer work or patrolling as Quantum, she spends time with her boyfriend Sam Lui, a reporter for



the New York Daily News. Sam is a man driven by his search for the truth and has almost uncovered Wendy's secret several times — but he has learned that his inquiries make Wendy very angry, and he is afraid of losing her. Finally, he has decided that, for now, his love is greater than his curiosity.

## Playing Quantum

Quantum is built in as simple a manner as her unusual power structure allows. The base (or Level 1) character is a somewhat inefficient, flying, energy projector, with the minimum power level to fit into any campaign. Each additional level adds a constant amount to almost all of Quantum's characteristics and powers. The Game Master has total control over when the character playing Quantum moves up or down in power level.

Quantum's powers reflect her control over light. She can fly and project a force field, and has a wide range of attacks, drains, force walls, and entangles in her Photonic Ultra. Her characteristics are normal for a character of her type, though her Strength and Stun Pips are somewhat higher than normal. The level 1 Quantum is worth 300 power points.

Each additional level gives Quantum + 20 points in attacks, + 10 to each of her defenses, + 10" flight, and +2 levels. She also gets significant increases in her characteristics, including + 10 STR and CON, + 5 DEX, + 2 SPD, and + 50 END and STUN. Each level is worth 300 power points. Each level costs less however, because they come into play less and less often. Quantum's total cost is 643 power points.

If the Game Master feels an advance in power level is justified by circumstances, then Quantum may attempt an EGO Roll, minus her current power level, at the end of every turn. A successful roll means she moves to the next higher power level.

Conversely, Quantum may move to lower power levels if her emotional state changes, or if she is startled or otherwise confused. She must then make an EGO Roll, minus her current power level, to remain at her current level. Often, near the end of a fight in which Quantum has convinced herself she is victorious, her Unluck will cause her to return to level 1, thus giving the enemy a second chance.

Level 1 is Quantum's normal state, and she has these powers even in her secret ID. Often, after using very high power levels or getting one or more 1's on her Unluck Roll, Quantum collapses back to level 1. At this power level, she is useful as support for heroes going into a battle in which they are otherwise outnumbered or, because she is then easily defeated and captured, as bait in a trap for other heroes.

Level 2 is Quantum's normal fighting

level. It takes very little emotional stress for her to advance to this level, so she will get to level 2 in most runs. At level 2, Quantum is an even match for most characters at the campaign level. She also has increased flexibility because of three additional powers in her Photonic Ultra. Quantum is useful here as support when heroes are going against high-powered opposition, or as a foil for a single hero that Quantum thinks has done wrong.

Level 3 is a highly charged state that allows Quantum to dominate most battles. She only advances to level 3 when very hurt or angry, about one run in three. Her main power additions are simply having more powerful attacks and defenses than others at the campaign level, along with several enhanced senses. At level 3, Quantum is useful for taking on several villains or, if controlled by a villain, taking on several heroes.

Level 4 is seldom reached in normal play; only very special combinations of emotion, circumstance, and dimensional alignment, say one run in ten, allow Quantum to have powers of this magnitude. At this level, she gains some additional internal bodily control with her powers, but has exceeded the point at which characters in a normal campaign level are much of a threat. Quantum is useful here to

throw at an otherwise unbeatable foe, or to hold off a large number of villains while the other heroes accomplish some lesser (but critical) task.

Level 5 is the current upper limit of Quantum's abilities. This is the "goddess level" on which she gains the ability to fly faster than light and exist in outer space. Only the most drastic circumstances should create this power level, about one run in thirty. Here Quantum is useful for holding off alien invasions, stopping natural disasters, and facing cosmic foes. She is useless for normal combat because she hits everything she aims at, can knock most characters out in one shot, and is invulnerable to almost all counterattacks.

The Game Master can use Quantum however he wishes. If he has a special story requirement for a powerful character, but doesn't want to deal with high power levels all of the time, he can let someone play Quantum. If the Game Master wants to balance two sides in combat, or change the balance of a combat suddenly, he can use Quantum himself. Finally, Quantum makes a perfect mind-controlled pawn of a super-powered villain, because she can be as powerful as the Game Master wishes at any time. What you actually do with Quantum in your campaign, of course, is up to you.

ACCEPT NO IMITATION

# VILLAINS AND VIGILANTES™

A SUPER-HERO ROLE-PLAYING GAME

You can combat the forces of evil! You can become a champion of truth and an idol of millions! You can be a superhero and defend the human race against injustice and villainy! You can do all this as a character in VILLAINS AND VIGILANTES.

The rules deal with Superpowers, Combat, Secret Identities, Encounters, Character Creation and more! VILLAINS AND VIGILANTES comes as a boxed set with the rulebook, introductory adventure, character sheet, reference screen and dice for only \$12.00.

**Rulebook Alone . . . . . \$6.00**  
**Introductory Adventure (Crisis at Crusader Citadel) . . \$5.00**

**Additional Adventures Available:** ● Death Duel with the Destroyers (\$5) ● Island of Doctor Apocalypse (\$5) ● Opponents Unlimited (\$5) ● F.O.R.C.E. (\$5) ● Assassin (\$6) ● Most Wanted, Vol. 1 (\$5) ● Most Wanted, Vol. 3 (\$6) ● Dawn of DNA (\$5) ● From the Depths of Space (\$5) ● Battle Above the Earth (\$5) ● To Tackle the T.O.T.E.M. (\$5) ● Devil's Domain (\$5) ● Pentacle Plot (\$5) ● Terror by Night (\$5) ● Organized Crimes (\$5) ● Pre-Empive Strike (\$5) ● DNAgents Sourcebook is coming soon!

**SHATTERMAN:** An American military veteran and rock musician who uses his powers to continue to protect his country from the forces of crime and evil in general.

Identity: Jack Dunn Age: 23  
Side: Good Level: 1

**Powers:**

1. Heightened Endurance: + 19
2. Regeneration: Max. once per turn, takes one action, heals full healing rate.
3. Invulnerability/20
4. Flight: Max. airspeed = 279 mph, PR = 1/hr.
5. Power-Blast: 20 inch range, PR = 1 per shot, does 1d20 damage.

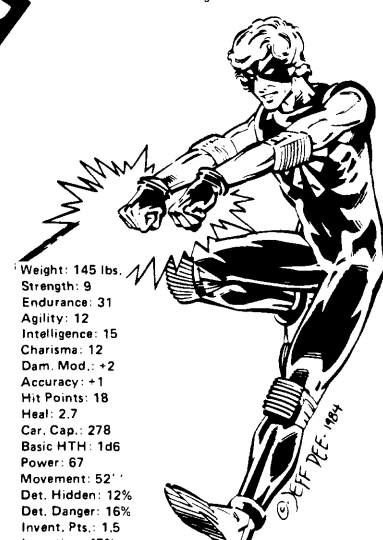

Weight: 145 lbs.  
Strength: 9  
Endurance: 31  
Agility: 12  
Intelligence: 15  
Charisma: 12  
Dam. Mod.: +2  
Accuracy: +1  
Hit Points: 18  
Heal: 2.7  
Car. Cap.: 278  
Basic HTH: 1d6  
Power: 67  
Movement: 52'  
Det. Hidden: 12%  
Det. Danger: 16%  
Invent. Pts.: 1.5  
Inventing: 45%

Available from better shops worldwide or direct from us at:  
P.O.Box 182, Roslyn, N.Y. 11576 (USA).

Please add \$2 for post and handling. N.Y. residents please add sales tax.



# Gamers' Guide

The Gamers' Guide offers a wide selection of advertisements & notices directed specifically to the game hobbyists.

Ad sizes range from 2" to 5" of column depth (column depth =  $2\frac{5}{16}$ "). The 1 x rate per column inch is \$75. (Example: An ad measuring 3" tall would be calculated as  $\$75 \times 3" = \$225.$ )

Payment for space purchased in the Gamers' Guide must accompany an advertiser's insertion order. Upon receipt of payment and camera-ready copy, the ad will be placed in the next available issue.

For further information, contact Mary Parkinson, TSR, Inc., P.O. Box 756, Lake Geneva, WI 53147.

## SPIRAL ARM

Spiral Arm is our latest play-by-mail game of strategic galactic conquest. Designed by The Australian Wizard, Spiral Arm features a map of over 650 stars, up to 50 players per game, economic production, 7 ship classes, 8 racial types, 4 modes of space movement, space and planetary combat, colonization, and technological development. You can name your Empire and new stars. The customized turnsheet is in a convenient "fill-in-the-blank format" for easy use in submitting orders.

Costs: Rules \$2.50

Turn fees: \$4.50 per turn

Game Entry: \$15.00  
(Set-up and 3 turns)



## FEUDAL LORDS

Feudal Lords is our original, and most popular, play-by-mail game of medieval power politics. Fifteen players struggle to become King of England after the death of King Arthur by means of medieval economic development, military conquest, and diplomatic intrigue. Feudal Lords features agriculture, trade, knights, mercenaries, ships, bribes, spies, and much more.

Costs: Rules \$2.50

Turn fees: \$3.00 per turn

Game Entry: \$10.00  
(Rules, set-up, and 3 turns)

For further information on our games, write to:

**GRAAF SIMULATIONS**  
27530 Harper  
St. Clair Shores, MI  
48081-1924



## IT'S MAGIC !

Now get the games and miniatures you need at outrageously low, rock-bottom prices!!! TSR, Ral Partha, Grenadier, GDW, Avalon Hill and 80 more lines! Why pay more??? We are mail order specialists. Fast Delivery. Satisfaction Guaranteed. Complete Catalog Just \$2.00. Out-of-state don't pay S.C. sales tax.

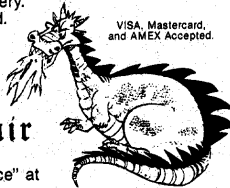

## Dragonslair

TO ORDER: Call "Bruce" at  
1 (800) 22-BRUCE  
P.O. Box 555, Mt. Pleasant, SC 29464

"BRUCE"  
TM

## DREAM WIZARDS

THE SHOP OF THE FANTASTIC—Since 1978

Send \$2 for complete Catalog of all fantasy, science-fiction, military and computer games, miniatures, tarot, gaming aids, magazines and more! Gift miniature with each catalog.

Dept. J

P.O. Box 2246, Rockville, MD 20852  
Phone Orders: (301) 881-3530

When in the Washington D.C. area visit our incredible shop—Congressional Plaza South, Rockville, MD. (across from Twinbrook Metro stop)

## DRAGONBONE

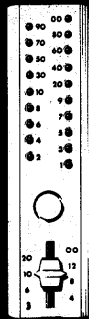

Electronic D3,  
D4, D6, D8, D10,  
D12, D20, D%  
Dice Wand

Comes in Charcoal,  
Bone or Blood  
colors

\$24.95 +\$1.00  
shipping

To order call:  
1-800-228-5287

In Illinois:  
312-257-9010

ALLOW 4 WEEKS DELIVERY



Or mail check or money order to:

**DBE Inc.**  
25 Sunhill Ln.  
Lemont, Ill. 60439

## Your own Full Figure CHARACTER

Rendered by Professional Illustrators · 8½x11

ROLE PLAYING: SUPER HERO  
SCIENCE FICTION, FANTASY

FREE character description sheet.  
(ENCLOSE POSTAGE STAMP)

**ANVIL**  
ENTERPRISES  
P.O. Box 4028  
Indialantic, FL  
32903



## Game Master's Guide™

dungeon master utilities

Creatively design and run FRP games FAST with GAME MASTER'S GUIDE™. Easy to use. Copyable. Listable. Modifiable!

**GMI** — All Dice Rolls, Critical Hits, Fumbles, Combat Tables, Items, Random Functions, Treasures, 14 Shops, storage for 200+ Monsters, 51 Treasures, 51 Characters or NPC's, Dieties Hall and More!

**GMI** — 7 Townes, each with background and multiple functions! 50 Tricks, that are sure to keep your players on their toes! Grand Tournament Grounds, 115 opponents that are always ready for a challenge! Shark Races! Troop generation (1-20k), Hall of Justice and More!

**GMI** — Create NEW, WHOLE Characters and Monsters, each with NAME, all stats, items, attitude, etc. Warring Armies that battle on Screen! 50 Bonus Tricks for GMI and More!

**RAI'MORTH'S HOLLOW™** — Our first computer scenario! Includes: Maps, Keyboard overlay, Detailed Manual. RAI'Morth for the Apple®: \$29.95. GMI for the 512K Macintosh™: \$28.00. GMI: I, II, III for the Apple®, C-64®: \$24.95 each, 2 for \$42.50 all 3 for \$60.00. Add \$1.50 S/H to US and APO. (CK, MO, MC, VISA) US\$. WALTER COMPUTER SERVICES — PO Box 97 Dept. DR, Paradise, PA 17562 or call (717)768-3006.

## The Wizard's Corner

Saskatchewan's FRP Game Centre  
Fantasy, Sci-Fi, & Wargames

801C Broadway Avenue  
Saskatoon, Saskatchewan  
Canada S7N 1B5

NOW with a second location:  
2124B Broad Street  
Regina, Saskatchewan

Drop in to either location, or send \$2  
for catalog to Saskatoon address

## FREE DICE

- D&D® Games, Fantasy Games
- Space, Detective, War Games
- Huge Selection — ALL YOUR GAMING NEEDS
- Japanese Toys, Models & Books
- COMICS — New & Collectable

Send 50¢—refundable with 1st order

## COMIC CASTLE

6512-F El Cajon Blvd.  
San Diego, CA 92115  
Dept. D (619) 265-2124

D&D is a registered trademark of TSR, Inc.



## CAST YOUR OWN FANTASY FIGURES



10 New Molds  
Fantasy Chess Set - Special Figures

**SPECIAL**  
Fantasy Starter Set plus catalog  
only \$11.30 post paid.  
(A Regular \$19.35 Value)

Or send \$1.00 for catalog with color insert

**THE DUNKEN CO.**  
P.O. Box 95D  
Calvert, TX 77837  
(409) 364-2020

Casting your own Figures  
is almost as much fun  
as playing the game.

**\$\$\$ Off**  
YOUR GAMING SUPPLIES

**TSR • Avalon Hill • GDW  
Ral Partha • Koplow • And More**  
For **FREE** Catalog or Order,  
CALL 303/741-2727 OR WRITE  
Mountain Mage  
7871 S. Monaco Ct.  
Englewood, CO 80112

VISA MASTERCARD

Full 144 page original editions of  
**DEITIES & DEMIGODS™**  
cyclopedia

with **ELRIC** of Melnibone and  
**CTHULHU** myths included. These  
rare books sell for up to \$50.00 in  
collector circles, when they can be  
found. Order now and get one for  
only \$35 per copy! We have a  
limited supply and may not be  
repeating this offer.

Brown cover Monster Manuals with  
identical information and page  
layout to current blue cover \$15  
edition...only \$10.

We also sell out of print back issues  
of **DRAGON®** magazine.  
Please include \$2.50 extra with  
order to cover postage. Order from  
**LOU ZOCCHI**  
1512 30th Ave. Box D  
GULFPORT, Mississippi 39501

DEITIES & DEMIGODS and DRAGON are trademarks  
owned by TSR Inc.

**NEW** SPECIAL INTRODUCTORY OFFER **NEW**  
**AGE OF GOLD**  
PBM  
Based on the soon to be released  
**FRP LACHEVA**  
Each turn run personally

Each turn run personally  
Open ended class system  
All classes can cast spells  
weapons, spell, and skill system

**SPECIAL PRICE** **NEVANIS Gamers**  
\$6.50: Rules, set-up 152 Gemmel Ave.  
3 turns (\$2.00 off) Bemidji, MN 56601

**SEARCHING FOR ADVENTURE  
GAMES AND SUPPLIES?**

Forget the monsters — get the

**WARGAMES WEST**

Free Catalog  
Write to:  
**WARGAMES WEST**  
3422 Central Ave. SE  
Albuquerque, NM 87106

RAGNAROK PRESENTS  
**SIEGE AND  
FORTRESS**

This is a new aid for role players and wargamers from the most innovative  
publishers in gaming today. It provides detailed, historically accurate in-  
formation on the design of castles and fortification and the siege and  
capture of those same fortresses. The text is by Lew Bryson, with notes  
and an introduction by Dave Nalle, both of whom have advanced deg-  
rees in history and have lectured on medieval warfare.

**SIEGE AND FORTRESS** covers all the aspects of building, defending,  
and attacking a medieval stronghold, including notes on weapons, mat-  
erials, engineering, economics and logistics. It also contains extensive  
technical appendices with hundreds of maps and plans of historical for-  
tresses. Detailed examples are given, as well as practical hints on the  
use of castles in games and campaigns.

**SIEGE AND FORTRESS** has just been released and can be ordered at  
the special introductory price of only \$4.95 including postage. It is the  
most detailed and complete work of this sort, so order now!

RAGNAROK ENTERPRISES  
1402 21st St. NW Washington, DC 20036

**IMAGINATIVE  
MAIL ORDER**

★ GREAT PRICES ★

RAL PARTHA JAMES BOND  
GRENADIER CAR WARS  
TSR MORE!

FAST SERVICE!  
Send \$1 for Catalog  
(Refundable with first order!)

Box 100  
Hawleyville, CT. 06440

**DIAMOND DICE, Inc.**  
324 S. Fairview, Park Ridge, IL 60068  
(312) 692-7165

All orders add \$1.00 for postage/Send \$1.00 for Catalog

## MASTER DICE SETS (6 different dice)

**BONUS — 6 FREE 20 sided dice with each  
set ordered**

94	Black Dice/Silver Ink	\$6.60
108	Diamond Dice/Blue Ink	\$7.50
112	Transparent Blue Dice/Silver Ink	\$7.50
115	Transparent Purple Dice/Silver Ink	\$7.50
8001	Diamond Dice Uninked	\$4.50
8008	Transparent (Frosted) Uninked 6 Different Colors	\$4.50
1004	100 Transparent Assorted Dice (GOOD VALUE)	\$19.00
0001	8 Assorted Transparent Inked JUMBO Dice	\$6.00

## Index to advertisers

Name of firm or product	Page(s)
Adventure Systems	13
Armory, The	Inside back cover
Avalon Hill Game Co., The	11
Bard Games	13
Castle Creations	38
Chaosium, Inc.	5
Compleat Strategist, The	20
Doubleday SF Book Club	7
DRAGON* Magazine	40, 69
Fantasy Games Unlimited	17, 70, 83, 93
Fantasy-Wear	29
FASA Corp.	21
Game Designers' Workshop	31
Game Systems Inc.	34
Gamers' Guide	94-95
Games Workshop U.S.	71, inside front cover
Iron Crown Enterprises, Inc.	1, 89, back cover
Palladium Books	9, 39
R. Talsorian	38
Ral Partha Enterprises, Inc.	37
Sky Realms Publishing	17
Steve Jackson Games	23
Task Force Games	67
TSR, Inc.	76
TU-E Games	87
Wizards Nook, The	33

## Write on!

Got a question about an article? A subject you'd like us to cover — or *not* cover? What do you think of the magazine you're reading? Drop us a line at "Letters," P.O. Box 110, Lake Geneva WI 53147. We'll read every letter we get, and we'll select certain letters of general interest for publication — maybe even *yours!*

# Convention Calendar

## NYCLONE, July 11-13

This convention will be staged at the Hyatt Regency Hotel in New Brunswick, N. J. Guest of honor will be Alexis Gilliland; other guests will include Sharon Green, Brian Wilkes, and Susan Schwartz. Registration fees are \$25. For more details about this event, contact: NYClone, P.O. Box 608, Belle Mead NJ 08502.

## COLONIAL CITY GAMEFEST '86, July 12-13

This convention will be staged at the Memorial Building in Mt. Vernon, Ohio. All types of games, miniatures events, and a model painting content will be offered. For more details, contact: The Mt. Vernon Gamers' Association, 205 W. Gambier St., Mt. Vernon OH 43050.

## SPOKON '86, July 18-20

This science-fiction and fantasy convention will be held at the Ridpath Hotel in Spokane, Wash. For more information about this convention, send a self-addressed, stamped envelope to: S.A.I.F., P.O. Box 9582, Spokane WA 99205.

## SSC JERSEY DEVILCON, July 18-20

To be held at Stockton State College in Pomona, N.J., this convention will feature a costume contest and a trivia contest. Preregistration fees are \$10, and registration fees are \$13. Send a self-addressed, stamped envelope to: Don Glidewell, Office of Campus Activities G-202, Stockton State College, Pomona NJ 08240.

## DOVERCON II, July 19-20

This convention will be staged at the Dover Municipal Building Auditorium in Dover, N.H. Featured events will include D&D® and AD&D® tournaments and Diplomacy events. Artwork and miniatures will be judged, and winners will be awarded. Dealer inquiries welcome. Registration fees are \$5 for single-day attendance, and \$8 for the weekend. For details, contact: DoverCon II, P.O. Box 622, Dover NH 03820.

## WINDSOR GAMEFEST IV, July 19-20

This convention will be held in Ambassador Hall at the University of Windsor in Windsor, Ontario. Featured events include role-playing, miniatures and board games, free movies, and a dealers' area. Registration fees are \$10 in Canadian funds for a weekend pass, and \$7 in Canadian funds for a daily pass. For additional details about this event, contact: WRPA Head Office, 584 Brighton Road, Windsor, Ontario, Canada N8N 2L6.

## ATLANTA FANTASY FAIR XII, July 25-27

This comics/gaming/science-fiction convention will be held at the Omni Hotel and Georgia World Congress Center in Atlanta, Ga. Guests of honor include Ralph Bakshi, Boris Vallejo, Greg Hildebrandt, Stan Lee, Diane Duane, and Steve Jackson. Registration fees are \$29. For details, send a self-addressed, stamped envelope to: A.F.F., P.O. Box 566, Marietta GA 30061.

## OMACON 6, Aug. 1-3

This science-fiction and gaming convention will be staged at the Holiday Inn Central in Omaha, Neb. Guests of honor will include Alan Dean Foster, Art Bozlee, and Roger Stern. For more information, contact: Omacon 6, P.O. Box 37654, Omaha NE 68137.

## THE WIZARD'S CHALLENGE '86, Aug. 1-3

This fourth annual gaming event will take place at the Holiday Inn in Saskatoon, Saskatchewan, Canada. An AD&D® tournament, demonstration games, and miniatures events will be featured. The registration fees are \$5. For details, contact: The Wizard's Corner, 801C Broadway Avenue, Saskatoon, Saskatchewan, Canada S7N 1B5.

## KAL-KON '86, Aug. 2-3

To be staged at Eason Hall in Westfield, N.Y., this convention will offer tournaments for the AD&D®, Traveleer, Star Fleet Battles, Car Wars, TOP SECRET®, and GAMMA WORLD® gaming systems. Dealers' tables will be available, and dealers are encouraged to attend. For more information about this convention, send a self-addressed, stamped envelope to: Gamer's Connection, P.O. Box 822, Jamestown NY 14702-0822

## MADNESS '86, Aug. 9-10

This comic book, gaming, and science-fiction convention will be held at Middletown High School in Middletown, N.Y. Preregistration fees are \$8, and registration fees are \$10 at the door. For more details, send a self-addressed, stamped envelope to: Madness '86, 9 Sheffield Drive, Middletown NY 10940.

## VALLEYCON '86, Aug. 9

This science-fiction, gaming, and comic book convention will be held at the Veteran's Memorial Building in Tulare, Calif., from 10:00 A.M. to 8:00 A.M. There will be open and organized gaming, movies, exhibits, speakers, a dealers' room, and

costume and trivia contests with cash prizes. Registration is free. For more information, contact: Big Mike's Video, 1766 E. Tulare Ave., Tulare CA 93274.

## GEN CON® 19 GAME CONVENTION, Aug. 14-17

This annual gaming convention, sponsored by TSR, Inc., will be staged at the MECCA Auditorium and Convention Hall in Milwaukee, Wis. For information, contact: Marti Hayes, P.O. Box 756, Lake Geneva WI 53147-0756.

## ARACNACON IV, Aug. 28-31

This gaming convention will be staged at the Melbourne College of Advanced Education in Carlton, Melbourne, Australia. Featured events include a variety of tournaments, a masquerade, videos, a convention dinner, and a dealers' room. For more information, contact: Aracnacon IV, P.O. Box 312, Glenroy 3046, Australia.

### Convention Calendar Policies

In order to ensure that all convention listings contain accurate and timely information, all material should be either typed double-spaced or printed legibly on 8½" by 11" paper. The contents of each listing must **not** exceed 70 words in length.

The information given in the listing **must** be prepared in the following format:

- 1) title and date (not to exceed 2 lines of printed matter),
- 2) site and location,
- 3) guests of honor (if applicable),
- 4) special events offered,
- 5) registration fees or attendance requirements.
- 6) address (telephone number optional) where additional information can be obtained.

### Sample listing:

#### EVERYCON, Sep. 1-3

This gaming event will take place in Nowhere, Ind. Fred Smith and Jane Doe are guests of honor. Role-playing games and miniatures events will be featured. Registration is free. For details, contact: EveryCon, P.O. Box 000, Nowhere IN 46000.

Convention flyers, brochures, newsletters, and other mass-mailed announcements will not be considered for this column and will be discarded. We reserve the right to edit listings, but we are not responsible for updating them.

All listings must be accompanied by a cover letter which includes both an address and a telephone number. We are not, though, responsible for incorrect information provided to this office. If a cover letter is not provided, the listing will not be printed. No call-in listings will be accepted.

Foreign and domestic listings are welcome.

Convention listings should be mailed by the copy deadline date to Kim Mohan, Convention Listings Coordinator, c/o DRAGON® Magazine, P.O. Box 110, Lake Geneva WI 53147.

Copy deadline dates are the last Monday of each month, two months prior to the on-sale date of an issue. For example: The copy deadline for the September 1986 issue is the last Monday of July 1986.

For any questions related to the Convention Calendar, please contact Mr. Mohan at (414) 248-3625.



# SNARFQUEST

# 96

BY ELMORE

© ELMORE '86

WELL, SNARF, NOW THAT YOU GOT RID OF THAT OL' GATHGOR, WE MUST QUICKLY FIND HIS TREASURE.



MOMENTS LATER...

WOW!

BLEEP!



LOOK, DAT IS ALL DER IS LEFT OF POOR OL' JARP.

LET'S PUT HIS REMAINS IN THIS GOLD VASE.

YEAH, HE WOULD'VE LIKED DAT.



LOOK, A DOOR HIDDEN BEHIND THIS TAPESTRY. PERHAPS IT LEADS TO THE TREASURY.

YOU BIT GATHGOR, DIDN'T YOU?

YEP.



MY BACK PACK IS MAGICAL, IT WILL HOLD AS MUCH AS A LARGE CHEST, AN' NOW IT IS FULL!

ME AN' AVEEARE WILL CARRY DA CHEST, NOW LET'S FIND A WAY OUTTA HERE!

BLEEP



I THINK WE GOT ALL DA MOST VALUABLE LOOT.

DA RED ONES TASTE GOOD.

SNARF... WE'RE RICH BEYOND OUR WILDEST DREAMS!



LATER

HOW ARE WE GONNA ESCAPE? WE CAN'T GO BACK DA WAY WE CAME, TOO MANY GUARDS.

THE SECRET PASSAGE THAT WE CAME THROUGH IS ONE HUGE MAZE.

I'M HEARING DAT VOICE AGAIN, AVEEARE DAT E.S.P. VOICE.

IT LOOKS AS IF WE ARE IN A HIGH MOUNTAIN, BUT WE CAN CLIMB DOWN. WE NEED PLENTY OF ROPE.

THERE'S GOT TO BE A WAY OUT.

WE COULD GET LOST IN THERE.

WHAT DOES IT SAY?

I SAW A LOT OF ROPE EARLIER. I THINK IT'S OVER IN THAT CORNER.

YOU LOOK LIKE A TWO DOLLAR PIMP.

SNARF, YOU IDIOT, TRY DA WINDOW.

TRY DA WINDOW.

WELL, I'M GONNA TAKE OFF SOME OF DIS DISGUISE SO I CAN CLIMB.

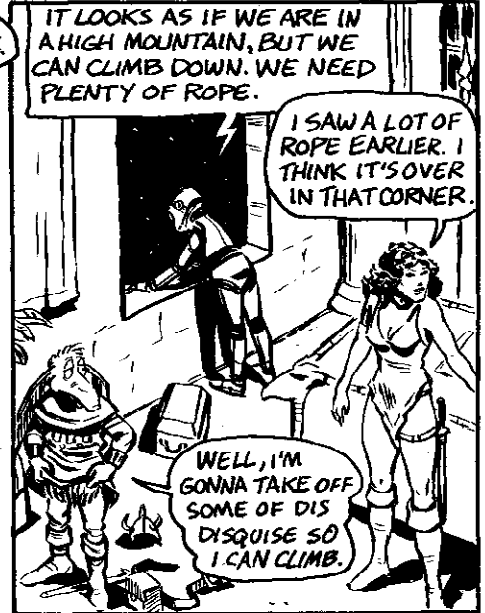

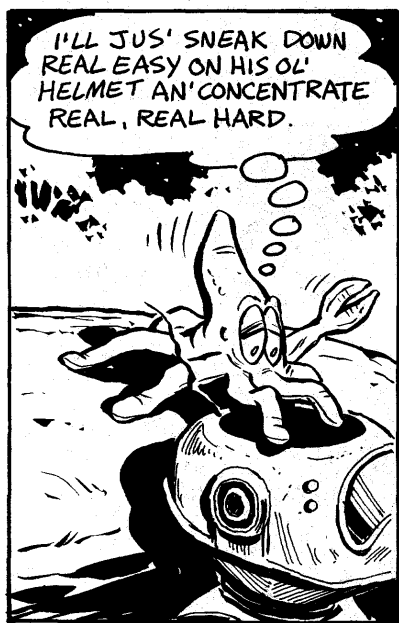

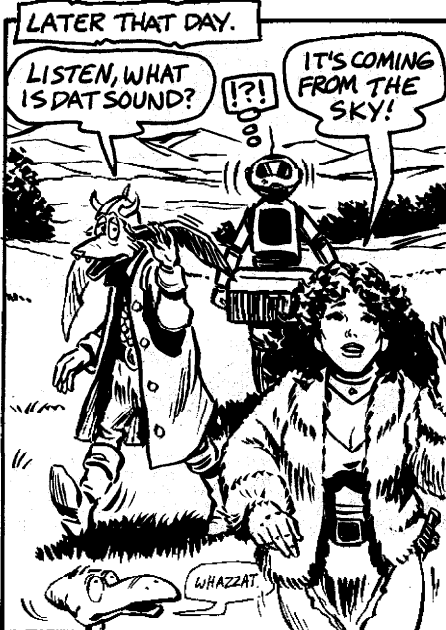
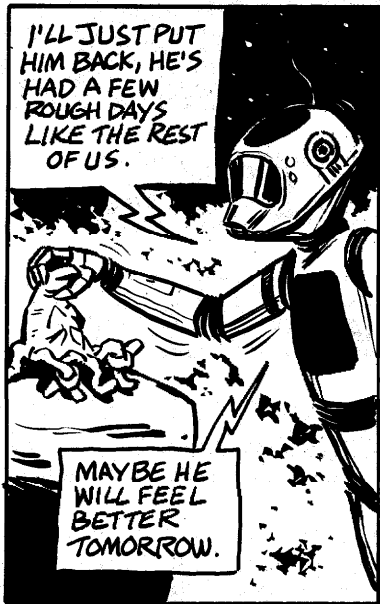
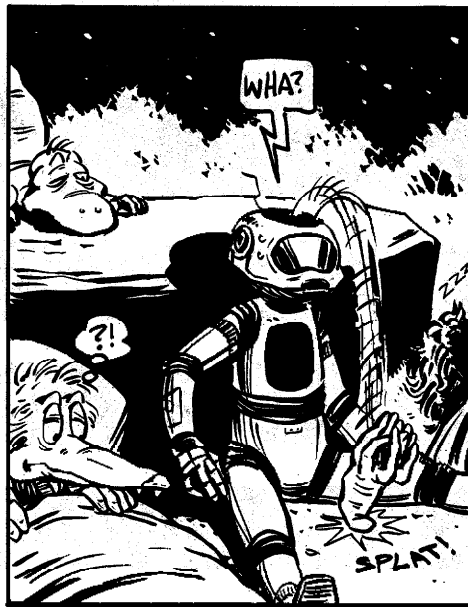
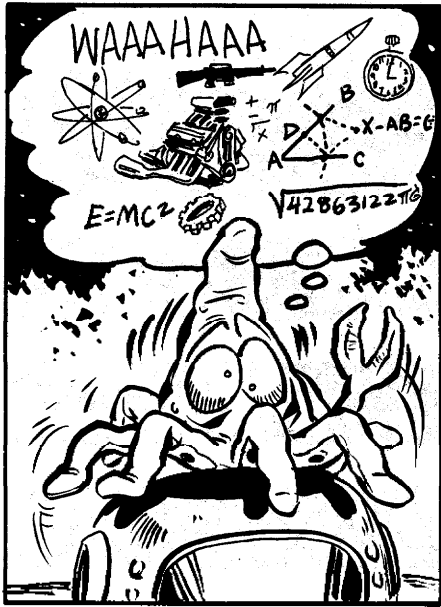

# Dragonmirth



"WHAT'S IT GOING TO BE, MR. AND MRS. HUDSON? CHAMBER NUMBER ONE, CHAMBER NUMBER TWO, OR CHAMBER NUMBER THREE?"

BRUNO DISCOVERS THE ANCIENT CURSE ON THE PYRAMID. . .

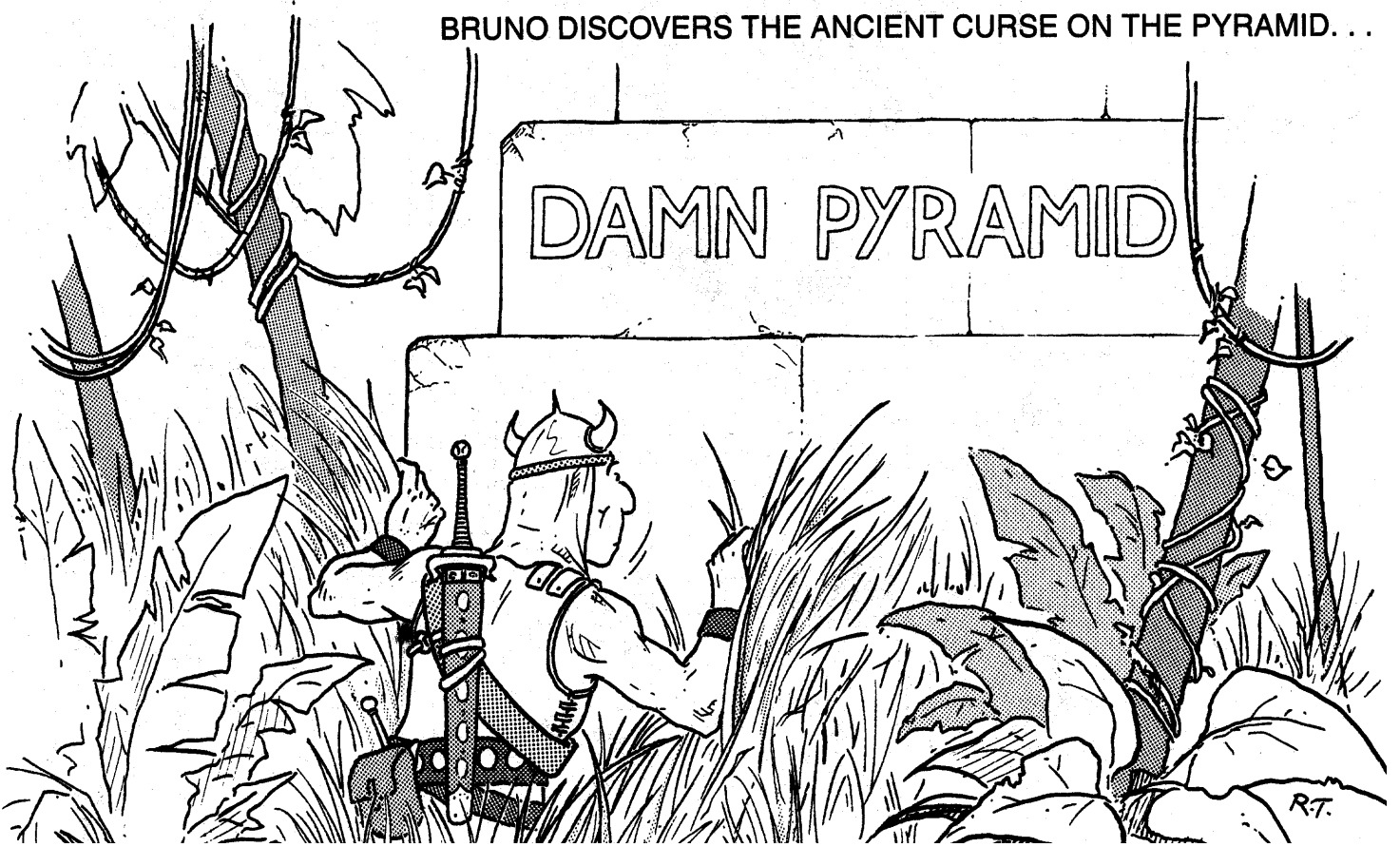



"LUCKILY, HE MADE HIS SAVE AND ONLY TOOK HALF DAMAGE."

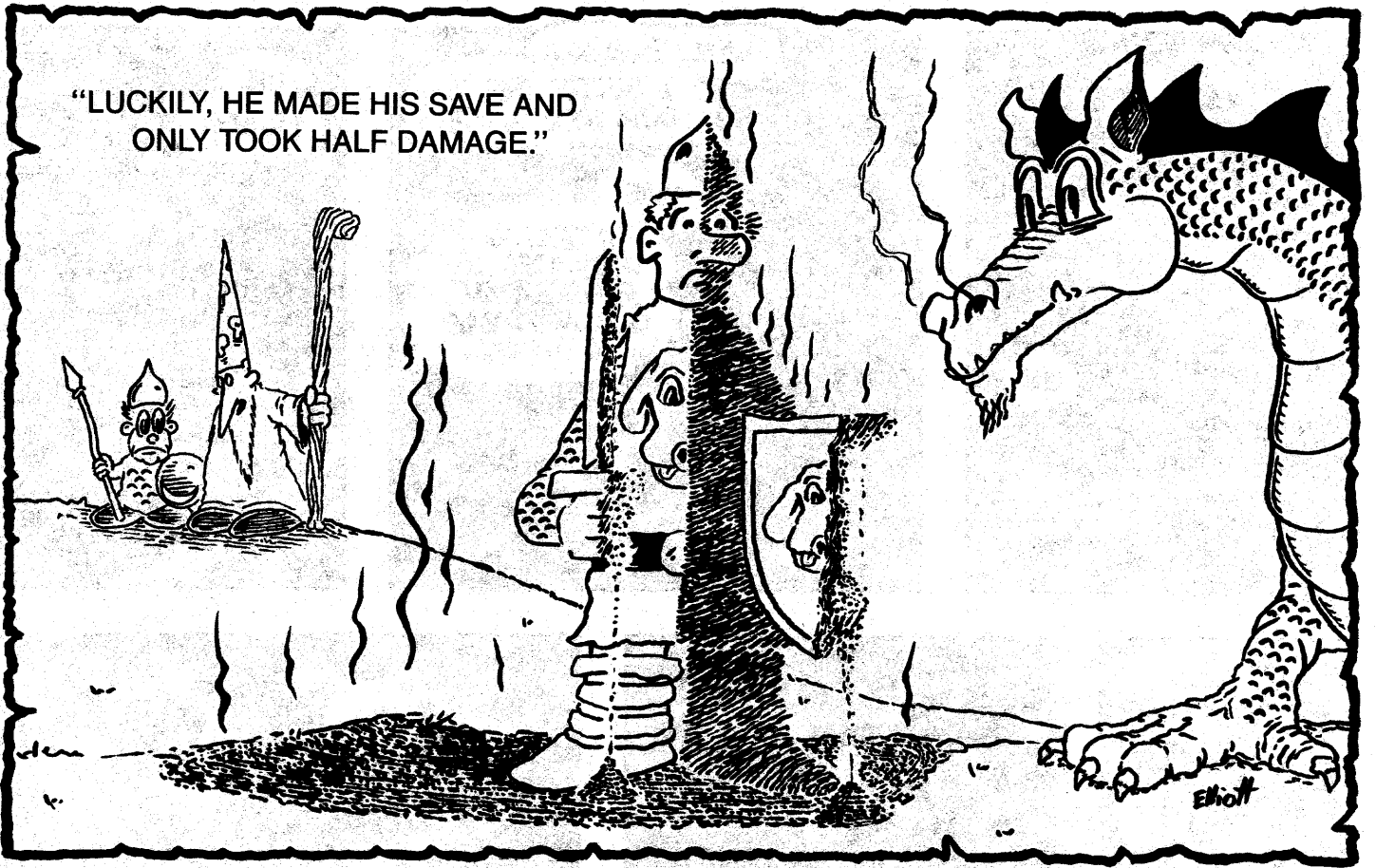

"... DARNDDEST THING I'VE EVER SEEN!  
THE DICE JUST SORTA DISAPPEARED  
WHEN I WUZ ROLLIN' MY CHARISMA ..."

















**NEW  
ARMORY  
PAINT SET**

# METALLIC

**Paint  
SET  
II**



**The Armory Paint Sets**  
\$10.95 each

CONTAINS 8 1oz. JARS  
OF OUR NEW COLOR  
METALLICS!



**The Armory**

MANUFACTURERS AND IMPORTERS OF DICE  
DICE INKERS DICE MARKERS DICE POUCHES  
PAINT BRUSHES & GAMING ACCESSORIES

**Paint Set**

CONTENTS: 8-1oz. JARS  
SPECIALLY FORMULATED FOR METAL MINIATURES  
ALSO SUITABLE FOR PLASTIC MODELS AND GENERAL HOBBY USE

**POLYMER PAINT  
WATER BASED  
NON TOXIC  
NON-FLAMMABLE**

## ARMORY PAINT SETS ARE AVAILABLE FROM THESE FINE STORES.

CITY	STORE NAME	ADDRESS	PHONE	CITY	STORE NAME	ADDRESS	PHONE
AL - BIRMINGHAM	Lion & Unicorn Inc.	1915 11th Ave.	(933-0777)	NC - HAVELock	Readers Haven	Slocum Valley Square	(447-1355)
AL - DALEVILLE	Book Chest	238 Daleville Ave.	(598-4221)	NC - WINSTON SALEM	J And S Hobbies & Crafts	712 Naughton St.	(788-3046)
AL - HOMEWOOD	HomeWood Toy & Hobby	2830 S. 18th Str.	(879-3986)	MI - NEW BALTIMORE	Fantasy Castle	50979 Washington	(725-2150)
CA - BAKERSFIELD	Comics & Characters	3217-B Miles Str.	(366-8122)	NC - CHARLOTTE	Dragon's Nest Inc.	North Park Mall	(596-9465)
CA - FORT BRAGG	Dragon's Lair	219 N. McPherson St.	(964-5070)	NJ - MONTCLAIR	Compleat Strategist	215 Glenridge Ave.	(744-6622)
CA - MERCED	Hobby Castle	60 W. Olive Ave.	(723-6662)	NJ - OLD BRIDGE	Adventure Hobbies	596 Englishtown Rd.	(251-2030)
CA - PASADENA	The Gaming House	1260 E. Colorado Blvd.	(449-9107)	NJ - WHITESBORO	Pat's	K's Indoor Mart Rt. 9	(522-9426)
CA - ROSEVILLE	Puzzle Box	1000 Sunrise Ave Suite 10B	(781-2666)	NM - AZTEC	Charlies Hobbies	218 N. Main St.	(334-3703)
CT - HAMPTON	Flock Stock & Barrel	Rt. 6.	(455-0272)	NY - BUFFALO	Dragon's Dice	5 W. Northrop Pl.	(837-1121)
CT - STORRS	Flock Stock & Barrel	1254 Storrs Rd.	(429-9107)	NY - NEW YORK	Compleat Strategist	11 East 33rd.	(685-3880)
CT - WEST HARTFORD	War & Pieces	7 S. Main St.	(232-0608)	NY - NEW YORK	Compleat Strategist	320 West 57th St.	(582-1272)
DE - CLAYMOUNT	Book Thrift	Iri State Mall	(798-3378)	NY - ITHACA	Quest's End	220 The Commons	(272-2221)
DE - NEWARK	Days of Knights	58 E. Main St.	(366-0963)	NY - PLATTSBURGH	The Command Post	14 Brinkerhoff St.	(561-5033)
FL - BRADENTON	Time Machine	3320 Manatee Ave. W.	(748-4879)	NY - SYRACUSE	Twilight Books & Games	1411 N. Saline St.	(471-3139)
FL - BRADENTON	Time Machine II	5748 W. 14th St.	(758-3684)	OH - AKRON	Little Shop of War	5 Merriam Rd.	(374-0814)
FL - CLEARWATER	Modelers Mart	2071 Range Rd.	(443-3822)	OH - DAYTON	The Tin Soldier	6159 Far Hills Ave.	(435-3295)
FL - FT. WALTON BEACH	Dave's Hobbies	700 D.Beal Parkway	(862-2014)	OH - KENT	Spellbinders	136 E. Main St. Suite 6	(673-2230)
FL - MIAMI	Hobbyland	18455 S. Dixie Hwy.	(238-4387)	OH - PAINESVILLE	Danielson Dungeon	1480 Thatcher Dr.	(735-5490)
FL - NEPTUNE BEACH	Hobby Oasis	540 Atlantic Blvd.	(249-2066)	OR - PORTLAND	Military Corner	2725 N.E. Broadway	(287-6088)
FL - OAKLAND	Adventure Games	1001 W. Oakland Pk. Blvd	(561-1434)	PA - KING OF PRUSSIA	Compleat Strategist	254 W. Dekalb Pike	(265-8562)
FL - ORLANDO	Enterprise 1701	2814 Corrine Dr.	(896-1701)	PA - LEBANON	Spellbound Hobbies	814 Cumberland St.	(273-7834)
FL - PALM BAY	Dragons Den	2020 Palm Bay Rd.	(768-0673)	PA - LEMOYNE	The Magic Shop	829 J State St.	(737-7559)
FL - TALLAHASSEE	The Grinning Gremlin	824 W. Tharpe St.	(358-1518)	PA - PHILADELPHIA	Compleat Strategist	2011 Walnut St.	(563-2960)
GA - ATLANTA	Sword of The Phoenix	Lenox Square Mall	(231-4244)	SC - N. CHARLESTON	Green Dragon	D-15 Charleston Mall	(744-8783)
IA - CEDAR RAPIDS	Pookoo Games	3421 Mt. Vernon Rd S.E.	(362-6120)	TN - MADISON	The Great Escape	01d Town Village	(865-8052)
IA - DES MOINES	Fantasy Game Shop	2306 1/2 University	(274-2521)	TN - MEMPHIS	Raleigh Hobbies	4970 Raleigh Lagrange	(377-1129)
IL - GRANITE CITY	Mini Mall Hobbies	Mini Mall Shopping Ctr.	(877-8099)	TX - ARLINGTON	Lone Star Comics & Sci Fi	511 E. Abram	(265-0491)
IL - MT. PROSPECT	Games Plus	20 W. Busse Ave.	(577-9656)	TX - DALLAS	Lone Star Comics & Sci-Fi	7738 Forest Lane	(373-0934)
IN - ELKHART	Adventure's Quest	2005 Cassopolis	(262-2121)	TX - EL PASO	Rita's Paperback Book Exch.	34 Sunrise Shopping Ctr.	(757-1143)
IN - ELWOOD	Metalcraft Miniatures &	More 1000 N. 9th St.	(552-2073)	TX - IRVINE	Lone Star Comics & Sci-Fi	2550 N. Beltline Rd.	(659-0317)
IN - INDIANAPOLIS	The Game Preserve	6101 N. Keystone	(257-7116)	TX - LUBBOCK	Gizmo's	4401 82nd St.	(794-2068)
KS - OVERLAND PARK	Clint's South	9601B Metcalf Sq.	(381-4213)	TX - LUBBOCK	Star Books & Comics	2014 34th St.	(744-9150)
KS - WICHITA	Fantasci	4015 W. 13th St.	(942-5705)	TX - GRAPEVINE	Triple R Hobby Shop	422 S. Main St.	(481-5345)
KY - HOPKINSVILLE	Hobbysoph #2	Pennyrile Mall	(886-5747)	TX - MESQUITE	Lone Star Comics & Sci-Fi	144-146 Town E. Mall	(681-2040)
KY - LOUISVILLE	The Great Escape	2433 Bardstown Rd.	(456-2216)	VA - CHARLOTTESVILLE	The Standard Bearer	8 University S/C	(979-5545)
KY - RADCLIFF	The Bookstore	Radcliff Plaza	(351-1801)	VA - FAIRFAX	What's Your Game	Fair Oaks Mall	(591-7242)
LA - BATON ROUGE	Elliott's Book Shop	3060 College Dr.	(942-1060)	VA - FALLS CHURCH	Compleat Strategist	103 E. Broad St.	(532-2477)
LA - LEESVILLE	Computer & Hobby Center	105 S. 3rd St.	(239-0757)	VA - HAMPTON	Campaign Headquarters	47 E. Queensway Mall	(723-8433)
LA - SLIDELL	Limited Wish	544 Old Spanish Trail	(643-4060)	VA - NORFOLK	Campaign Headquarters	145 E. Little Creek Rd.	(583-9451)
MA - BOSTON	Compleat Strategist	201 Massachusetts Ave.	(267-2451)	VA - NORFOLK	Triology Shop	340 E. Bayview Blvd.	(587-2540)
MA - N. ATTLEBORO	Toy Depot	570 Kelley Blvd.	(695-1672)	VA - RICHMOND	One-Eyed-Jacques	3104 W. Cary	(359-5163)
MA - NEWBURYPORT	Toy Soldier #2	19A Inn St.	(462-8241)	VA - SPRINGFIELD	What's Your Game?	Springfield Mall	(971-5951)
MD - BALTIMORE	What's Your Game	Harbor Place	(685-0008)	VA - STAUNTON	SES Services	P.O. Box 2672	(885-5530)
MD - COCKEYSVILLE	Alternate Worlds	9924 York Road	(667-0440)	VA - STERLING PARK	Wargames Hobby Shop	Holly Plaza United 16	(450-6738)
MD - COLUMBIA	Patowmack Toys	1254 Columbia Mall	(730-0977)	VA - VIRGINIA BEACH	Triology Shop	5773 Princess Anne Rd.	(490-2205)
MD - HAGERSTOWN	Masters Hobby	615 Dual Highway	(739-1933)	WA - BREMERTON	The Gamemasters	2202 E. 11th St.	(373-3269)
MI - EAST LANSING	Riders Hobby Shop	920 Trowbridge Rd.	(332-6880)	WA - RAYMOND	Pacific Wholesale	147 S. 3rd. St.	(427-2223)
MO - COLUMBIA	Rockbottom Books & Comics	1019 E. Walnut	(443-0113)	WA - RENTON	Heritage Book Shop	Renton Shopping Ctr.	(271-1776)
MO - KANSAS CITY	Clint's Books	3943 Main St.	(561-2848)	WV - HARPERS FERRY	Depot Hobby Shop	High Street	(535-6610)
MO - OVERLAND	Games Crafts & Hobbies	9220 Lackland Rd.	(423-2199)	WV - PARKERSBURG	The Golden Gryphon	219 6th St.	(422-6787)
MI - GREAT FALLS	Hobby World	Holiday Village Mall	(727-1010)				

# Adventure beckons... come to MIDDLE-EARTH®

with Fantasy Role Playing products from  
IRON CROWN ENTERPRISES

**MIDDLE-EARTH ROLE PLAYING™** (MERP) is perfect for seasoned gamers looking for a realistic, easy-to-play system. MERP works equally well for those who have never experienced the thrill of Fantasy Role Playing. Designed with faithful attention to Tolkien's world, MERP provides rules covering combat, magic, professions, and everything necessary for adventuring in the greatest fantasy world of all time!

Copyright © 1986 TOLKIEN ENTERPRISES. THE HOBBIT™ & THE LORD OF THE RINGS™ and all characters and places therein are trademark properties of TOLKIEN ENTERPRISES.

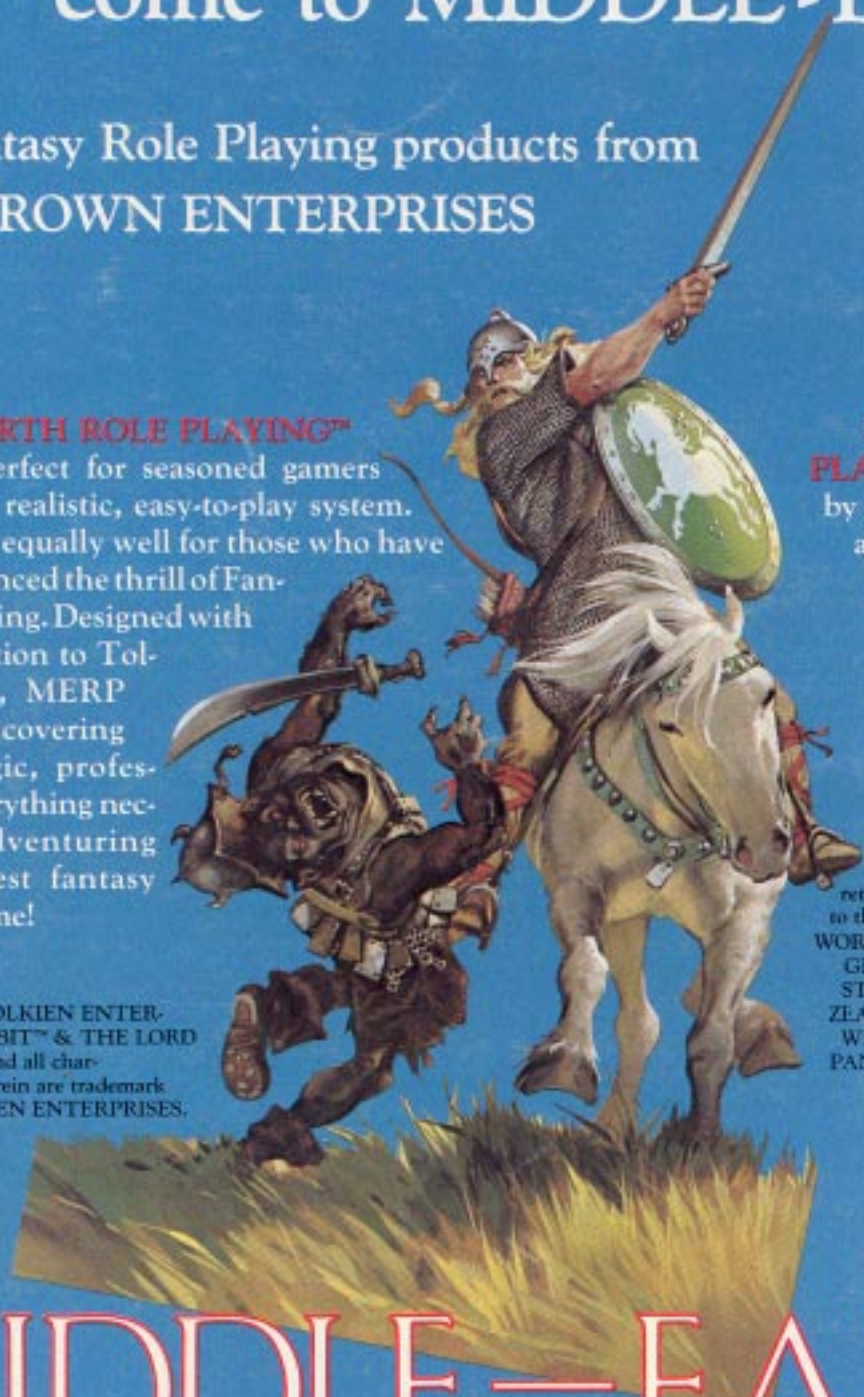

**MIDDLE-EARTH ROLE PLAYING™** is well supported by a wide variety of aids and adventures. Look for these products wherever games are sold!

These excellent products are sold at retail outlets worldwide. Sold exclusively to the hobby trade in the UK by GAMES WORKSHOP, in SCANDINAVIA by TARGET GAMES AB of Stockholm, in AUSTRALIA by JEDKO GAMES, in NEW ZEALAND by BLACKWOOD GAYLE, in WEST GERMANY by CITADEL, in JAPAN by POST HOBBY CO., LTD. and in ITALY by PACIFIC ENTERPRISE ITALIA.

# MIDDLE-EARTH ROLE PLAYING™

## ...A WORLD APART



PRODUCED & DISTRIBUTED BY IRON CROWN ENTERPRISES / P.O. BOX 1605 / CHARLOTTESVILLE, VA 22902